

Storm Drainage Calculations

PRESERVE AT JONES DAIRY CENTRAL
Rolesville, North Carolina

September 16, 2022
Revised December 12, 2022
Revised January 24, 2023
Revised May 3, 2023
Revised January 19, 2024



Prepared By:

The Nau Company, PLLC
PO Box 810
Rolesville, North Carolina, 27571
(919) 625-3090
tnau@thenauco.com
NCBELS License # P-0751

Storm Drainage Calculations

January 19, 2024

Preserve at Jones Dairy Central

INTRODUCTION

This report presents the storm drainage design for the proposed improvements at the Preserve at Jones Dairy North project located on parcels bounded by Jones Dairy Road and Averette Road in Rolesville, North Carolina.

BACKGROUND

The Preserve at Jones Dairy Central project is comprised of approximately 88.6 acres of land that is currently undeveloped. At full build-out, the proposed subdivision will consist of 260 single family lots and 179 townhome units. Water and sewer services will be provided by the City of Raleigh. The proposed subdivision will have two stormwater control measures (SCMs) that will meet Town and State requirements for stormwater quality. All roads will be Town maintained roads. The proposed roads will utilize storm sewer piping to convey runoff to the SCM.

METHODOLOGY

General

All calculations were performed in accordance with NCDOT requirements including those in the Guidelines for Drainage Studies (1999 Edition).

Runoff

Peak flow runoff rates were calculated using the Rational Formula. Rational runoff coefficients were determined for each inlet based on generalized land use conditions encountered for this project. A minimum time of concentration equal to 10 minutes was used for each inlet due to the relatively small drainage area for each inlet. Rainfall intensities were based on the time of concentration to the inlet.

Storm Drainage Piping

Storm sewer pipes were designed for the 10-year storm using Hydrology Studio/Stormwater Studio. The primary computational methodologies by the software are methods described in FHWA HEC-22. Runoff to each inlet was determined by the rational method. The minimum pipe size for this project is 15 inches.

Inlets and Gutter Spread

Gutter spread for this project was calculated by Hydrology Studio/Stormwater Studio which follows the methodology of FHWA HEC-22. The 4 inch per hour storm was used to calculate the runoff to each inlet. Inlet data used in the software was based on NCDOT frames/grates/hoods shown in NCDOT detail 840.03. The desirable gutter spread was limited to one half of a travel lane.

Pipe Hydraulic Grade Line

The hydraulic grade line (HGL) for this project was calculated by Hydrology Studio/Stormwater Studio which uses the energy-based Standard Step method. The storm systems were designed to maintain the HGL within the pipe for the 10-year storm.

APPENDICES

Appendix A – Drainage Area Map

Appendix B – Storm Sewer and Runoff Calculations

Appendix C – Storm Sewer HGL Calculations

Appendix D – Storm Sewer Gutter Spread Calculations

APPENDIX A – DRAINAGE AREA MAPS

APPENDIX B – STORM SEWER AND RUNOFF CALCULATIONS

Storm Sewer Tabulation

Project Name: Enter Project Name...

Stormwater Studio 2024 v 3.0.0.33

01-19-2024

Line ID	Length (ft)		Drng Area (ac)		Rational (C)	C x A		Tc (min)		Intensity (in/hr)	Total Q (cfs)	Capacity (cfs)	Velocity (ft/s)	Line		Invert Elev (ft)		HGL Elev (ft)		Surface Elev (ft)		Line No
	Incr	Total	Incr	Total		Inlet	Syst	Incr	Total					Size (in)	Slope (%)	Up	Dn	Up	Dn	Up	Dn	
101 TO 100	0.070	54.968	0.80	34.86	5.0	11.04	0.06	34.86	5.0	11.04	193.00	242.20	11.04	66	0.52	388.18	387.92	391.99	391.70	399.63	399.00	1
102 TO 101	0.080	28.822	0.80	17.75	5.0	10.97	0.06	17.75	5.0	10.97	98.51	101.66	9.08	48	0.50	389.85	389.68	393.06	392.91	399.63	399.63	2
103 TO 102	0.180	14.772	0.70	9.92	5.0	10.91	0.13	9.92	5.0	10.91	55.18	142.25	9.35	42	2.00	391.40	390.45	393.67	392.35	398.55	399.63	3
104 TO 103	0.170	14.202	0.70	9.52	5.0	10.86	0.12	9.52	5.0	10.86	53.05	140.93	11.34	36	4.47	394.17	391.90	396.49	393.52	399.27	398.55	4
105 TO 104	0.250	14.032	0.70	9.40	5.0	10.71	0.18	9.40	5.0	10.71	52.66	66.72	9.36	36	1.00	395.17	394.27	397.48	396.42	401.19	399.27	5
106 TO 105	0.360	13.782	0.70	9.23	5.0	10.66	0.25	9.23	5.0	10.66	51.78	66.69	9.10	36	1.00	395.61	395.27	397.90	397.48	401.19	401.19	6
107 TO 106	0.140	13.422	0.70	8.98	5.0	10.45	0.10	8.98	5.0	10.45	50.74	81.66	9.92	36	1.50	397.89	395.71	400.16	397.57	404.22	401.19	7
108 TO 107	0.320	12.612	0.70	8.41	5.0	10.32	0.22	8.41	5.0	10.32	47.75	66.59	8.94	36	1.00	399.59	398.85	401.79	400.90	406.08	404.22	8
109 TO 108	0.300	12.292	0.07	8.19	5.0	10.00	0.02	8.19	5.0	10.00	47.00	66.74	7.92	36	1.00	401.54	399.69	403.73	402.25	411.62	406.08	9
110 TO 109	0.590	11.992	0.70	8.17	5.0	9.95	0.41	8.17	5.0	9.95	46.97	66.69	7.96	36	1.00	401.98	401.64	404.16	404.17	411.62	411.62	10
111 TO 110	0.100	11.402	0.70	7.75	5.0	9.79	0.07	7.75	5.0	9.79	44.85	66.63	8.76	36	1.00	402.98	402.08	405.11	404.04	414.50	426.00	11
112 TO 111	0.100	11.302	0.70	7.68	5.0	9.61	0.07	7.68	5.0	9.61	44.74	66.64	8.80	36	1.00	404.13	403.08	406.26	405.02	418.20	414.50	12
113 TO 112	0.001	10.902	0.80	7.40	5.0	9.23	0.00	7.40	5.0	9.23	43.72	63.28	7.58	36	0.90	406.18	404.23	408.29	406.74	419.06	418.20	13
114 TO 113	0.100	10.901	0.70	7.40	5.0	9.12	0.07	7.40	5.0	9.12	43.90	66.41	7.66	36	0.99	406.91	406.28	409.02	408.74	419.05	419.06	14
115 TO 114	0.001	10.431	0.80	7.07	5.0	8.93	0.00	7.07	5.0	8.93	42.25	66.83	7.39	36	1.00	408.13	407.01	410.20	409.53	422.70	419.05	15
116 TO 115	0.140	10.140	0.70	0.10	5.0	5.00	0.10	0.10	5.0	5.00	0.69	6.46	2.96	15	1.00	416.70	416.11	417.03	416.39	425.37	422.70	16
117 TO 115	0.120	10.290	0.70	6.97	5.0	8.72	0.08	6.97	5.0	8.72	41.98	66.61	7.45	36	1.00	409.40	408.23	411.47	410.68	422.30	422.70	17
118 TO 117	0.110	8.810	0.70	6.00	5.0	8.55	0.08	6.00	5.0	8.55	36.36	41.01	8.81	30	1.00	410.90	409.90	412.92	411.81	421.30	422.30	18
119 TO 118	0.120	8.700	0.70	5.92	5.0	8.49	0.08	5.92	5.0	8.49	35.97	40.78	8.15	30	0.99	411.29	411.00	413.30	413.22	421.16	421.30	19
120 TO 119	0.270	8.580	0.70	5.84	5.0	8.41	0.19	5.84	5.0	8.41	35.57	41.20	8.64	30	1.01	411.86	411.39	413.85	413.31	420.29	421.16	20
121 TO 120	0.250	6.950	0.70	4.70	5.0	8.36	0.18	4.70	5.0	8.36	28.68	41.01	5.97	30	1.00	412.22	411.96	414.51	414.44	420.29	420.29	21
122 TO 121	0.140	6.700	0.70	4.52	5.0	8.25	0.10	4.52	5.0	8.25	27.72	37.07	7.62	30	0.82	412.75	412.32	414.52	414.03	420.63	420.29	22

Notes: IDF File = RDU-Rainfall Intensity.idf, Return Period = 10-yrs. Project File: PRESERVE AT JONES DAIRY CENTRAL - STORM DRAINAGE SYSTEM 0100.sws

Storm Sewer Tabulation

Project Name: Enter Project Name...

Stormwater Studio 2024 v 3.0.0.33

01-19-2024

Line ID	Length (ft)		Drng Area (ac)		Rational (C)	C x A		Tc (min)		Intensity (in/hr)	Total Q (cfs)	Capacity (cfs)	Velocity (ft/s)	Line		Invert Elev (ft)		HGL Elev (ft)		Surface Elev (ft)		Line No
	Incr	Total	Incr	Total		Inlet	Syst	Incr	Total					Size (in)	Slope (%)	Up	Dn	Up	Dn	Up	Dn	
123 TO 122	0.200	6.460	0.14	4.36	0.70	0.14	4.36	5.0	8.08	6.17	26.88	41.09	7.82	30	1.00	413.78	412.85	415.51	414.43	421.15	420.63	23
124 TO 123	0.170	3.750	0.12	2.55	0.70	0.12	2.55	5.0	7.89	6.22	15.86	22.60	7.03	24	1.00	415.15	414.28	416.56	415.57	422.20	421.15	24
125 TO 124	0.110	3.580	0.08	2.43	0.70	0.08	2.43	5.0	7.74	6.25	15.21	22.64	6.04	24	1.00	415.93	415.25	417.31	416.89	423.02	422.20	25
126 TO 125	0.190	1.390	0.13	0.97	0.70	0.13	0.97	5.0	5.95	6.74	6.56	12.84	7.90	15	3.95	420.27	416.68	421.29	417.35	424.12	423.02	26
127 TO 126	0.230	1.200	0.16	0.84	0.70	0.16	0.84	5.0	5.55	6.86	5.76	6.96	5.39	15	1.16	422.15	420.37	423.11	421.46	426.00	424.12	27
128 TO 127	0.330	0.670	0.23	0.47	0.70	0.23	0.47	5.0	5.10	7.00	3.28	6.95	3.56	15	1.16	423.99	422.25	424.72	423.50	428.01	426.00	28
129 TO 128	0.340	0.340	0.24	0.24	0.70	0.24	0.24	5.0	5.00	7.04	1.67	6.46	2.41	15	1.00	424.36	424.09	424.94	424.97	428.11	428.01	29
130 TO 127	0.300	0.300	0.21	0.21	0.70	0.21	0.21	5.0	5.00	7.04	1.48	6.42	1.61	15	0.99	422.81	422.55	423.58	423.59	426.06	426.00	30
131 TO 125	0.590	2.080	0.41	1.38	0.70	0.41	1.38	5.0	7.66	6.28	8.67	10.42	6.21	18	0.98	419.67	419.35	420.79	420.44	423.24	423.02	31
132 TO 131	0.330	1.490	0.21	0.97	0.65	0.21	0.97	5.0	7.18	6.40	6.20	7.45	4.01	18	0.50	420.45	419.77	421.56	421.17	425.70	423.24	32
133 TO 132	0.210	1.160	0.14	0.75	0.65	0.14	0.75	5.0	6.91	6.47	4.88	4.60	4.22	15	0.51	421.05	420.70	422.17	421.82	424.30	425.70	33
134 TO 133	0.410	0.950	0.27	0.62	0.65	0.27	0.62	5.0	6.17	6.68	4.12	5.54	4.91	15	0.74	422.75	421.15	423.56	421.95	426.30	424.30	34
135 TO 134	0.540	0.540	0.35	0.35	0.65	0.35	0.35	5.0	5.00	7.04	2.47	4.57	4.00	15	0.50	424.19	422.85	424.82	423.48	427.44	426.30	35
136 TO 123	0.660	0.660	0.46	0.46	0.70	0.46	0.46	5.0	5.00	7.04	3.25	6.46	4.64	15	1.00	417.40	417.14	418.12	417.81	421.15	421.15	36
137 TO 123	0.500	1.850	0.33	1.20	0.65	0.33	1.20	5.0	6.05	6.71	8.07	20.94	7.70	18	3.97	417.00	414.78	418.08	415.51	420.60	421.15	37
138 TO 137	0.700	1.350	0.46	0.88	0.65	0.46	0.88	5.0	5.56	6.86	6.02	7.50	6.26	15	1.35	420.05	417.35	421.03	418.21	423.40	420.60	38
139 TO 138	0.650	0.650	0.42	0.42	0.65	0.42	0.42	5.0	5.00	7.04	2.97	7.36	3.46	15	1.30	422.85	420.37	423.54	421.45	426.10	423.40	39
140 TO 122	0.100	0.100	0.07	0.07	0.70	0.07	0.07	5.0	5.00	7.04	0.49	6.47	2.63	15	1.00	416.88	416.62	417.16	416.87	420.63	426.00	40
141 TO 120	0.360	1.360	0.25	0.95	0.70	0.25	0.95	5.0	5.57	6.86	6.53	18.19	7.08	18	3.00	418.56	414.52	419.54	415.18	422.11	420.29	41
142 TO 141	0.280	0.750	0.20	0.53	0.70	0.20	0.53	5.0	5.09	7.01	3.68	6.45	4.26	15	1.00	420.46	418.91	421.23	419.82	424.57	422.11	42
143 TO 142	0.470	0.470	0.33	0.33	0.70	0.33	0.33	5.0	5.00	7.04	2.31	6.46	4.13	15	1.00	420.82	420.56	421.43	421.12	424.57	424.57	43
144 TO 141	0.250	0.250	0.18	0.18	0.70	0.18	0.18	5.0	5.00	7.04	1.23	6.51	1.32	15	1.02	419.18	418.91	419.96	419.96	422.20	422.11	44

Storm Sewer Tabulation

Project Name: Enter Project Name...

Stormwater Studio 2024 v 3.0.0.33

01-19-2024

Line ID	Length (ft)	Drng Area		Rational	C x A		Tc		Intensity (in/hr)	Total Q (cfs)	Capacity (cfs)	Velocity (ft/s)	Line		Invert Elev		HGL Elev		Surface Elev		Line No
		Incr (ac)	Total (ac)		Incr	Total	Inlet (min)	Syst (min)					Size (in)	Slope (%)	Up (ft)	Dn (ft)	Up (ft)	Dn (ft)	Up (ft)	Dn (ft)	
145 to 117	29.82	0.110	1.360	0.70	0.08	0.89	5.0	5.60	6.85	6.09	14.43	7.54	15	5.00	415.98	414.49	416.97	415.15	422.16	422.30	45
146 to 145	67.27	0.730	1.250	0.65	0.47	0.81	5.0	5.41	6.91	5.61	6.44	5.72	15	1.00	416.75	416.08	417.70	417.00	420.10	422.16	46
147 to 146	150.00	0.520	0.520	0.65	0.34	0.34	5.0	5.00	7.04	2.38	8.90	2.99	15	1.90	419.85	417.00	420.47	418.12	423.10	420.10	47
148 TO 114	26.00	0.370	0.370	0.70	0.26	0.26	5.0	5.00	7.04	1.82	6.45	3.83	15	1.00	415.15	414.89	415.69	415.38	419.05	419.05	48
149 TO 107	34.00	0.670	0.670	0.70	0.47	0.47	5.0	5.00	7.04	3.30	6.46	3.55	15	1.00	400.47	400.13	401.23	401.25	404.22	404.22	49
150 TO 103	34.01	0.390	0.390	0.70	0.27	0.27	5.0	5.00	7.04	1.92	6.45	3.94	15	1.00	395.75	395.41	396.30	395.91	398.55	398.55	50
151 TO 102	127.47	0.190	13.970	0.70	0.13	7.77	5.0	6.66	6.54	50.77	71.29	5.49	42	0.50	391.09	390.45	394.14	393.92	398.62	399.63	51
152 TO 151	116.44	0.040	13.490	0.80	0.03	7.43	5.0	6.41	6.61	49.10	47.07	7.56	36	0.50	392.17	391.59	394.76	394.18	399.75	398.62	52
153 TO 152	70.65	0.220	10.380	0.70	0.15	5.56	5.0	6.24	6.66	36.97	46.94	5.34	36	0.50	392.62	392.27	395.38	395.22	400.98	399.75	53
154 TO 153	100.00	0.350	9.870	0.70	0.25	5.20	5.0	6.01	6.72	34.94	47.16	5.55	36	0.50	393.22	392.72	395.57	395.41	402.62	400.98	54
155 TO 154	155.00	0.090	9.520	0.80	0.07	4.95	5.0	5.66	6.83	33.82	47.31	6.71	36	0.50	394.10	393.32	395.96	395.53	405.17	402.62	55
156 TO 155	155.00	0.350	0.620	0.70	0.25	0.43	5.0	5.16	6.98	3.03	6.46	4.69	15	1.00	402.48	400.93	403.18	401.54	407.72	405.17	56
157 TO 156	39.30	0.270	0.270	0.70	0.19	0.19	5.0	5.00	7.04	1.33	6.43	3.53	15	0.99	404.45	404.06	404.91	404.47	408.20	407.72	57
158 TO 155	139.32	8.600	8.600	0.50	4.30	4.30	5.0	5.00	7.04	30.25	29.07	6.72	30	0.50	395.30	394.60	397.46	396.76	398.50	405.17	58
159 TO 155	26.00	0.210	0.210	0.70	0.15	0.15	5.0	5.00	7.04	1.03	6.46	3.25	15	1.00	401.19	400.93	401.60	401.29	405.17	405.17	59
160 TO 153	26.00	0.290	0.290	0.70	0.20	0.20	5.0	5.00	7.04	1.43	6.45	3.58	15	1.00	398.44	398.18	398.92	398.61	400.98	400.98	60
161 TO 152	27.24	3.070	3.070	0.60	1.84	1.84	5.0	5.00	7.04	12.96	30.71	10.23	18	8.55	396.00	393.67	397.35	394.51	399.50	399.75	61
163 TO 151	26.00	0.290	0.290	0.70	0.20	0.20	5.0	5.00	7.04	1.43	6.46	3.58	15	1.00	394.87	394.61	395.35	395.04	398.62	398.62	62
163 TO 101	97.33	0.170	26.076	0.70	0.12	17.05	5.0	10.04	5.73	97.76	101.92	9.06	48	0.50	390.17	389.68	393.33	392.93	400.64	399.63	63
164 TO 163	34.00	0.330	25.906	0.70	0.23	16.93	5.0	9.98	5.75	97.30	101.58	8.52	48	0.50	390.44	390.27	393.83	393.71	400.64	400.64	64
165 TO 164	21.60	0.340	25.576	0.60	0.20	16.70	5.0	9.94	5.76	96.11	102.51	9.21	48	0.51	390.65	390.54	393.74	393.64	399.00	400.64	65
166 TO 165	132.24	0.001	25.236	0.60	0.00	16.49	5.0	9.69	5.81	95.79	101.48	8.64	48	0.50	391.41	390.75	394.61	394.16	401.00	399.00	66

Notes: IDF File = RDU-Rainfall Intensity.idf, Return Period = 10-yrs. Project File: PRESERVE AT JONES DAIRY CENTRAL - STORM DRAINAGE SYSTEM 0100.sws

Storm Sewer Tabulation

Project Name: Enter Project Name...

Stormwater Studio 2024 v 3.0.0.33

01-19-2024

Line ID	Length (ft)		Drng Area (ac)		Rational (C)	C x A		Tc (min)		Intensity (in/hr)	Total Q (cfs)	Capacity (cfs)	Velocity (ft/s)	Line		Invert Elev (ft)		HGL Elev (ft)		Surface Elev (ft)		Line No
	Incr	Total	Incr	Total		Inlet	Syst	Incr	Total					Inlet	Syst	Incr	Total	Size (in)	Slope (%)	Up	Dn	
167 TO 166	1.850	25.235	0.55	16.49	5.0	9.57	1.02	16.49	5.0	9.57	96.20	101.67	8.54	48	0.50	391.83	391.51	395.14	394.93	400.00	401.00	67
168 TO 167	4.540	23.385	0.55	15.48	5.0	9.42	2.50	15.48	5.0	9.42	90.76	101.02	8.28	48	0.49	392.32	391.93	395.49	395.28	400.50	400.00	68
169 TO 168	0.010	18.845	0.75	12.98	5.0	8.84	0.01	12.98	5.0	8.84	77.79	101.50	8.94	48	0.50	393.93	392.42	396.55	395.03	406.00	400.50	69
170 TO 169	0.350	18.835	0.65	12.97	5.0	8.60	0.23	12.97	5.0	8.60	78.45	101.73	8.19	48	0.50	394.65	394.03	397.29	397.15	405.34	406.00	70
171 TO 170	0.001	18.485	0.75	12.74	5.0	8.50	0.00	12.74	5.0	8.50	77.37	102.07	7.53	48	0.50	395.01	394.75	397.96	397.91	405.87	405.34	71
172 TO 171	0.400	6.301	0.75	4.33	5.0	7.63	0.30	4.33	5.0	7.63	27.20	47.48	4.37	36	0.51	396.34	396.01	398.68	398.63	404.91	405.87	72
173 TO 172	0.340	5.601	0.75	3.85	5.0	7.32	0.26	3.85	5.0	7.32	24.49	29.04	6.63	30	0.50	397.45	396.84	399.21	398.60	403.73	404.91	73
174 TO 173	0.340	4.831	0.75	3.34	5.0	7.10	0.26	3.34	5.0	7.10	21.42	28.96	5.88	30	0.50	397.98	397.55	399.61	399.43	402.68	403.73	74
175 TO 174	0.360	3.901	0.75	2.73	5.0	6.93	0.27	2.73	5.0	6.93	17.63	28.97	5.06	30	0.50	398.38	398.08	399.94	399.89	403.41	402.68	75
176 TO 175	0.410	3.541	0.75	2.46	5.0	6.56	0.31	2.46	5.0	6.56	16.14	16.00	5.81	24	0.50	399.53	398.88	401.18	400.54	404.81	403.41	76
177 TO 176	0.001	2.341	0.75	1.68	5.0	6.06	0.00	1.68	5.0	6.06	11.24	16.62	4.44	24	0.54	400.53	399.62	401.83	401.50	406.09	404.81	77
178 TO 177	0.170	0.170	0.75	0.13	5.0	5.00	0.13	0.13	5.0	5.00	0.90	14.47	1.92	15	5.02	402.40	401.37	402.78	402.23	406.82	406.09	78
179 TO 177	0.540	2.170	0.75	1.55	5.0	5.94	0.41	1.55	5.0	5.94	10.44	15.78	5.36	24	0.49	400.81	400.63	402.00	401.82	405.92	406.09	79
180 TO 179	0.470	1.390	0.75	0.99	5.0	5.60	0.35	0.99	5.0	5.60	6.75	12.86	6.24	18	1.50	403.58	401.33	404.57	402.13	408.24	405.92	80
181 TO 180	0.470	0.700	0.75	0.50	5.0	5.27	0.35	0.50	5.0	5.27	3.49	10.34	5.90	15	2.57	407.73	403.83	408.48	404.35	411.94	408.24	81
182 TO 181	0.230	0.230	0.65	0.15	5.0	5.00	0.15	0.15	5.0	5.00	1.05	6.46	3.33	15	1.00	408.45	407.83	408.86	408.18	411.70	411.94	82
188 TO 180	0.220	0.220	0.60	0.13	5.0	5.00	0.13	0.13	5.0	5.00	0.93	6.46	2.06	15	1.00	404.89	404.27	405.28	405.01	408.14	408.24	83
187 TO 179	0.240	0.240	0.65	0.16	5.0	5.00	0.16	0.16	5.0	5.00	1.10	6.46	1.49	15	1.00	401.78	401.56	402.41	402.42	405.50	405.92	84
186 TO 176	0.790	0.790	0.60	0.47	5.0	5.00	0.47	0.47	5.0	5.00	3.33	14.85	4.76	18	2.00	400.81	400.37	401.51	400.94	403.06	404.81	85
185 TO 174	0.590	0.590	0.60	0.35	5.0	5.00	0.35	0.35	5.0	5.00	2.49	4.57	2.85	15	0.50	399.34	399.23	400.14	400.11	401.83	402.68	86
184 TO 173	0.430	0.430	0.60	0.26	5.0	5.00	0.26	0.26	5.0	5.00	1.82	6.44	3.92	15	0.99	400.75	400.13	401.29	400.60	404.00	403.73	87
183 TO 172	0.300	0.300	0.60	0.18	5.0	5.00	0.18	0.18	5.0	5.00	1.27	9.13	2.27	15	2.00	398.68	398.09	399.13	398.98	404.04	404.91	88

Storm Sewer Tabulation

Stormwater Studio 2024 v 3.0.0.33

Project Name: Enter Project Name...

01-19-2024

Line ID	Length		Drng Area		Rational	C x A		Tc		Intensity	Total Q	Capacity	Velocity	Line		Invert Elev		HGL Elev		Surface Elev		Line No
	(ft)	(ac)	Incr (ac)	Total (ac)		Incr	Total	Inlet (min)	Syst (min)					Size (in)	Slope (%)	Up (ft)	Dn (ft)	Up (ft)	Dn (ft)	Up (ft)	Dn (ft)	
189 TO 171	66.79	0.470	0.470	12.183	0.75	0.35	8.41	5.0	8.42	6.09	51.25	94.40	10.05	36	2.00	397.35	396.01	399.63	397.86	406.69	405.87	89
190 TO 189	65.12	0.010	0.010	10.963	0.75	0.01	7.57	5.0	8.31	6.12	46.33	66.63	8.81	36	1.00	398.10	397.45	400.27	399.47	407.65	406.69	90
191 TO 190	80.30	0.001	0.001	10.893	0.80	0.00	7.53	5.0	8.17	6.15	46.30	66.57	8.86	36	1.00	399.00	398.20	401.17	400.20	408.73	407.65	91
192 TO 191	183.08	0.400	0.400	5.321	0.75	0.30	3.71	5.0	6.57	6.56	24.35	50.26	6.07	30	1.50	402.25	399.50	403.90	401.88	411.12	408.73	92
193 TO 192	131.67	0.400	0.400	4.491	0.75	0.30	3.13	5.0	6.37	6.62	20.74	62.62	8.38	30	2.33	405.42	402.35	406.94	403.44	412.90	411.12	93
194 TO 193	131.67	0.630	0.630	3.761	0.75	0.47	2.62	5.0	6.12	6.69	17.54	25.78	7.67	24	1.30	407.63	405.92	409.11	407.19	414.68	412.90	94
195 TO 194	144.67	0.001	0.001	2.701	0.75	0.00	1.87	5.0	5.82	6.78	12.69	25.78	5.11	24	1.30	409.61	407.73	410.87	409.61	416.78	414.68	95
196 TO 195	42.59	0.340	0.340	2.700	0.70	0.24	1.87	5.0	5.77	6.80	12.71	50.46	8.24	24	4.98	411.83	409.71	413.09	410.54	417.09	416.78	96
197 TO 196	34.00	1.240	1.240	1.980	0.70	0.87	1.39	5.0	5.70	6.81	9.45	14.85	7.05	18	2.00	413.01	412.33	414.18	413.31	417.09	417.09	97
198 TO 197	228.85	0.740	0.740	0.740	0.70	0.52	0.52	5.0	5.00	7.04	3.64	6.46	3.98	15	1.00	415.88	413.59	416.64	414.64	421.22	417.09	98
199 TO 196	18.00	0.380	0.380	0.380	0.65	0.25	0.25	5.0	5.00	7.04	1.74	6.46	1.75	15	1.00	412.76	412.58	413.62	413.63	416.01	417.09	99
200 TO 194	55.50	0.060	0.060	0.060	0.60	0.04	0.04	5.0	5.00	7.04	0.25	6.43	2.21	15	0.99	411.09	410.54	411.29	410.71	414.34	414.68	100
201 TO 194	29.50	0.370	0.370	0.370	0.65	0.24	0.24	5.0	5.00	7.04	1.69	6.40	3.77	15	0.98	410.49	410.20	411.01	410.67	413.74	414.68	101
202 TO 193	29.50	0.280	0.280	0.280	0.65	0.18	0.18	5.0	5.00	7.04	1.28	6.40	3.46	15	0.98	408.69	408.40	409.14	408.80	411.94	412.90	102
203 TO 193	55.50	0.050	0.050	0.050	0.60	0.03	0.03	5.0	5.00	7.04	0.21	6.43	2.10	15	0.99	409.93	409.38	410.11	409.54	413.18	412.90	103
204 TO 192	29.50	0.370	0.370	0.370	0.65	0.24	0.24	5.0	5.00	7.04	1.69	6.40	3.77	15	0.98	406.88	406.59	407.40	407.06	410.13	411.12	104
205 TO 192	55.50	0.060	0.060	0.060	0.60	0.04	0.04	5.0	5.00	7.04	0.25	6.43	2.21	15	0.99	407.75	407.20	407.95	407.37	411.00	411.12	105
206 TO 191	72.74	0.060	0.060	0.060	0.60	0.04	0.04	5.0	5.00	7.04	0.25	6.47	2.23	15	1.00	405.85	405.12	406.05	405.29	409.10	408.73	106
207 TO 191	45.19	0.660	0.660	5.511	0.70	0.46	3.79	5.0	8.08	6.17	23.35	40.92	7.29	30	1.00	403.24	402.79	404.86	404.29	408.16	408.73	107
208 TO 207	61.19	0.410	0.410	4.851	0.75	0.31	3.32	5.0	7.96	6.20	20.61	22.58	7.75	24	1.00	404.35	403.74	405.96	405.29	409.30	408.16	108
209 TO 208	133.33	0.220	0.220	3.321	0.75	0.17	2.34	5.0	7.66	6.27	14.70	22.59	6.89	24	1.00	406.30	404.97	407.66	406.19	415.20	409.30	109
210 TO 209	135.67	0.001	0.001	2.961	0.70	0.00	2.09	5.0	7.44	6.33	13.22	34.15	7.75	24	2.28	409.49	406.40	410.78	407.32	416.28	415.20	110

Notes: IDF File = RDU-Rainfall Intensity.idf, Return Period = 10-yrs.

Project File: PRESERVE AT JONES DAIRY CENTRAL - STORM DRAINAGE SYSTEM 0100.sws

Storm Sewer Tabulation

Stormwater Studio 2024 v 3.0.0.33

Project Name: Enter Project Name...

01-19-2024

Line ID	Length (ft)	Drng Area		Rational	C x A		Tc		Intensity (in/hr)	Total Q (cfs)	Capacity (cfs)	Velocity (ft/s)	Line		Invert Elev		HGL Elev		Surface Elev		Line No
		Incr (ac)	Total (ac)		Incr	Total	Inlet (min)	Syst (min)					Size (in)	Slope (%)	Up (ft)	Dn (ft)	Up (ft)	Dn (ft)	Up (ft)	Dn (ft)	
211 TO 210	36.06	0.380	0.620	0.75	0.29	0.44	5.0	5.26	6.95	3.07	6.45	3.63	15	1.00	410.60	410.24	411.30	411.23	415.56	416.28	111
212 TO 211	62.00	0.240	0.240	0.65	0.16	0.16	5.0	5.00	7.04	1.10	6.46	3.39	15	1.00	411.32	410.70	411.74	411.06	414.57	415.56	112
213 TO 210	116.24	0.470	2.340	0.75	0.35	1.65	5.0	7.16	6.40	10.54	22.59	6.14	24	1.00	411.95	410.79	413.10	411.80	417.70	416.28	113
213A TO 213	152.00	0.470	1.620	0.75	0.35	1.13	5.0	6.77	6.51	7.36	10.50	5.96	18	1.00	413.97	412.45	415.01	413.40	419.60	417.70	114
214 TO 213A	152.00	0.320	0.890	0.75	0.24	0.62	5.0	6.40	6.61	4.11	14.36	5.57	18	1.87	417.13	414.29	417.90	414.86	421.50	419.60	115
215 TO 214	103.43	0.270	0.270	0.75	0.20	0.20	5.0	5.00	7.04	1.42	9.25	2.53	15	2.05	419.50	417.38	419.98	418.16	423.25	421.50	116
216 TO 214	65.75	0.060	0.300	0.60	0.04	0.18	5.0	6.13	6.69	1.20	6.47	2.29	15	1.00	418.04	417.38	418.48	418.18	421.06	421.50	117
217 TO 216	46.25	0.180	0.240	0.60	0.11	0.14	5.0	5.93	6.75	0.97	6.44	3.23	15	0.99	418.60	418.14	418.99	418.48	421.99	421.06	118
218 TO 217	142.00	0.060	0.060	0.60	0.04	0.04	5.0	5.00	7.04	0.25	6.46	1.34	15	1.00	420.12	418.70	420.32	419.12	423.37	421.99	119
219 TO 213	62.00	0.250	0.250	0.65	0.16	0.16	5.0	5.00	7.04	1.14	6.46	2.17	15	1.00	413.32	412.70	413.75	413.57	416.57	417.70	120
220 TO 209	58.00	0.140	0.140	0.65	0.09	0.09	5.0	5.00	7.04	0.64	6.46	2.89	15	1.00	410.95	410.37	411.27	410.64	414.20	415.20	121
221 TO 208	61.07	1.120	1.120	0.60	0.67	0.67	5.0	5.00	7.04	4.73	9.64	6.15	15	2.23	407.33	405.97	408.20	406.64	410.50	409.30	122
222 TO 190	51.50	0.060	0.060	0.60	0.04	0.04	5.0	5.00	7.04	0.25	6.43	2.21	15	0.99	404.67	404.16	404.87	404.33	407.92	407.65	123
223 TO 189	29.50	0.750	0.750	0.65	0.49	0.49	5.0	5.00	7.04	3.43	6.51	4.74	15	1.02	402.59	402.29	403.33	402.98	405.84	406.69	124
314 TO 112	78.56	0.300	0.300	0.70	0.21	0.21	5.0	5.00	7.04	1.48	6.48	3.72	15	1.01	413.48	412.69	413.97	413.11	417.23	418.20	125
213B TO 213A	62.00	0.260	0.260	0.60	0.16	0.16	5.0	5.00	7.04	1.10	6.46	3.39	15	1.00	415.22	414.60	415.64	414.96	418.47	419.60	126

Ac. t be update per revised DA

was this pipe to be removed, per David it was to be removed

Storm Sewer Tabulation

Project Name: Enter Project Name...

Stormwater Studio 2023 v 3.0.0.31

05-03-2023

Line ID	Length (ft)		Drng Area (ac)		Rational (C)	C x A		Tc (min)		Intensity (in/hr)	Total Q (cfs)	Capacity (cfs)	Velocity (ft/s)	Line		Invert Elev (ft)		HGL Elev (ft)		Surface Elev (ft)		Line No
	Incr	Total	Incr	Total		Inlet	Syst	Incr	Total					Size (in)	Slope (%)	Up	Dn	Up	Dn	Up	Dn	
301 TO 300	0.120	26.874	0.70	17.07	5.0	9.33	0.08	17.07	5.0	9.33	100.42	143.64	10.67	48	1.00	393.58	392.00	396.54	394.67	411.53	409.00	1
318 TO 301	0.470	1.950	0.65	1.27	5.0	5.96	0.31	1.27	5.0	5.96	8.54	10.45	6.21	18	0.99	405.40	404.87	406.52	405.94	409.50	411.53	2
319 TO 318	0.770	1.480	0.65	0.96	5.0	5.56	0.50	0.96	5.0	5.56	6.60	10.50	4.68	18	1.00	407.00	405.50	407.98	406.84	411.00	409.50	3
320 TO 319	0.710	0.710	0.65	0.46	5.0	5.00	0.46	0.46	5.0	5.00	3.25	7.64	3.70	15	1.40	410.05	407.25	410.77	408.29	413.80	411.00	4
302 TO 301	0.030	22.024	0.70	13.77	5.0	9.16	0.02	13.77	5.0	9.16	81.55	143.65	9.79	48	1.00	395.96	394.75	398.63	397.14	413.22	411.53	5
303 TO 302	0.001	11.892	0.70	8.05	5.0	8.84	0.00	8.05	5.0	8.84	48.24	66.69	9.19	36	1.00	398.90	396.96	401.12	398.94	415.40	413.22	6
304 TO 303	0.060	10.151	0.70	6.92	5.0	8.67	0.04	6.92	5.0	8.67	41.73	66.69	7.20	36	1.00	400.00	399.00	402.06	401.65	414.57	415.40	7
305 TO 304	0.190	5.691	0.70	3.86	5.0	7.19	0.13	3.86	5.0	7.19	24.67	41.01	7.71	30	1.00	402.30	400.50	403.96	401.96	412.58	414.57	8
306 TO 305	0.030	3.500	0.70	2.39	5.0	6.94	0.02	2.39	5.0	6.94	15.47	22.62	7.02	24	1.00	404.00	402.80	405.39	404.07	413.40	412.58	9
307 TO 306	0.170	3.470	0.70	2.37	5.0	6.82	0.12	2.37	5.0	6.82	15.40	22.62	6.16	24	1.00	404.62	404.10	406.01	405.70	413.39	413.40	10
308 TO 307	0.210	3.300	0.70	2.25	5.0	6.78	0.15	2.25	5.0	6.78	14.66	32.10	7.16	24	2.01	405.24	404.72	406.60	405.87	413.39	413.39	11
309 TO 308	0.140	1.990	0.70	1.39	5.0	6.68	0.10	1.39	5.0	6.68	9.10	31.96	6.33	24	2.00	406.97	405.94	408.04	406.78	414.49	413.39	12
363 TO 309	0.150	0.150	0.70	0.11	5.0	5.00	0.11	0.11	5.0	5.00	0.74	6.45	2.97	15	1.00	410.95	410.62	411.29	410.92	414.70	414.49	13
310 TO 309	0.080	1.700	0.70	1.19	5.0	6.32	0.06	1.19	5.0	6.32	7.90	15.92	4.96	24	0.50	407.62	407.07	408.62	408.09	415.68	414.49	14
311 TO 310	0.130	1.620	0.70	1.13	5.0	6.07	0.09	1.13	5.0	6.71	7.60	15.96	4.63	24	0.50	408.09	407.72	409.07	408.82	416.43	415.68	15
312 TO 311	0.090	1.490	0.70	1.04	5.0	5.70	0.06	1.04	5.0	6.82	7.11	16.02	4.48	24	0.50	408.74	408.19	409.68	409.27	417.80	416.43	16
364 TO 312	0.260	0.860	0.70	0.60	5.0	5.11	0.18	0.60	5.0	7.00	4.21	6.46	5.22	15	1.00	415.42	413.44	416.24	414.18	419.61	417.80	17
365 TO 364	0.600	0.600	0.70	0.42	5.0	5.00	0.42	0.42	5.0	7.04	2.96	6.46	3.59	15	1.00	415.86	415.52	416.55	416.48	419.61	419.61	18
313 TO 312	0.540	0.540	0.70	0.38	5.0	5.00	0.38	0.38	5.0	7.04	2.66	10.50	4.15	18	1.00	409.68	409.34	410.30	409.90	417.80	417.80	19
360 TO 308	0.100	1.100	0.70	0.71	5.0	5.09	0.07	0.71	5.0	7.01	5.00	6.46	5.52	15	1.00	409.88	408.56	410.78	409.39	415.56	413.39	20
361 TO 360	0.430	0.430	0.70	0.30	5.0	5.00	0.30	0.30	5.0	7.04	2.12	6.46	4.04	15	1.00	411.81	411.55	412.39	412.08	415.56	415.56	21
362 TO 360	0.570	0.570	0.60	0.34	5.0	5.00	0.34	0.34	5.0	7.04	2.41	6.44	2.27	15	1.00	410.25	409.98	411.15	411.15	414.00	415.56	22

Storm Sewer Tabulation

Stormwater Studio 2023 v 3.0.0.31

Project Name: Enter Project Name...

05-03-2023

Line ID	Length (ft)	Drng Area		Rational	C x A		Tc		Intensity (in/hr)	Total Q (cfs)	Capacity (cfs)	Velocity (ft/s)	Line		Invert Elev		HGL Elev		Surface Elev		Line No
		Incr (ac)	Total (ac)		Incr	Total	Inlet (min)	Syst (min)					Size (in)	Slope (%)	Up (ft)	Dn (ft)	Up (ft)	Dn (ft)	Up (ft)	Dn (ft)	
356 TO 305	15.62	0.001	1.371	0.70	0.00	0.89	5.0	5.85	6.77	6.03	6.45	5.82	15	1.00	407.41	407.25	408.40	408.24	412.60	412.58	23
357 TO 356	43.93	0.840	1.370	0.65	0.55	0.89	5.0	5.73	6.81	6.06	6.46	5.87	15	1.00	407.95	407.51	408.94	408.49	411.80	412.60	24
358 TO 357	192.17	0.310	0.530	0.65	0.20	0.34	5.0	5.24	6.96	2.40	9.79	2.98	15	2.30	412.65	408.23	413.27	409.40	416.50	411.80	25
359 TO 358	70.25	0.220	0.220	0.65	0.14	0.14	5.0	5.00	7.04	1.01	9.12	2.15	15	1.99	414.15	412.75	414.55	413.48	417.90	416.50	26
355 TO 305	26.00	0.630	0.630	0.70	0.44	0.44	5.0	5.00	7.04	3.10	6.46	4.57	15	1.00	408.83	408.57	409.54	409.22	412.58	412.58	27
338 TO 304	52.19	0.370	4.400	0.70	0.26	3.02	5.0	8.62	6.04	18.24	59.32	10.19	24	6.88	404.59	401.00	406.10	401.90	413.24	414.57	28
339 TO 338	26.00	0.140	4.030	0.70	0.10	2.76	5.0	8.56	6.06	16.71	22.62	7.01	24	1.00	404.95	404.69	406.40	406.08	413.24	413.24	29
340 TO 339	126.16	0.320	3.890	0.70	0.22	2.66	5.0	8.29	6.12	16.28	22.60	6.31	24	1.00	406.31	405.05	407.74	406.71	415.23	413.24	30
341 TO 340	198.66	0.230	3.140	0.70	0.16	2.14	5.0	7.84	6.23	13.30	22.64	5.44	24	1.00	408.40	406.41	409.69	408.11	418.92	415.23	31
342 TO 341	226.14	0.180	2.910	0.70	0.13	1.97	5.0	7.33	6.36	12.56	22.61	6.59	24	1.00	410.76	408.50	412.02	409.59	422.62	418.92	32
343 TO 342	26.00	0.080	2.730	0.70	0.06	1.85	5.0	7.27	6.37	11.78	22.62	6.12	24	1.00	411.12	410.86	412.34	412.00	422.62	422.62	33
343A TO 343	72.59	0.120	2.650	0.70	0.08	1.79	5.0	7.10	6.42	11.51	22.68	5.39	24	1.01	411.95	411.22	413.15	412.61	423.40	422.62	34
344 TO 343	112.21	0.090	1.280	0.70	0.06	0.90	5.0	6.95	6.46	5.79	25.95	7.96	18	6.10	419.30	412.45	420.22	412.96	424.55	423.40	35
345 TO 344	86.80	0.130	1.000	0.70	0.09	0.70	5.0	6.74	6.52	4.56	8.66	5.91	15	1.80	421.11	419.55	421.97	420.23	425.48	424.55	36
346 TO 345	112.74	0.230	0.870	0.70	0.16	0.61	5.0	6.40	6.61	4.03	6.46	5.12	15	1.00	422.34	421.21	423.14	421.94	426.63	425.48	37
347 TO 346	200.00	0.170	0.550	0.70	0.12	0.39	5.0	5.74	6.81	2.62	6.46	3.34	15	1.00	424.44	422.44	425.09	423.40	428.64	426.63	38
348 TO 347	150.00	0.220	0.300	0.70	0.15	0.21	5.0	5.15	6.99	1.47	6.46	2.63	15	1.00	426.04	424.54	426.52	425.29	430.15	428.64	39
349 TO 348	26.00	0.080	0.080	0.70	0.06	0.06	5.0	5.00	7.04	0.39	6.46	1.33	15	1.00	426.40	426.14	426.68	426.69	430.15	430.15	40
354 TO 347	26.00	0.080	0.080	0.70	0.06	0.06	5.0	5.00	7.04	0.39	7.49	0.73	15	1.35	424.89	424.54	425.34	425.34	428.64	428.64	41
353 TO 346	26.00	0.090	0.090	0.70	0.06	0.06	5.0	5.00	7.04	0.44	8.40	0.56	15	1.69	422.88	422.44	423.50	423.50	426.63	426.63	42
351 TO 344	73.31	0.190	0.190	0.70	0.13	0.13	5.0	5.00	7.04	0.94	6.13	3.16	15	0.90	420.28	419.62	420.67	419.96	424.39	424.55	43
315 TO 343A	51.04	0.000	1.250	0.00	0.00	0.81	0.0	6.04	6.71	5.46	10.50	4.58	18	1.00	412.96	412.45	413.85	413.49	423.91	423.40	44

Notes: IDF File = RDU-Rainfall Intensity.idf, Return Period = 10-yrs.

Project File: PRESERVE AT JONES DAIRY CENTRAL - STORM DRAINAGE SYSTEM 0300.sws

Storm Sewer Tabulation

Project Name: Enter Project Name...

Stormwater Studio 2023 v 3.0.0.31

05-03-2023

Line ID	Length (ft)	Drng Area		Rational	C x A		Tc		Intensity (in/hr)	Total Q (cfs)	Capacity (cfs)	Velocity (ft/s)	Line		Invert Elev		HGL Elev		Surface Elev		Line No
		Incr (ac)	Total (ac)		Incr	Total	Inlet (min)	Syst (min)					Size (in)	Slope (%)	Up (ft)	Dn (ft)	Up (ft)	Dn (ft)	Up (ft)	Dn (ft)	
316 TO 315	204.81	0.550	1.250	0.65	0.36	0.81	5.0	5.48	6.88	5.59	10.51	5.46	18	1.00	415.11	413.06	416.01	413.85	419.11	423.91	45
317 TO 316	150.00	0.700	0.700	0.65	0.46	0.46	5.0	5.00	7.04	3.20	6.46	4.76	15	1.00	416.86	415.36	417.58	415.99	420.11	419.11	46
350 TO 340	26.00	0.430	0.430	0.70	0.30	0.30	5.0	5.00	7.04	2.12	6.47	4.04	15	1.00	411.48	411.22	412.06	411.75	415.23	415.23	47
333 TO 303	67.00	0.170	1.740	0.65	0.11	1.13	5.0	5.93	6.75	7.63	10.50	5.99	18	1.00	409.04	408.37	410.09	409.35	414.53	415.40	48
334 TO 333	100.00	0.370	1.570	0.65	0.24	1.02	5.0	5.67	6.82	6.96	10.50	5.82	18	1.00	410.14	409.14	411.15	410.06	414.53	414.53	49
335 TO 334	100.00	0.270	1.200	0.65	0.18	0.78	5.0	5.39	6.91	5.39	6.46	5.66	15	1.00	411.39	410.39	412.32	411.27	415.53	414.53	50
336 TO 335	60.09	0.170	0.930	0.65	0.11	0.60	5.0	5.21	6.97	4.21	6.46	4.34	15	1.00	412.09	411.49	412.91	412.57	416.32	415.53	51
337 TO 336	66.97	0.760	0.760	0.65	0.49	0.49	5.0	5.00	7.04	3.48	6.46	4.24	15	1.00	412.86	412.19	413.61	413.04	416.61	416.32	52
322 TO 302	59.02	0.130	9.882	0.70	0.09	5.55	5.0	6.58	6.56	36.39	41.00	8.75	30	1.00	401.21	400.62	403.23	402.56	413.37	413.22	53
323 TO 322	26.00	0.580	9.752	0.70	0.41	5.46	5.0	6.53	6.57	35.87	41.01	8.13	30	1.00	401.57	401.31	403.58	403.54	413.37	413.37	54
324 TO 323	170.39	0.390	9.172	0.70	0.27	5.05	5.0	6.23	6.66	33.64	41.01	8.61	30	1.00	403.37	401.67	405.31	403.45	415.13	413.37	55
325 TO 324	200.00	0.330	8.672	0.70	0.23	4.70	5.0	5.86	6.77	31.81	41.01	8.46	30	1.00	405.47	403.47	407.36	405.18	417.37	415.13	56
326 TO 325	178.00	0.001	8.112	0.70	0.00	4.31	5.0	5.53	6.87	29.58	41.01	8.21	30	1.00	407.35	405.57	409.17	407.21	419.02	417.37	57
327 TO 326	90.79	0.570	8.111	0.70	0.40	4.31	5.0	5.37	6.92	29.80	41.01	8.14	30	1.00	408.36	407.45	410.19	409.13	418.81	419.02	58
328 TO 327	34.00	0.920	7.541	0.65	0.60	3.91	5.0	5.30	6.94	27.12	41.01	6.91	30	1.00	408.80	408.46	410.54	410.48	418.81	418.81	59
329 TO 328	24.75	0.001	6.621	0.70	0.00	3.31	5.0	5.25	6.95	23.02	22.62	8.08	24	1.00	409.55	409.30	411.25	411.00	419.11	418.81	60
330 TO 329	125.00	6.620	6.620	0.50	3.31	3.31	5.0	5.00	7.04	23.29	22.62	8.13	24	1.00	410.90	409.65	412.62	411.35	415.40	419.11	61
332 TO 325	27.86	0.230	0.230	0.70	0.16	0.16	5.0	5.00	7.04	1.13	6.46	3.34	15	1.00	413.73	413.45	414.16	413.83	417.48	417.37	62
331 TO 324	27.86	0.110	0.110	0.70	0.08	0.08	5.0	5.00	7.04	0.54	6.46	2.70	15	1.00	411.49	411.21	411.78	411.47	415.24	415.13	63
321 TO 302	26.00	0.220	0.220	0.70	0.15	0.15	5.0	5.00	7.04	1.08	6.46	3.28	15	1.00	409.47	409.21	409.89	409.58	413.22	413.22	64
366 TO 301	31.12	0.180	2.780	0.70	0.13	1.95	5.0	6.64	6.54	12.74	22.72	6.33	24	1.01	402.76	402.45	404.03	403.63	411.43	411.53	65
367 TO 366	88.52	0.210	2.270	0.70	0.15	1.59	5.0	6.42	6.61	10.50	10.50	6.74	18	1.00	404.15	403.26	405.39	404.49	412.21	411.43	66

Notes: IDF File = RDU-Rainfall Intensity.idf, Return Period = 10-yrs. Project File = PRESERVE AT JONES DAIRY CENTRAL - STORM DRAINAGE SYSTEM 0300.sws

Storm Sewer Tabulation

Project Name: Enter Project Name...

Stormwater Studio 2023 v 3.0.0.31

05-03-2023

Line ID	Length (ft)	Drng Area (ac)		Rational (C)	C x A		Tc (min)		Intensity (in/hr)	Total Q (cfs)	Capacity (cfs)	Velocity (ft/s)	Line		Invert Elev (ft)		HGL Elev (ft)		Surface Elev (ft)		Line No
		Incr	Total		Incr	Total	Inlet	Syst					Incr	Total	Size (in)	Slope (%)	Up	Dn	Up	Dn	
368 TO 367	117.23	0.280	1.740	0.70	0.20	1.22	5.0	6.12	6.69	8.15	10.50	6.17	18	1.00	405.32	404.15	406.41	405.16	414.68	412.21	67
368 TO 368	328.78	0.660	1.210	0.70	0.46	0.85	5.0	5.22	6.96	5.90	10.50	4.35	18	1.00	408.71	405.42	409.64	406.76	413.07	414.68	68
370 TO 369	73.25	0.270	0.270	0.70	0.19	0.19	5.0	5.00	7.04	1.33	9.48	2.27	15	2.16	410.64	409.06	411.10	410.02	414.39	413.07	69
374 TO 369	26.00	0.280	0.280	0.70	0.20	0.20	5.0	5.00	7.04	1.38	6.46	1.68	15	1.00	409.32	409.06	410.01	410.02	413.07	413.07	70
383 TO 368	26.00	0.250	0.250	0.70	0.18	0.18	5.0	5.00	7.04	1.23	6.47	3.40	15	1.00	410.93	410.67	411.37	411.07	414.68	414.68	71
372 TO 367	26.00	0.320	0.320	0.70	0.22	0.22	5.0	5.00	7.04	1.58	6.45	3.68	15	1.00	408.46	408.20	408.96	408.65	412.21	412.21	72
371 TO 366	26.00	0.330	0.330	0.70	0.23	0.23	5.0	5.00	7.04	1.63	6.45	3.70	15	1.00	407.68	407.42	408.19	407.88	411.43	411.43	73

Notes: IDF File = RDU-Rainfall Intensity.idf, Return Period = 10-yls.

Project File: PRESERVE AT JONES DAIRY CENTRAL - STORM DRAINAGE SYSTEM 0300.sws

Storm Sewer Tabulation

Project Name: Enter Project Name...

Stormwater Studio 2022 v 3.0.0.29

12-12-2022

Line ID	Length (ft)	Drng Area (ac)		Rational (C)	C x A		Tc (min)		Intensity (in/hr)	Total Q (cfs)	Capacity (cfs)	Velocity (ft/s)	Line		Invert Elev (ft)		HGL Elev (ft)		Surface Elev (ft)		Line No
		Incr	Total		Incr	Total	Inlet	Syst					Incr	Total	Incr	Total	Incr	Total	Incr	Total	
401 TO 400	37.42	0.001	19.141	0.75	0.00	8.12	5.0	15.08	4.87	39.54	23.68	12.62	24	1.10	405.35	404.94	408.00	406.89	409.10	409.00	1
402 TO 401	17.46	0.100	19.140	0.90	0.09	8.11	5.0	15.06	4.88	39.56	16.24	12.59	24	0.52	405.94	405.85	408.54	408.00	409.25	409.10	2
403 TO 402	17.34	0.270	1.840	0.75	0.20	1.14	5.0	5.26	6.95	7.96	7.56	4.50	18	0.52	406.13	406.04	410.79	410.69	408.98	409.25	3
404 TO 403	34.00	0.700	1.570	0.60	0.42	0.94	5.0	5.14	6.99	6.59	7.43	3.73	18	0.50	406.40	406.23	411.02	410.88	408.98	408.98	4
405 TO 404	71.28	0.870	0.870	0.60	0.52	0.52	5.0	5.00	7.04	3.67	19.67	2.08	18	3.51	409.00	406.50	411.25	411.17	412.00	408.98	5
406 TO 402	58.58	17.200	17.200	0.40	6.88	6.88	15.0	15.00	4.88	33.60	47.28	10.70	24	4.37	408.00	405.44	410.52	409.22	412.00	409.25	6

Notes: IDF File = RDU-Rainfall Intensity.idf, Return Period = 10-yls.

Project File: PRESERVE AT JONES DAIRY CENTRAL - STORM DRAINAGE SYSTEM 0400.sws

APPENDIX C – STORM SEWER HGL CALCULATIONS

10-YEAR HGL

Line 1 - 101 TO 100

Stormwater Studio 2024 v 3.0.0.33

Project Name: Enter Project Name...

01-19-2024

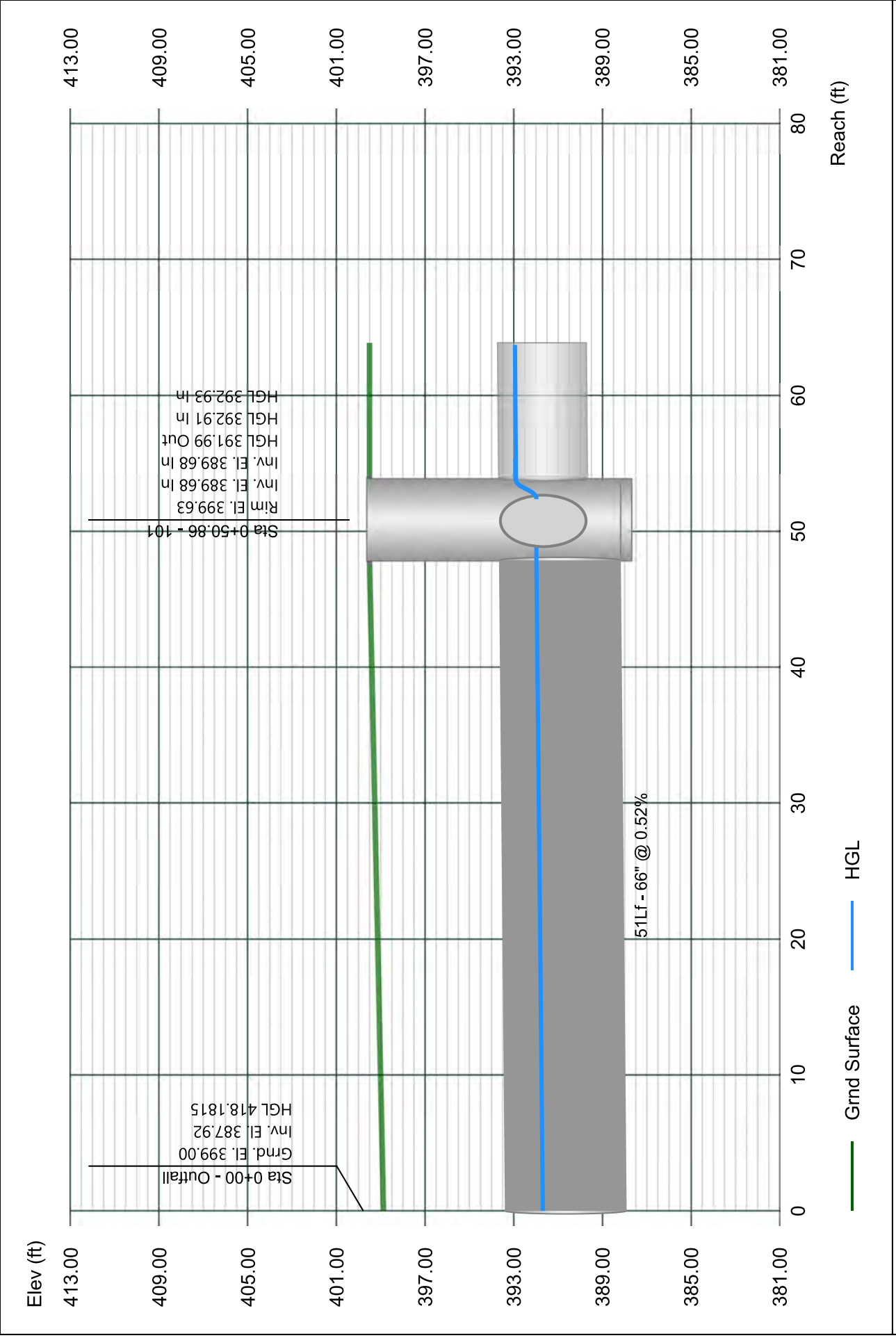

Line 2 - 102 TO 101

Stormwater Studio 2024 v 3.0.0.33

Project Name: Enter Project Name...

01-19-2024

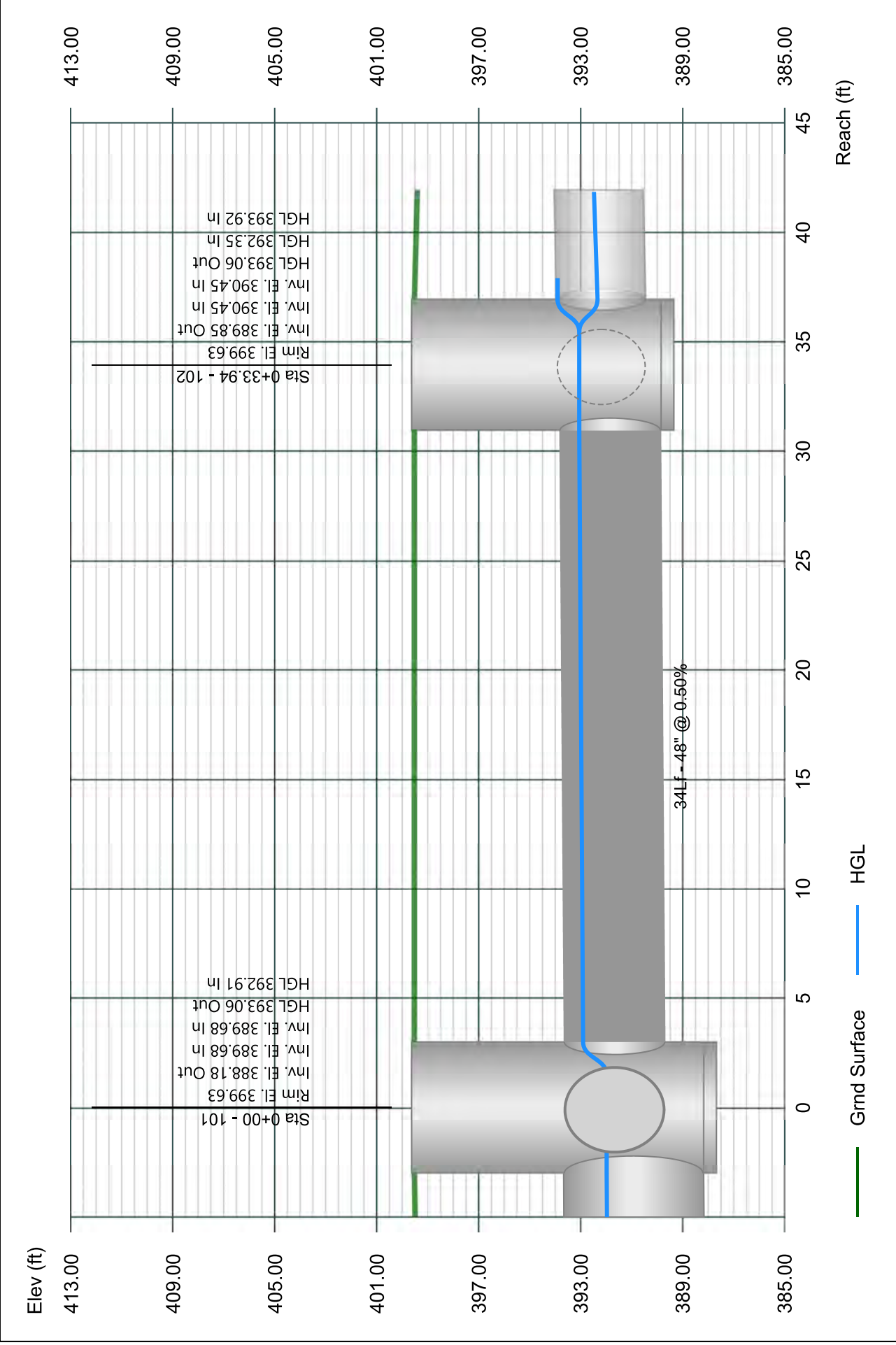

Line 3 - 103 TO 102

Stormwater Studio 2024 v 3.0.0.33

Project Name: Enter Project Name...

01-19-2024

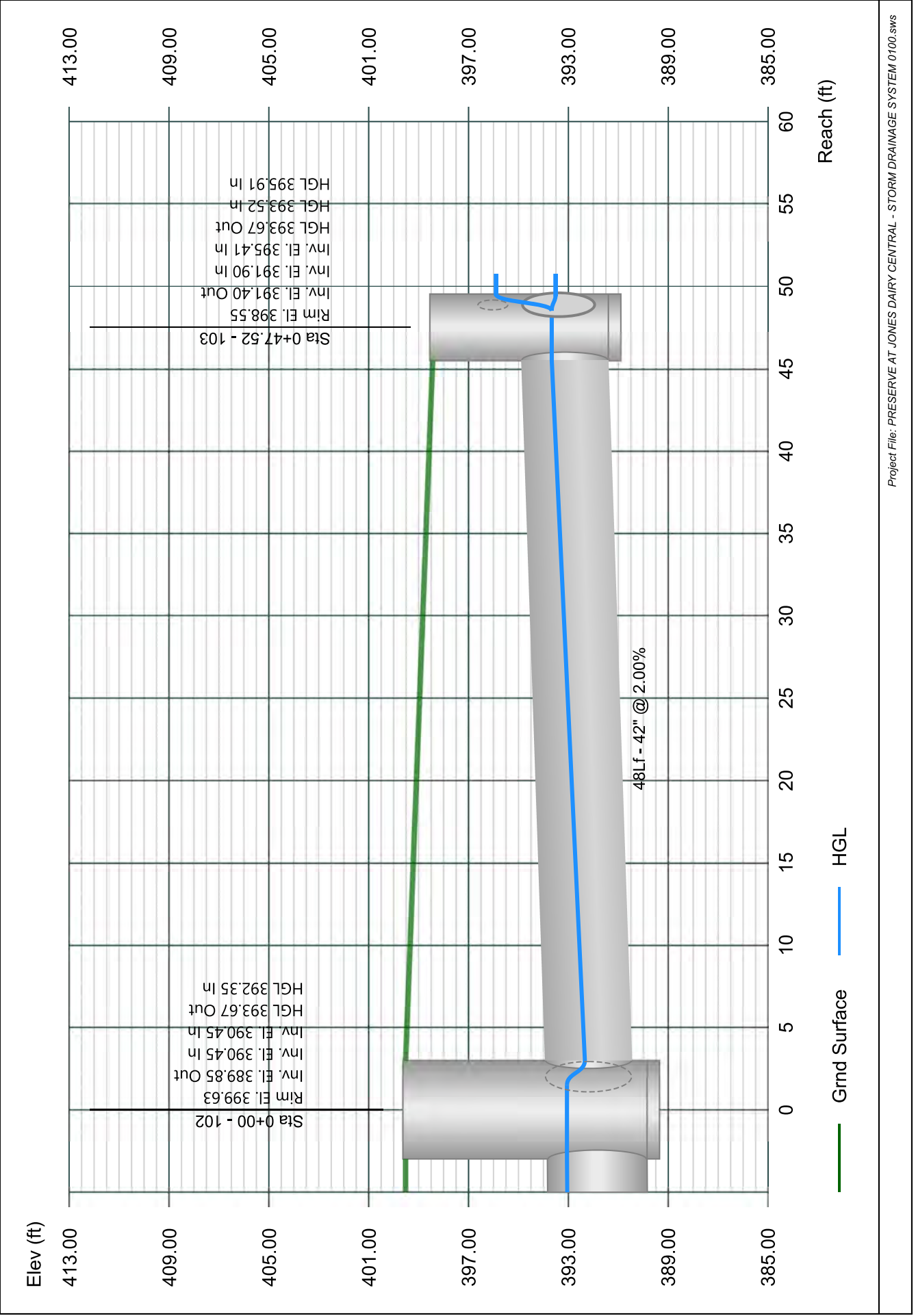

Line 4 - 104 TO 103

Stormwater Studio 2024 v 3.0.0.33

Project Name: Enter Project Name...

01-19-2024

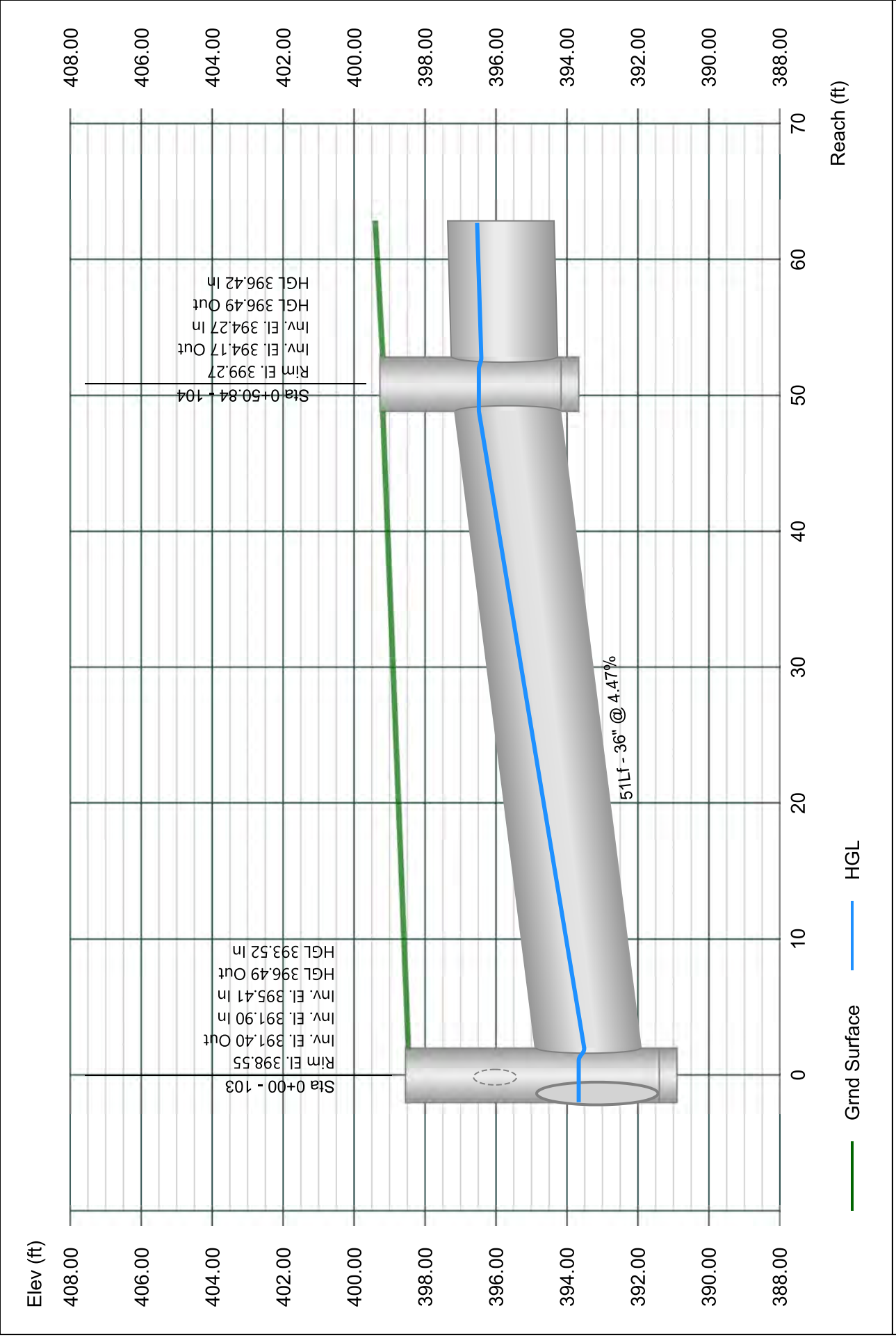

Line 5 - 105 TO 104

Stormwater Studio 2024 v 3.0.0.33

Project Name: Enter Project Name...

01-19-2024

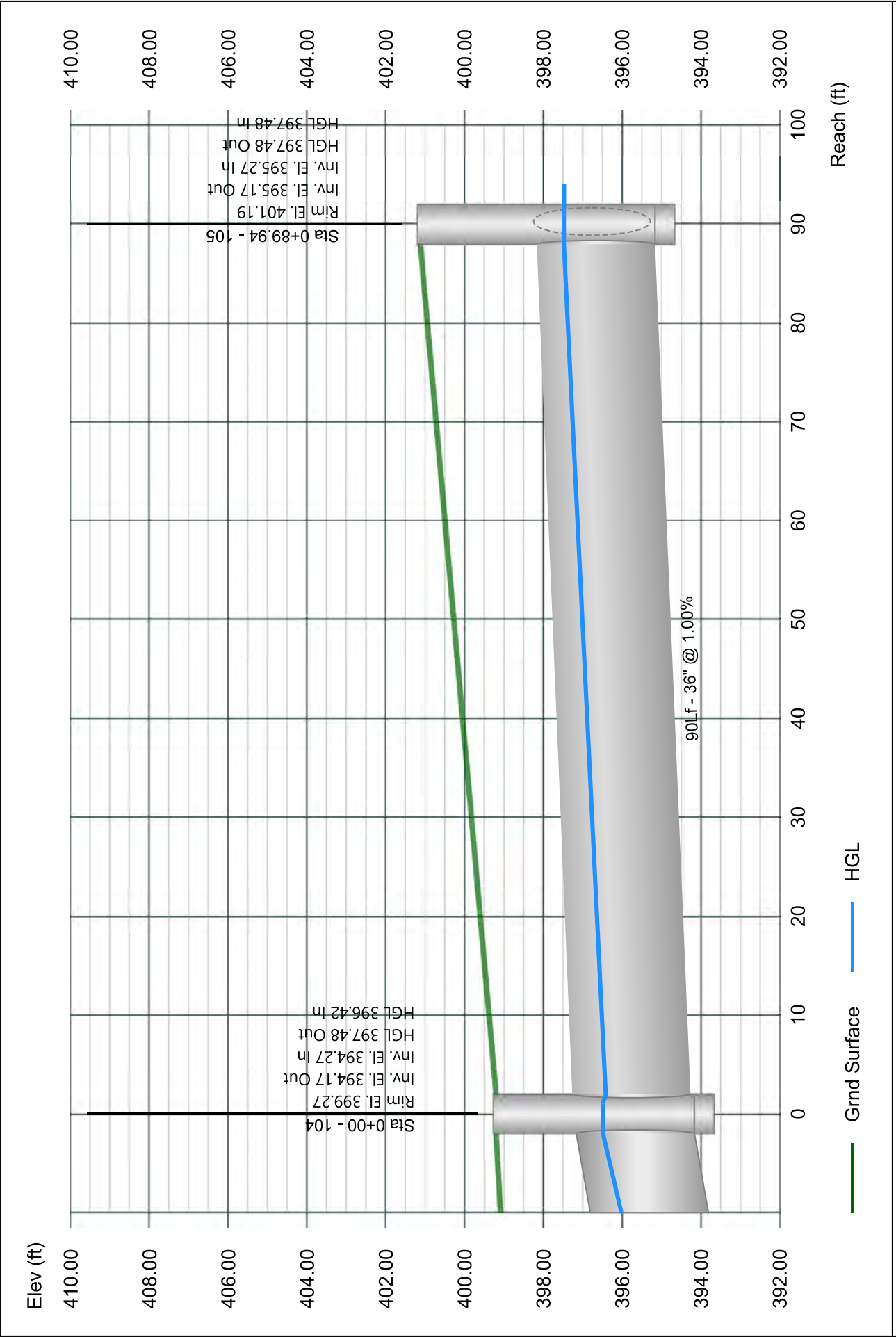

Line 6 - 106 TO 105

Stormwater Studio 2024 v 3.0.0.33

Project Name: Enter Project Name...

01-19-2024

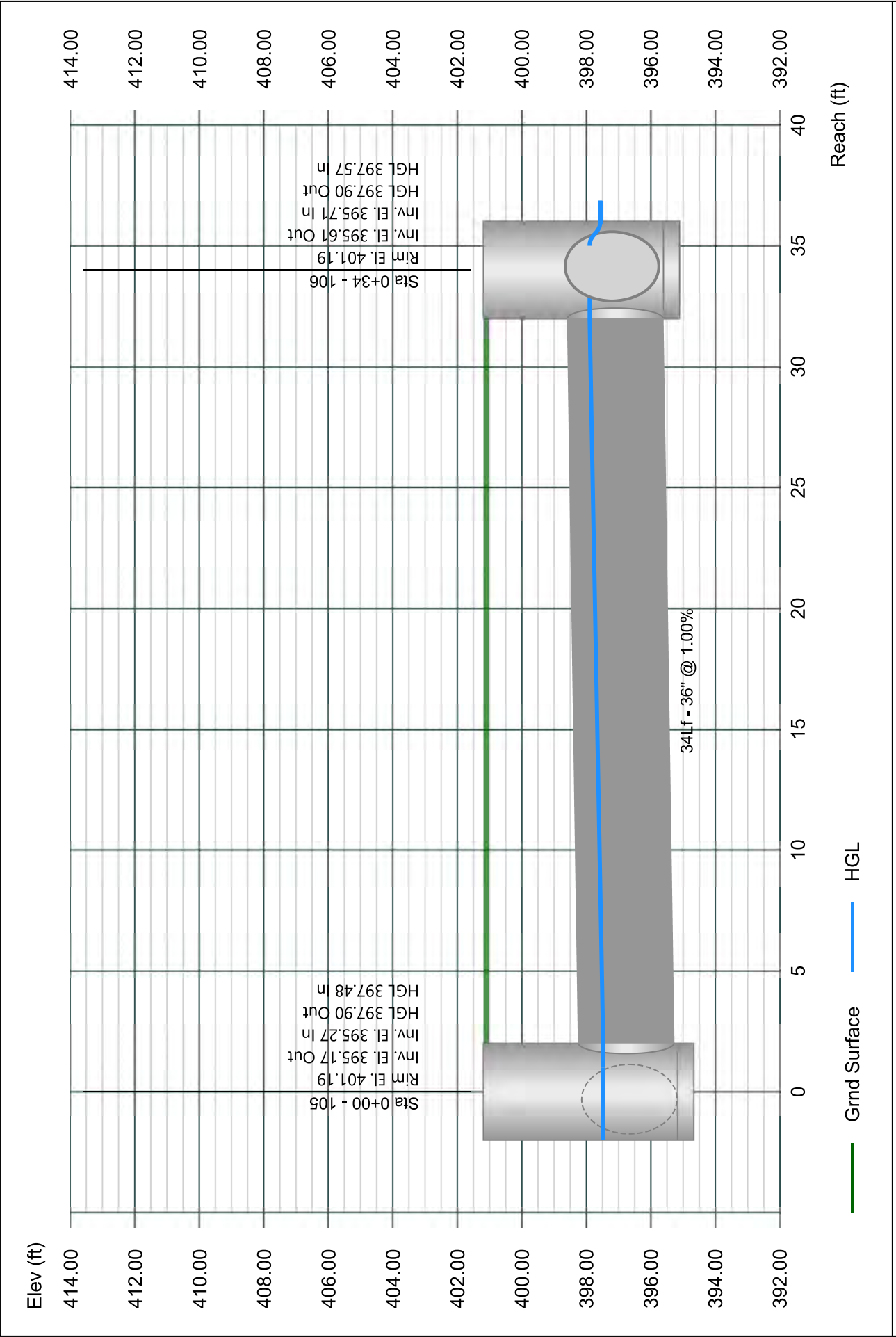

Line 7 - 107 TO 106

Stormwater Studio 2024 v 3.0.0.33

Project Name: Enter Project Name...

01-19-2024

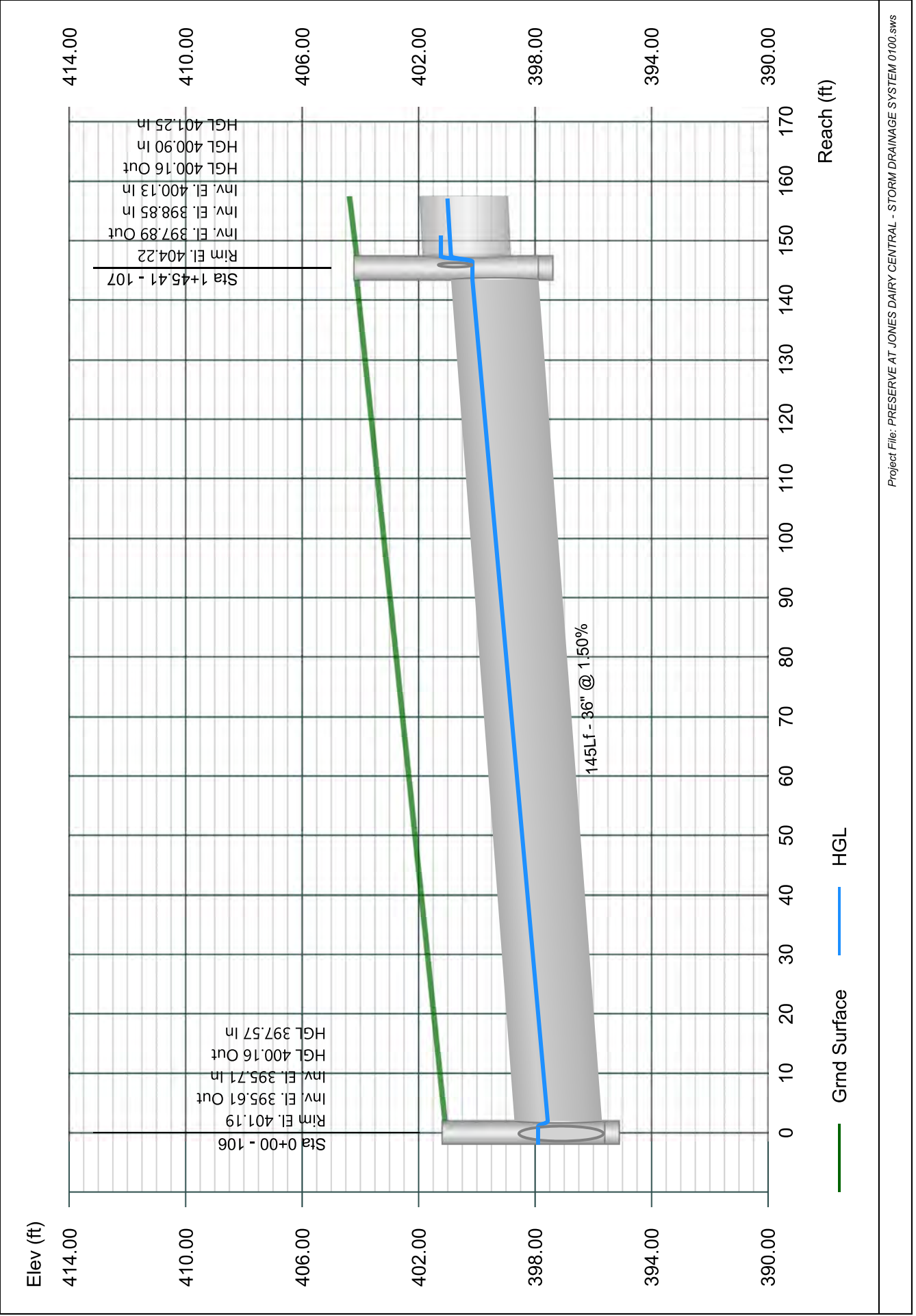

Line 8 - 108 TO 107

Stormwater Studio 2024 v 3.0.0.33

Project Name: Enter Project Name...

01-19-2024

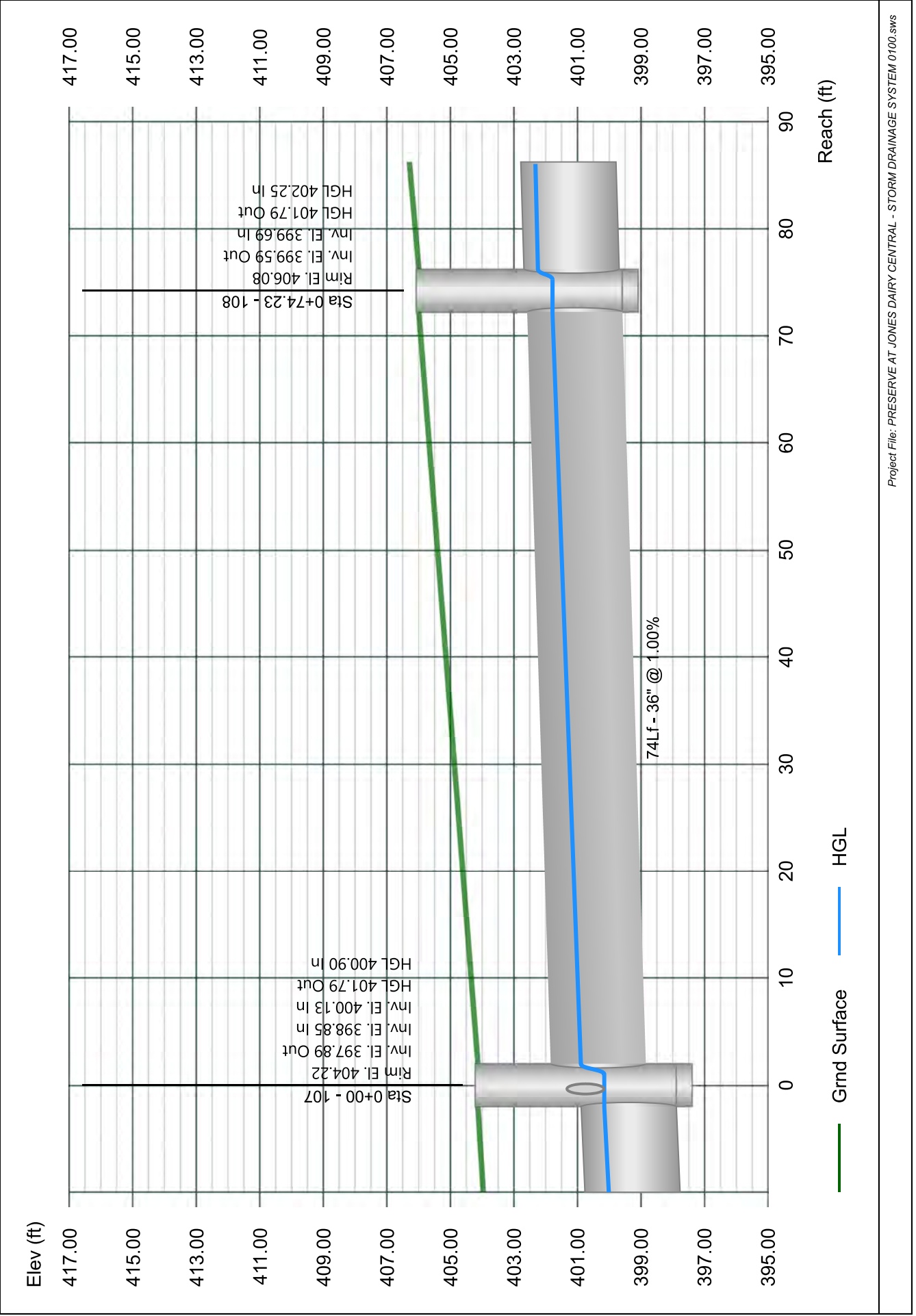

Line 9 - 109 TO 108

Stormwater Studio 2024 v 3.0.0.33

Project Name: Enter Project Name...

01-19-2024

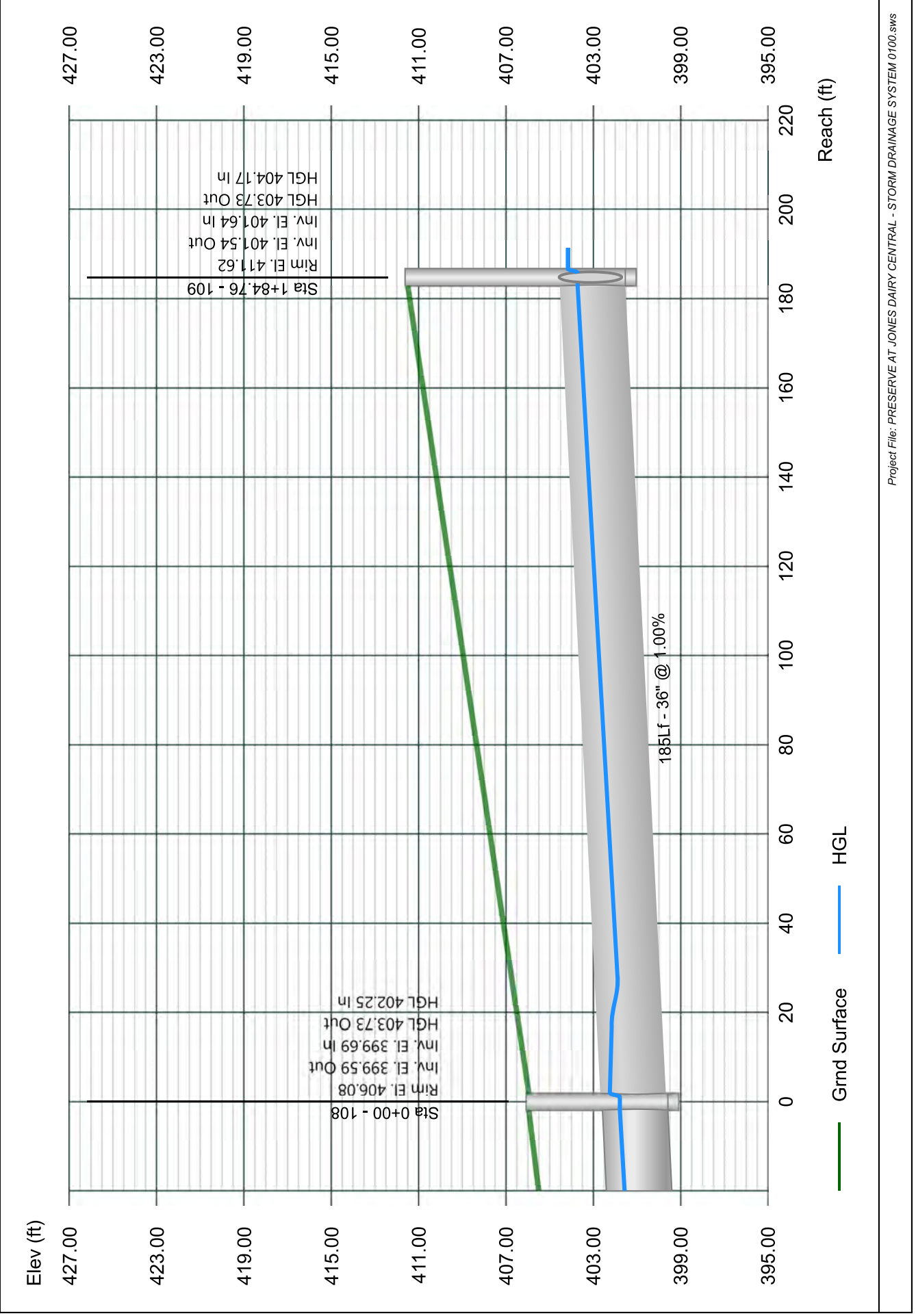

Line 10 - 110 TO 109

Stormwater Studio 2024 v 3.0.0.33

Project Name: Enter Project Name...

01-19-2024

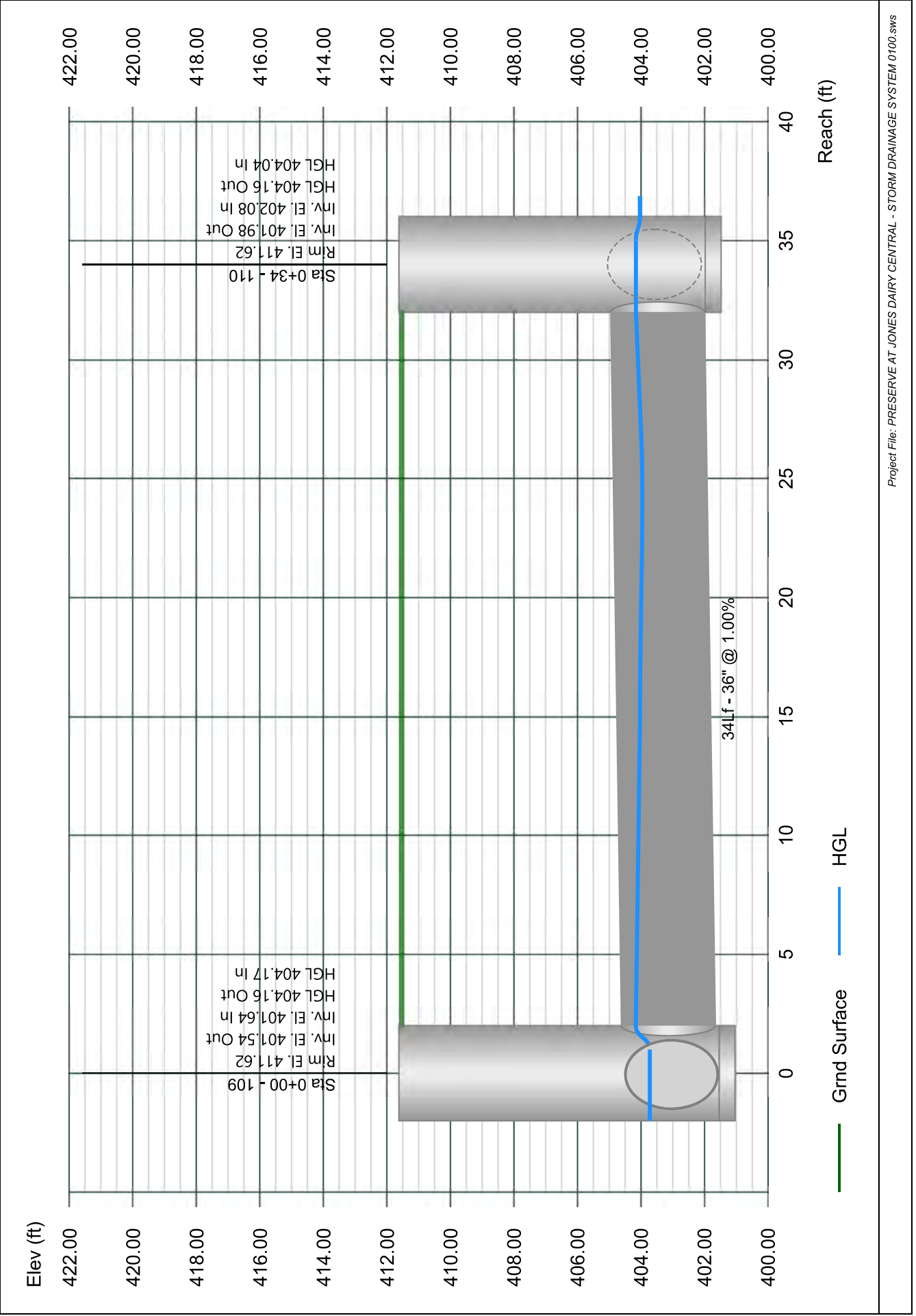

Line 11 - 111 TO 110

Stormwater Studio 2024 v 3.0.0.33

Project Name: Enter Project Name...

01-19-2024

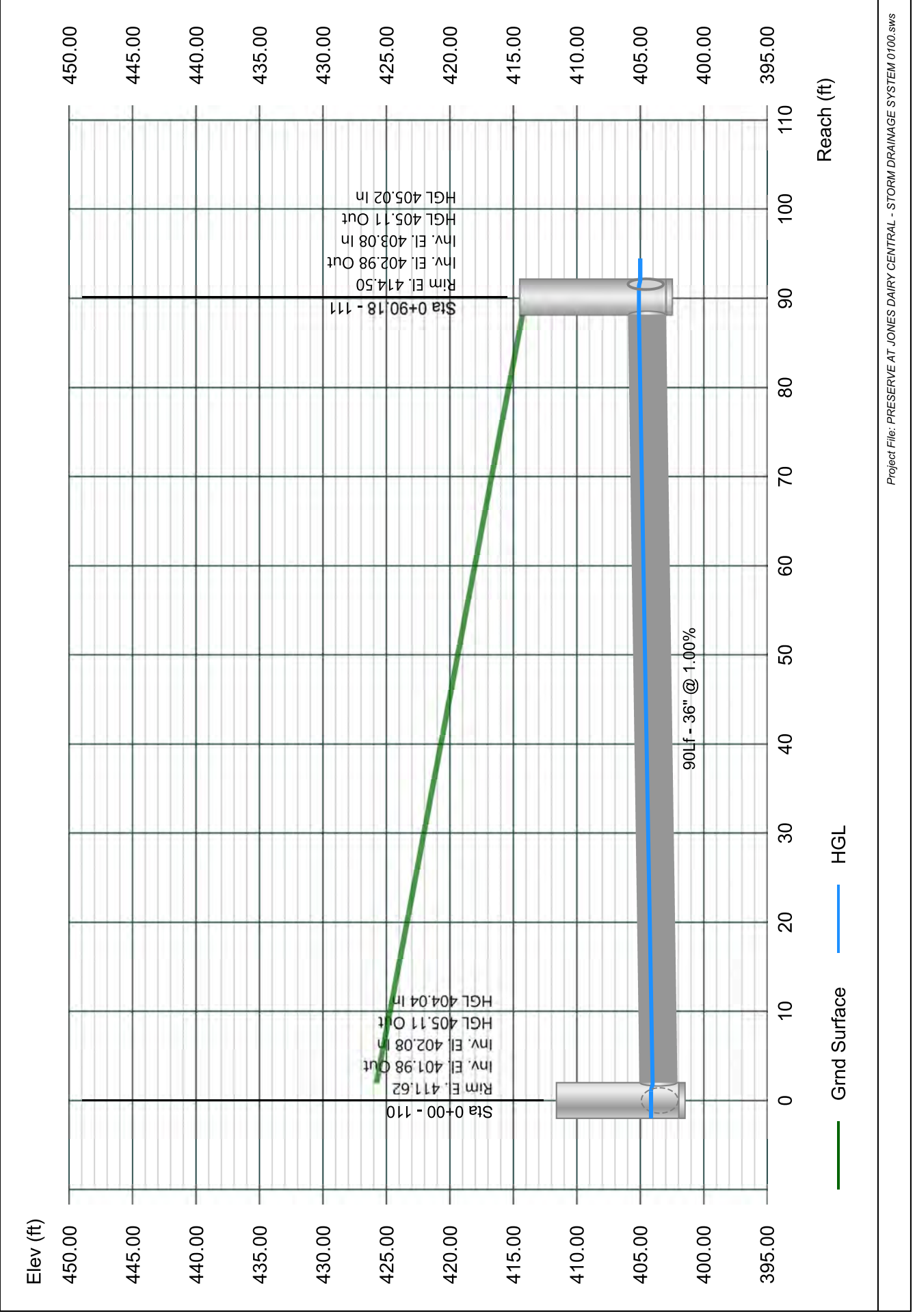

Line 12 - 112 TO 111

Stormwater Studio 2024 v 3.0.0.33

Project Name: Enter Project Name...

01-19-2024

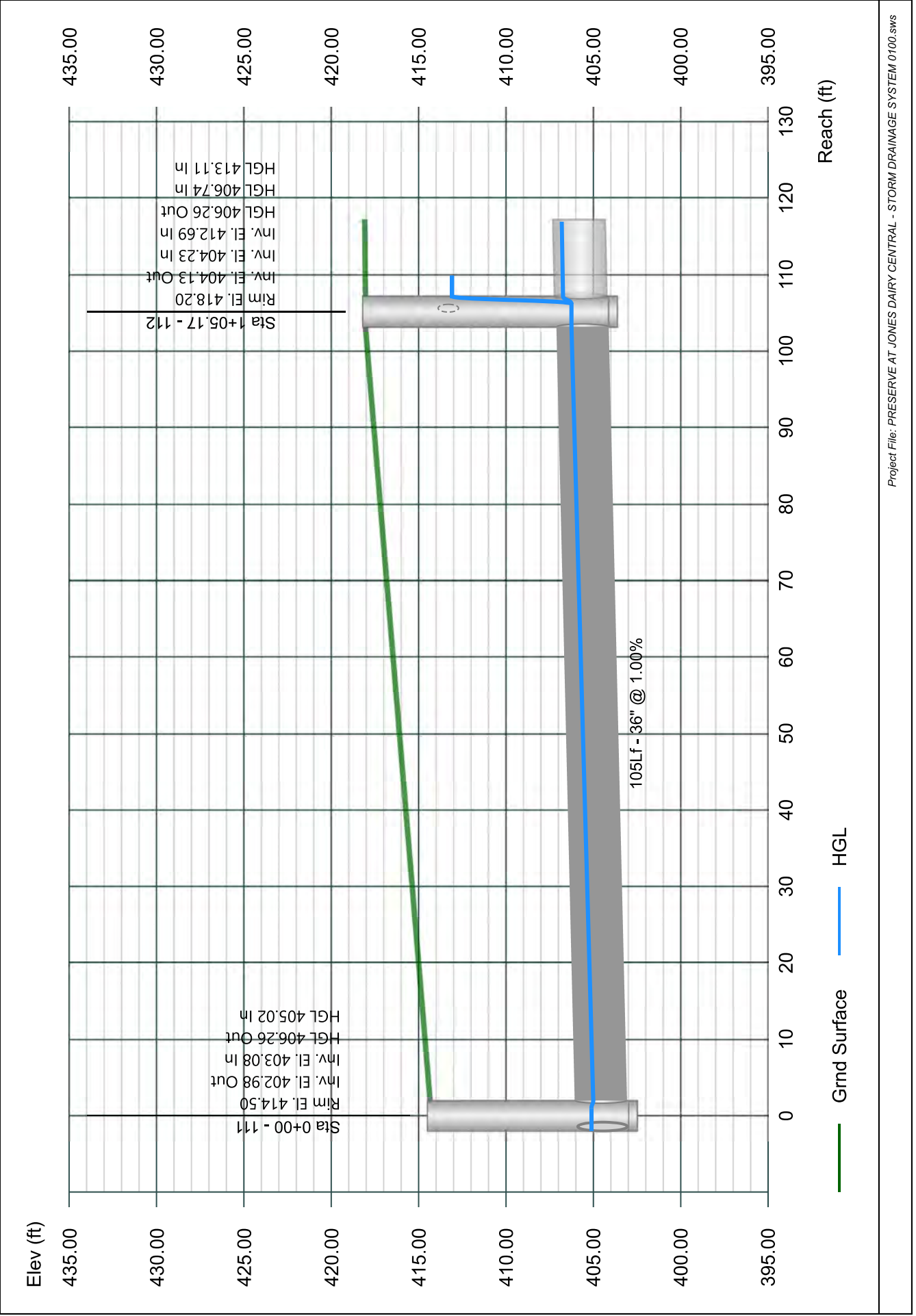

Line 13 - 113 TO 112

Stormwater Studio 2024 v 3.0.0.33

Project Name: Enter Project Name...

01-19-2024

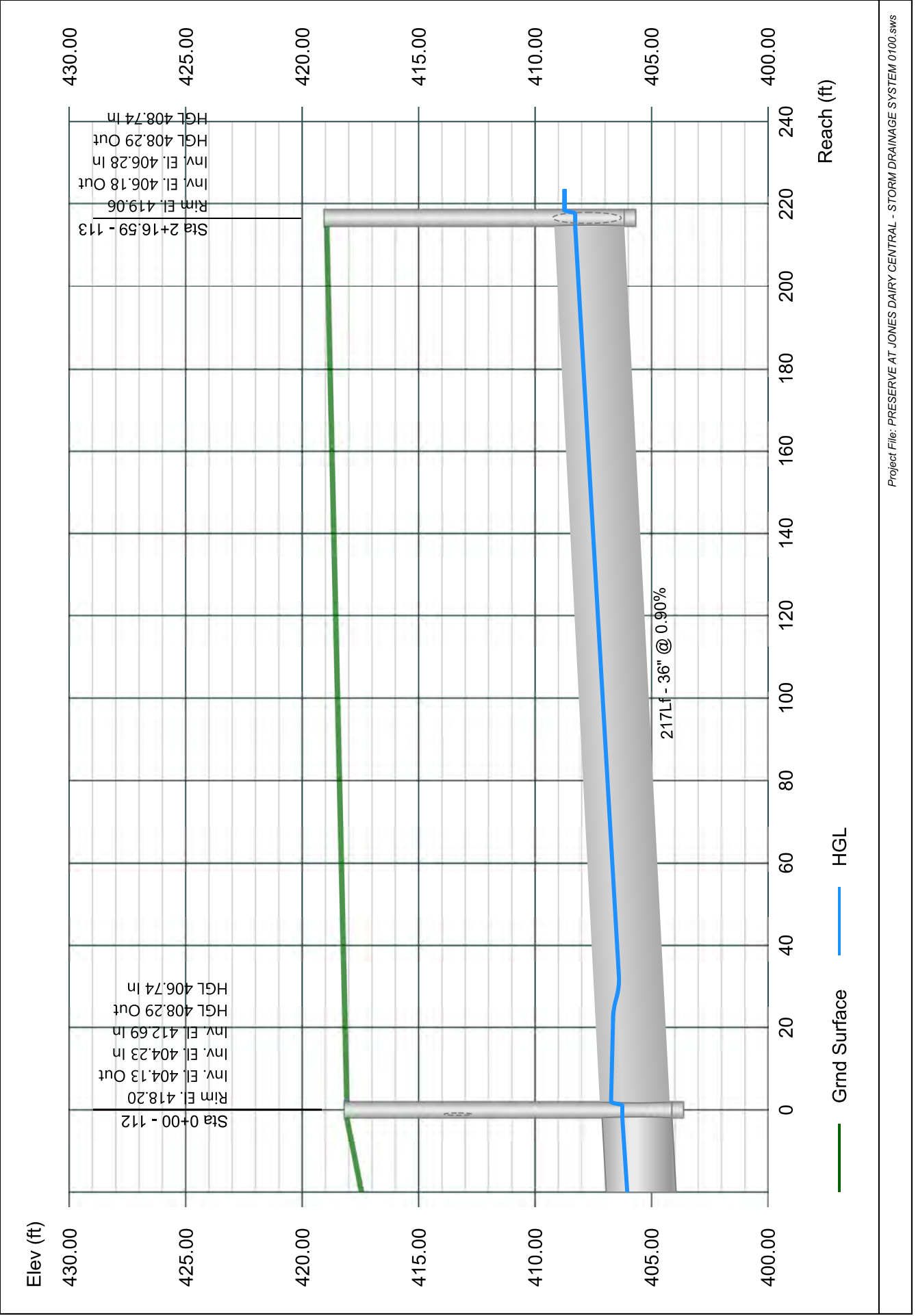

Line 14 - 114 TO 113

Stormwater Studio 2024 v 3.0.0.33

Project Name: Enter Project Name...

01-19-2024

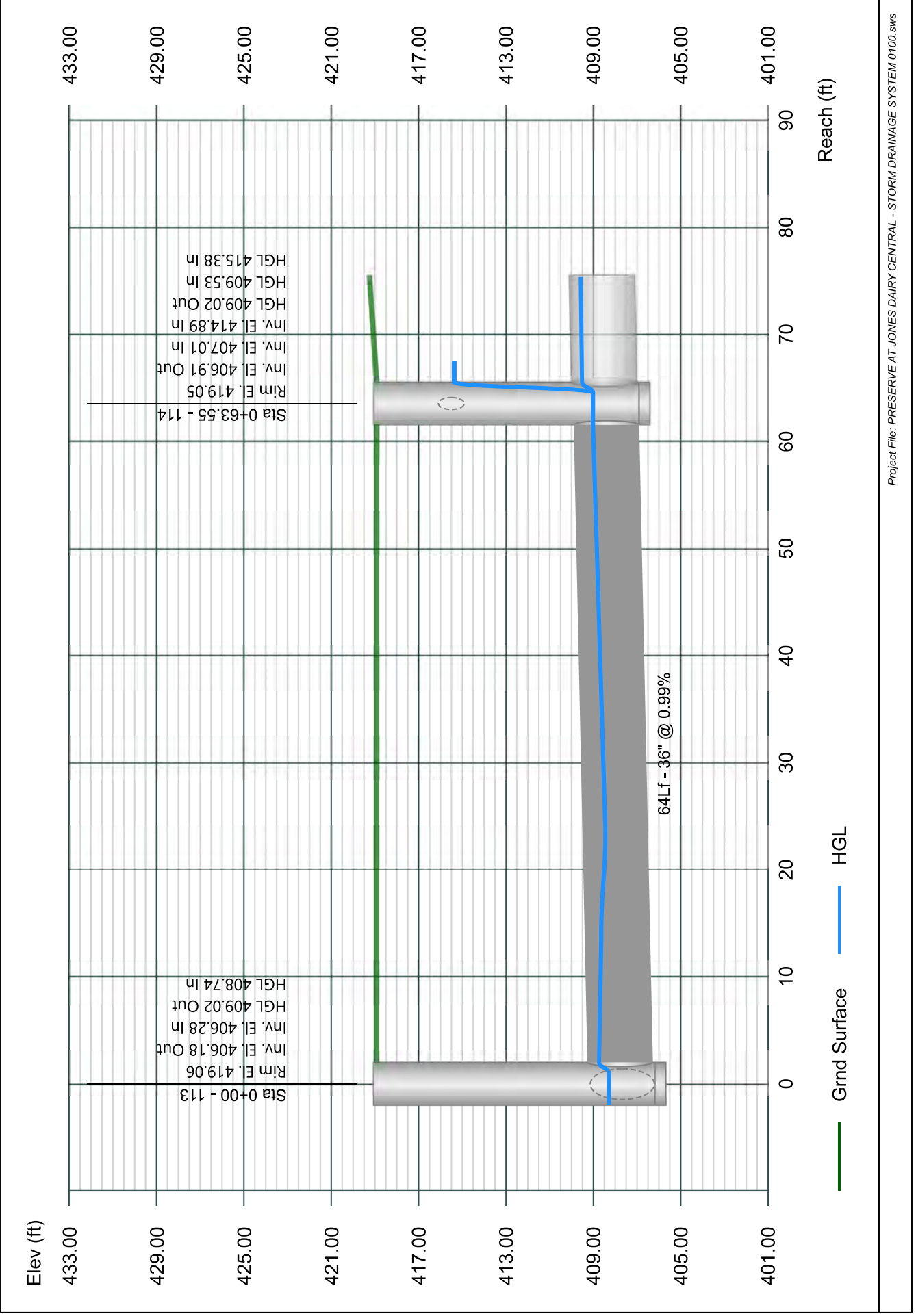

Line 15 - 115 TO 114

Stormwater Studio 2024 v 3.0.0.33

Project Name: Enter Project Name...

01-19-2024

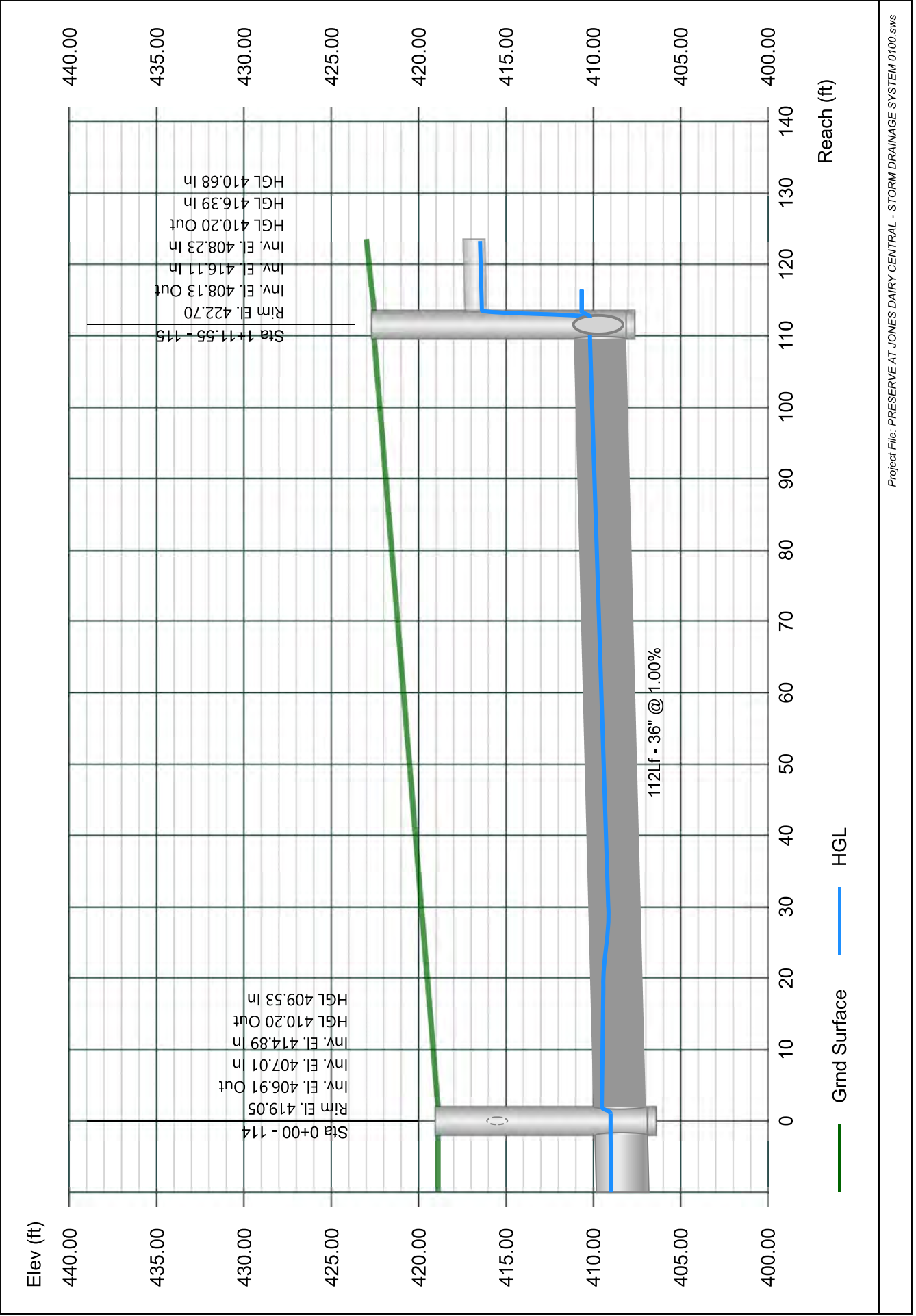

Line 16 - 116 TO 115

Stormwater Studio 2024 v 3.0.0.33

Project Name: Enter Project Name...

01-19-2024

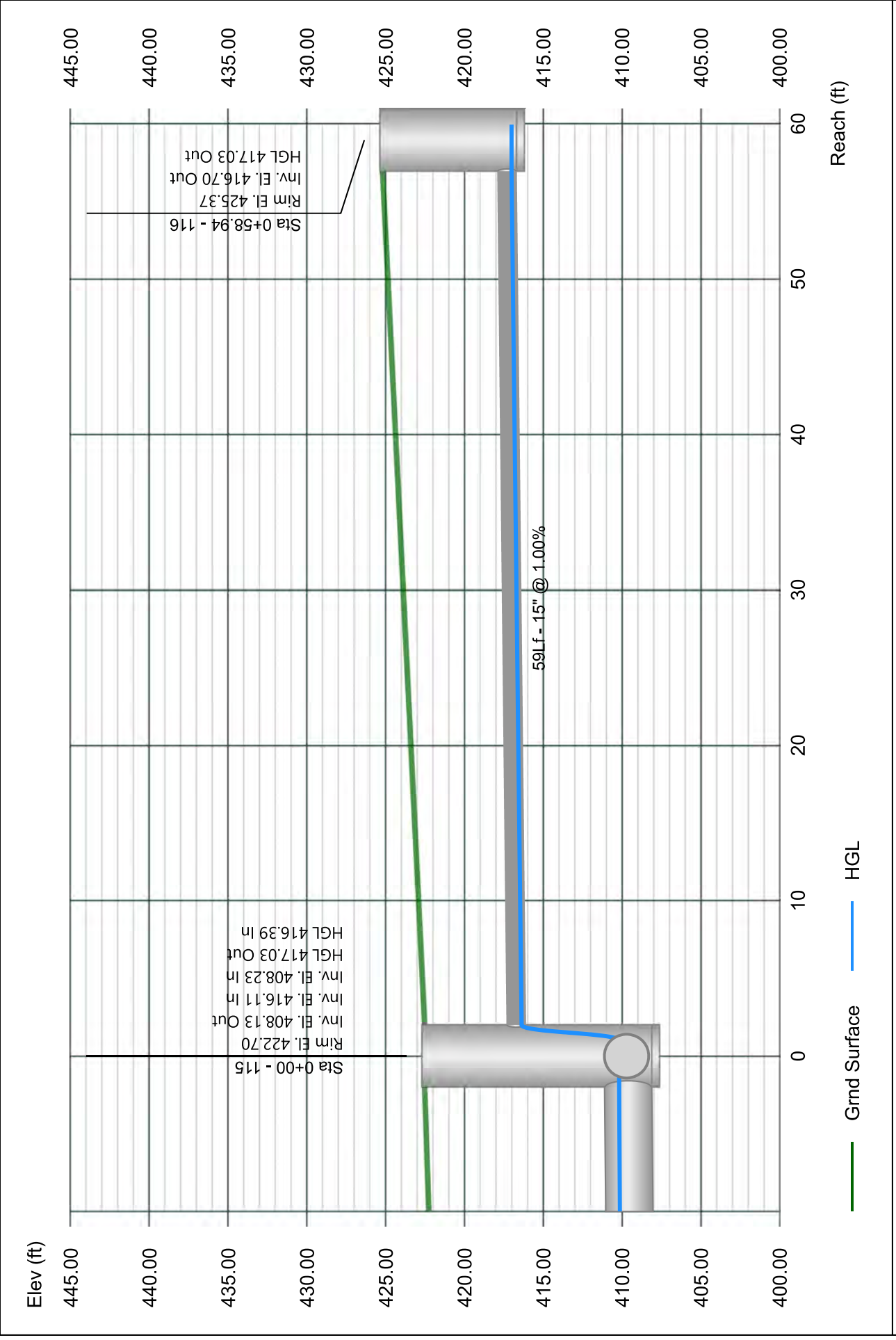

Line 17 - 117 TO 115

Stormwater Studio 2024 v 3.0.0.33

Project Name: Enter Project Name...

01-19-2024

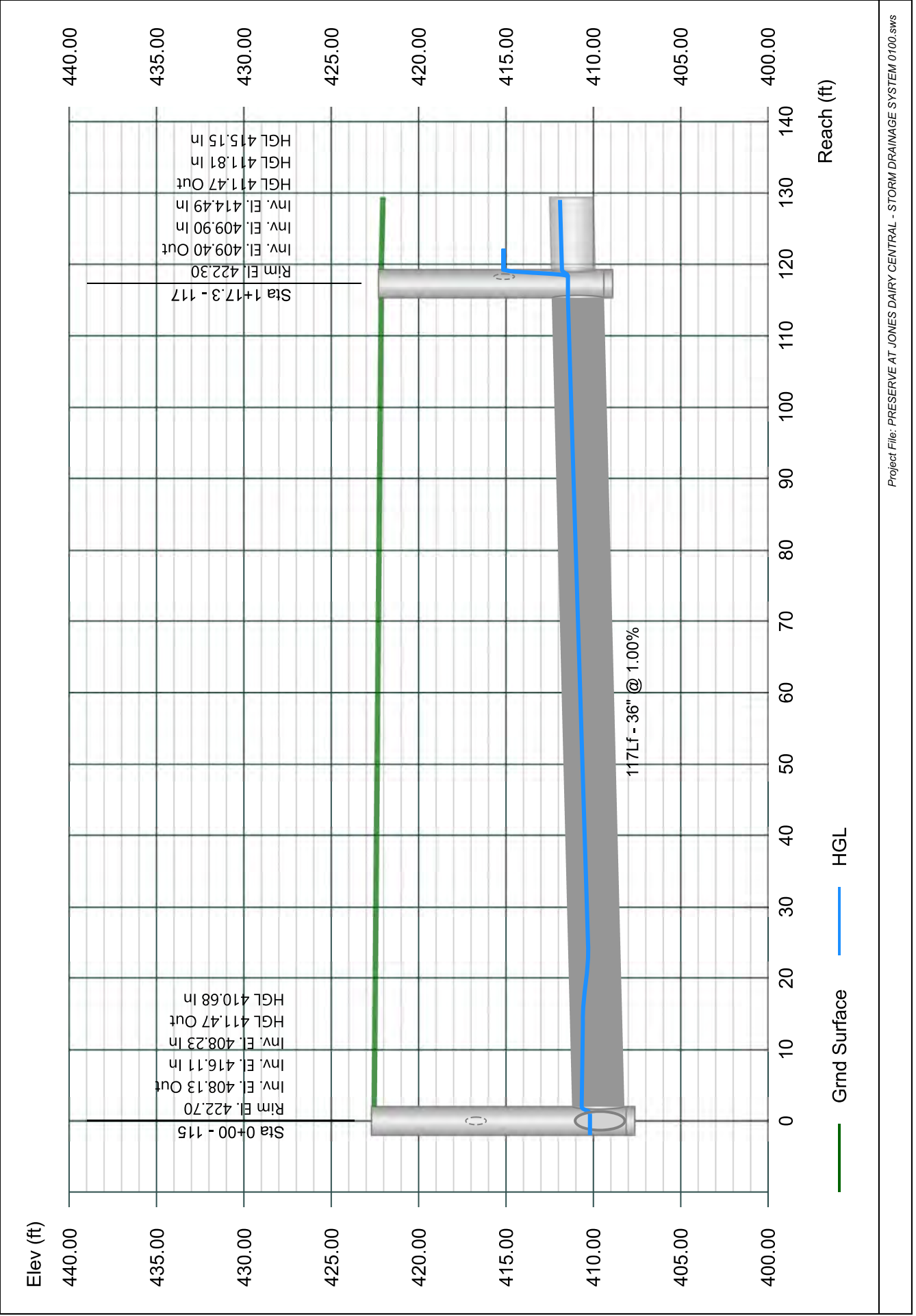

Line 18 - 118 TO 117

Stormwater Studio 2024 v 3.0.0.33

Project Name: Enter Project Name...

01-19-2024

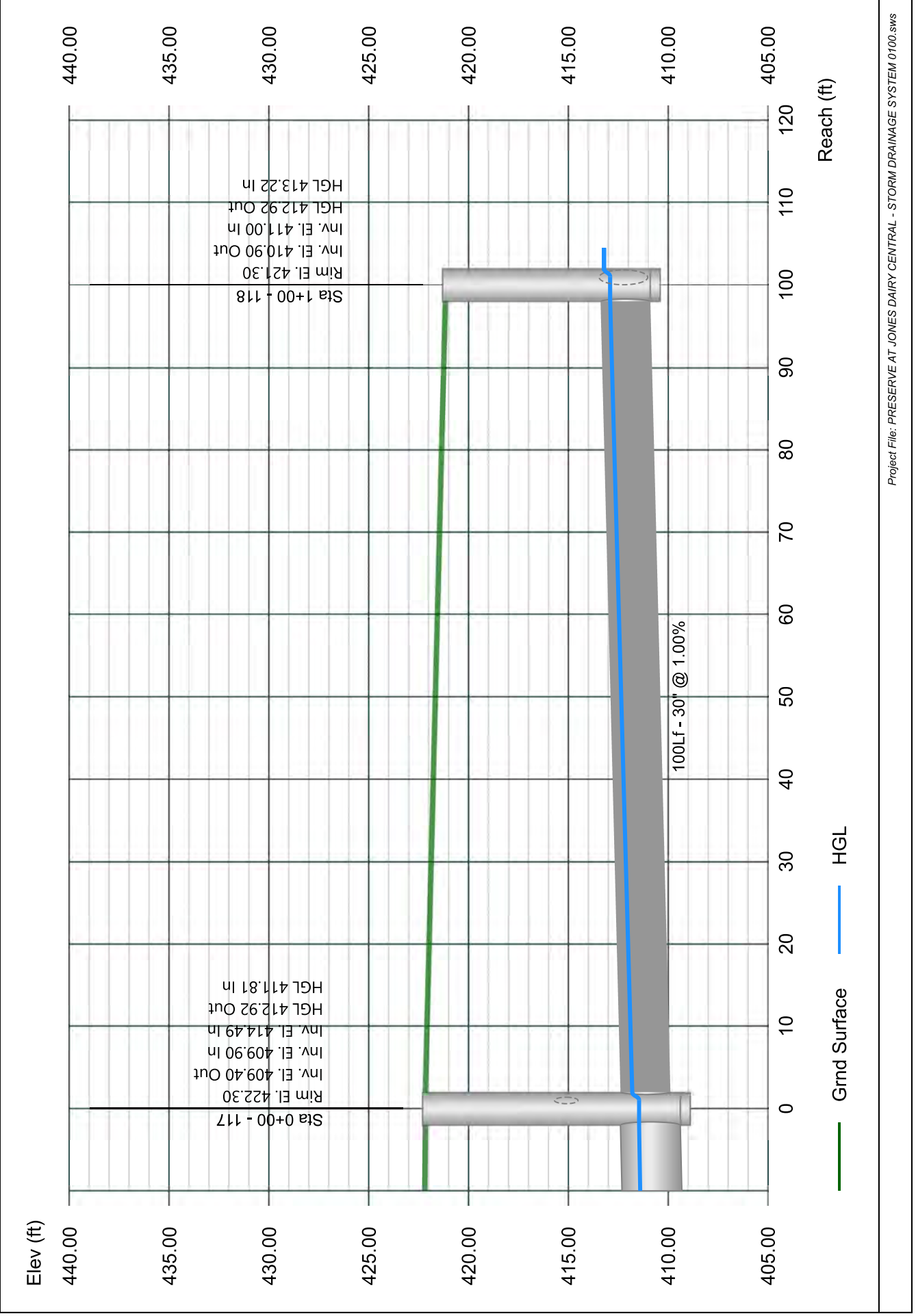

Line 19 - 119 TO 118

Stormwater Studio 2024 v 3.0.0.33

Project Name: Enter Project Name...

01-19-2024

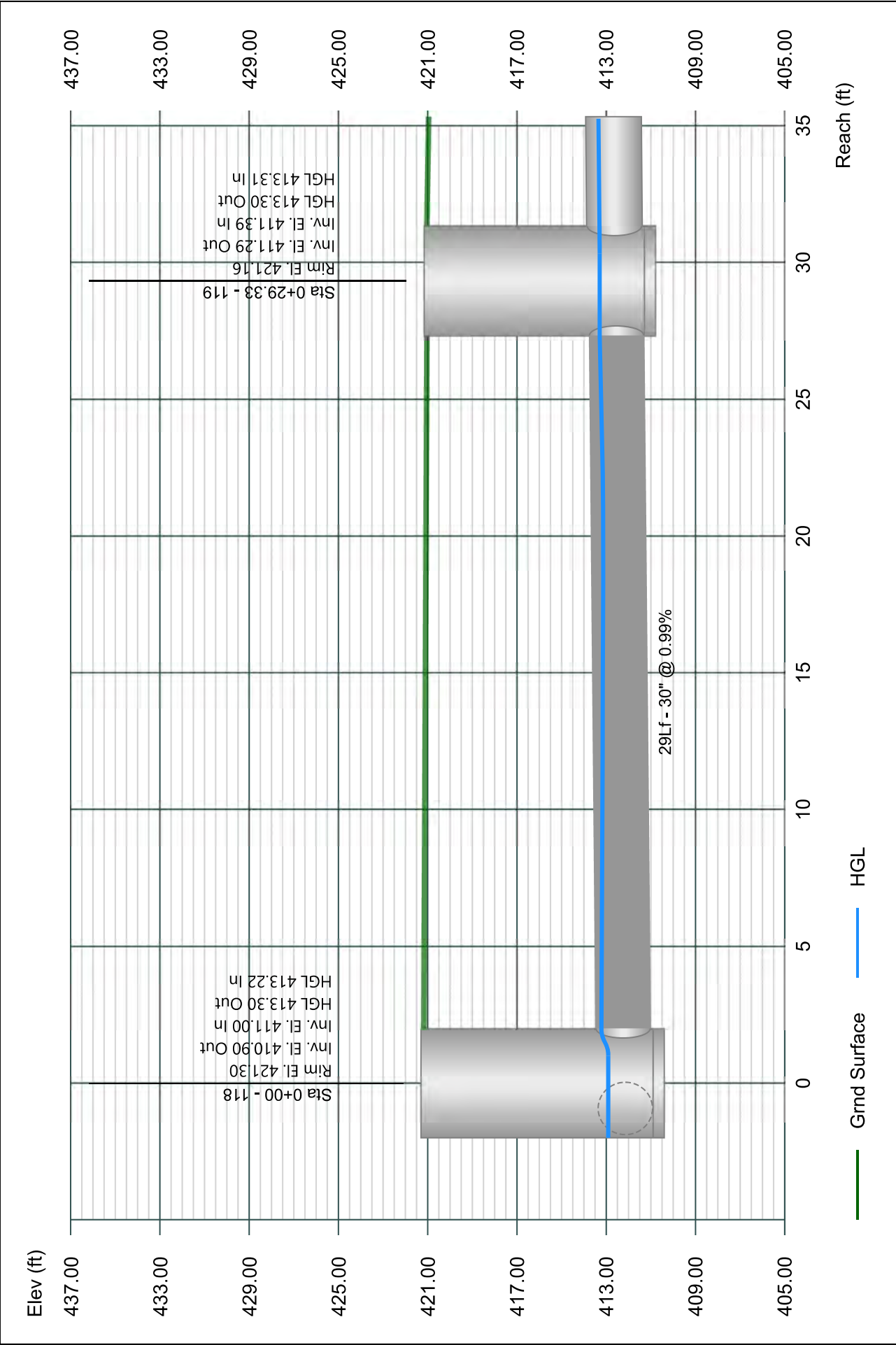

Line 20 - 120 TO 119

Stormwater Studio 2024 v 3.0.0.33

Project Name: Enter Project Name...

01-19-2024

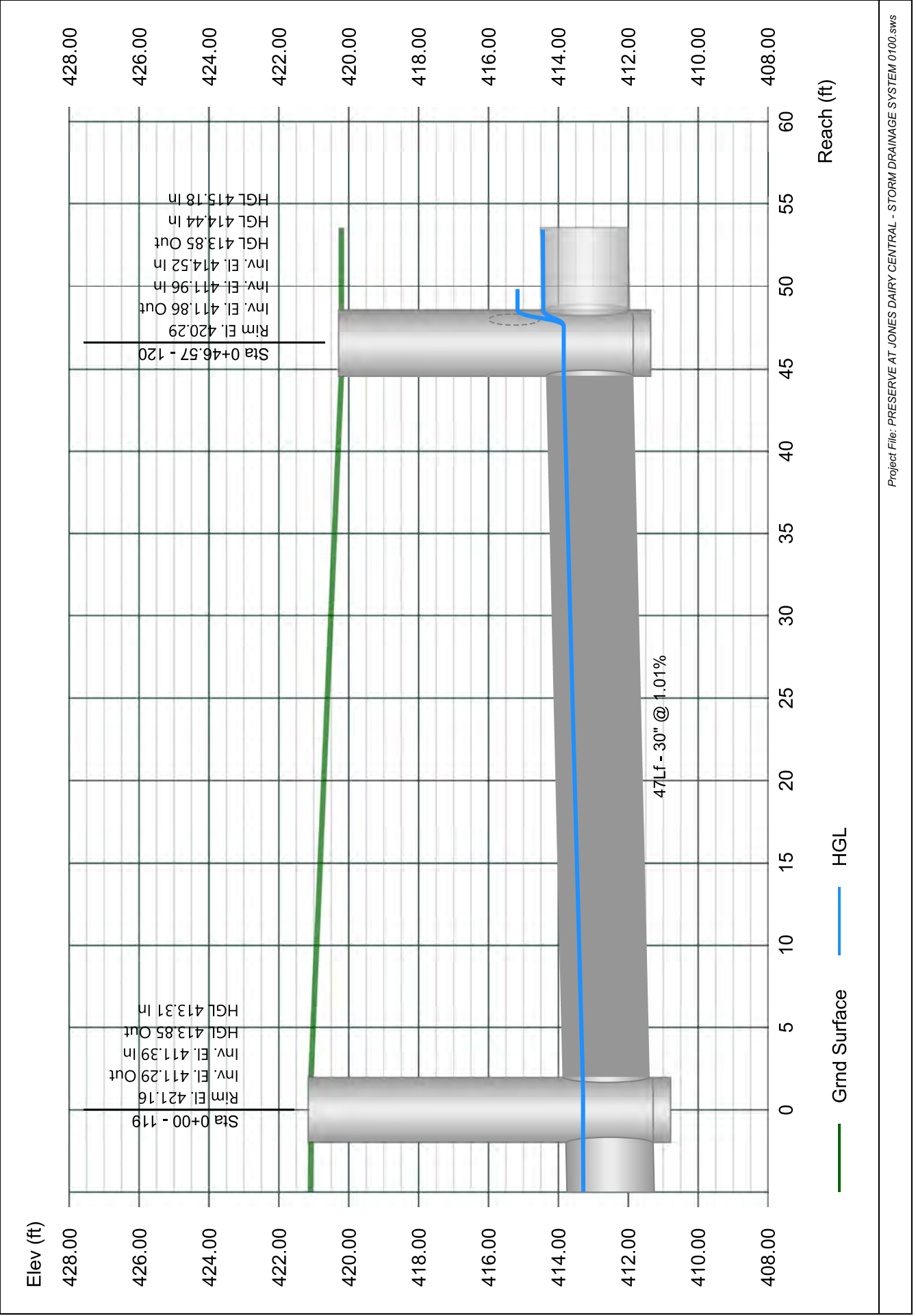

Line 21 - 121 TO 120

Stormwater Studio 2024 v 3.0.0.33

Project Name: Enter Project Name...

01-19-2024

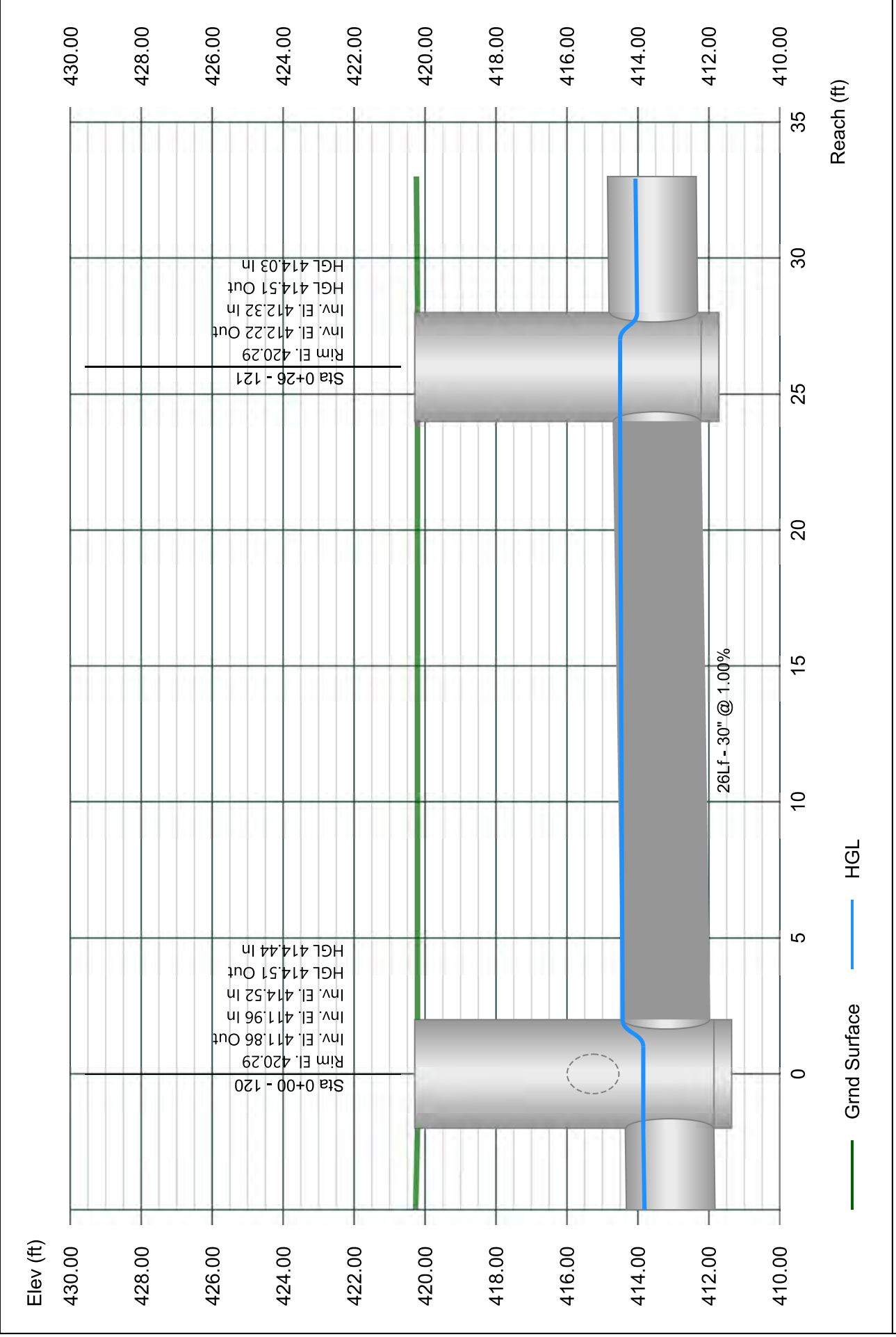

Line 22 - 122 TO 121

Stormwater Studio 2024 v 3.0.0.33

Project Name: Enter Project Name...

01-19-2024

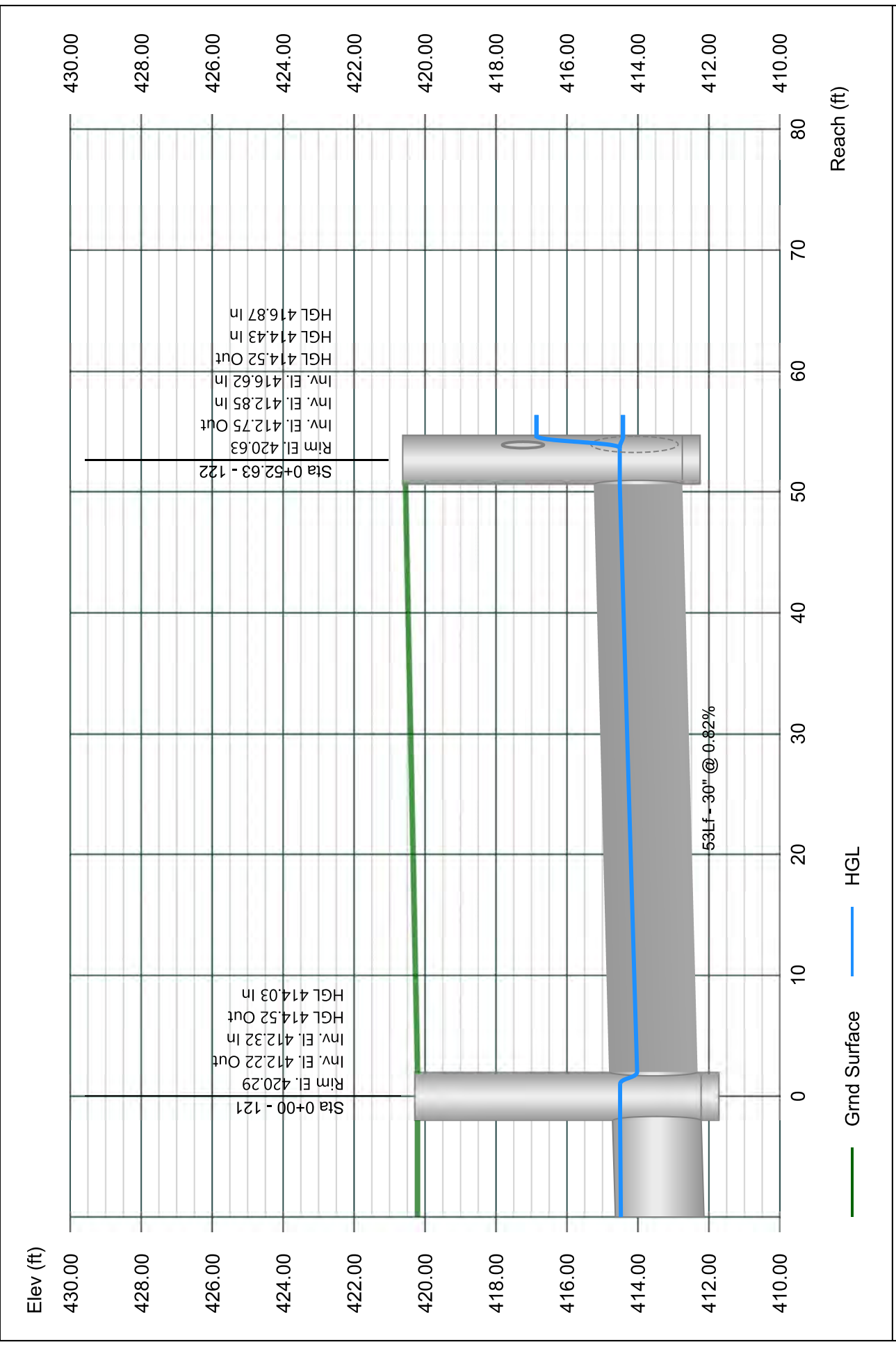

Line 23 - 123 TO 122

Stormwater Studio 2024 v 3.0.0.33

Project Name: Enter Project Name...

01-19-2024

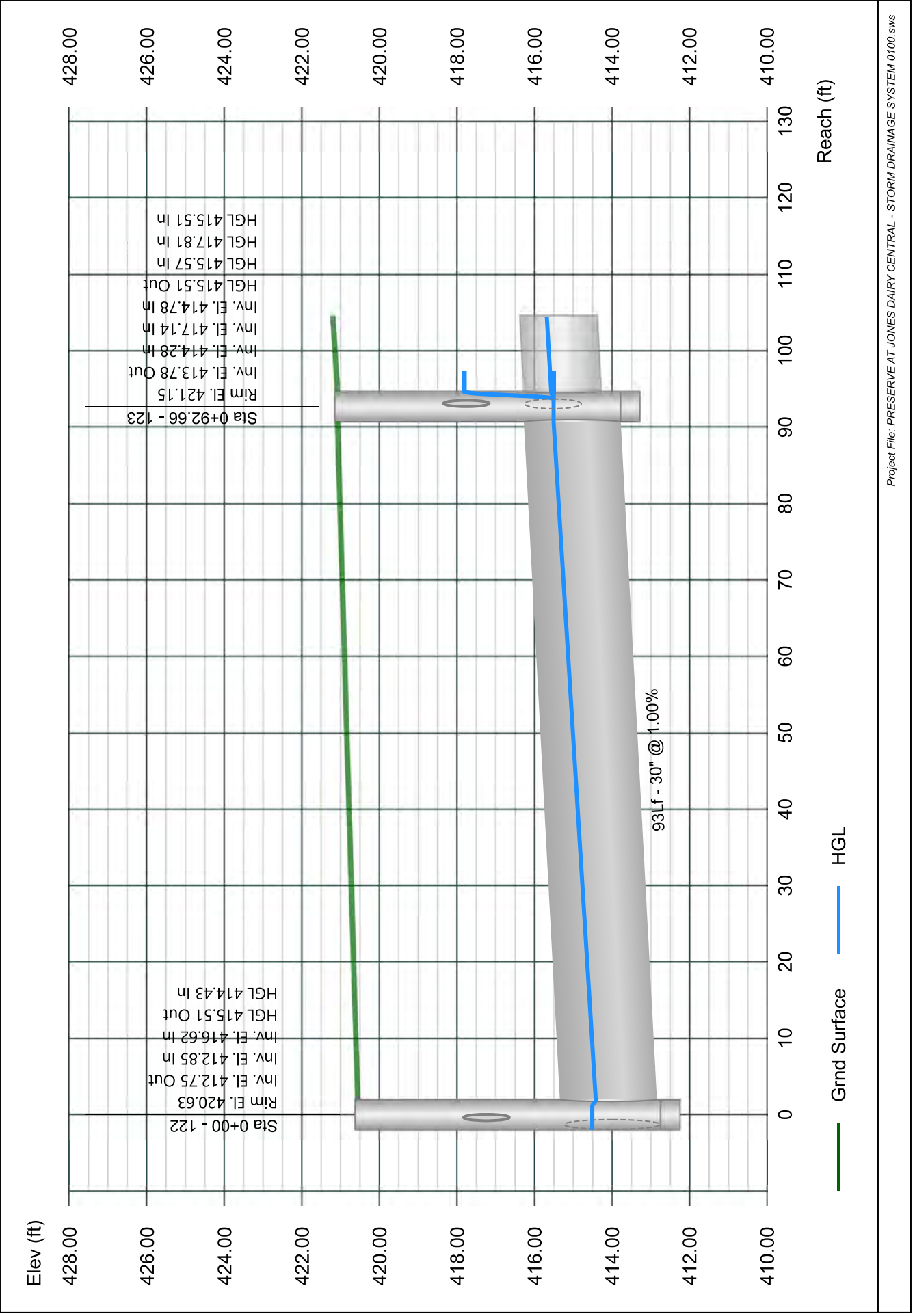

Line 24 - 124 TO 123

Stormwater Studio 2024 v 3.0.0.33

Project Name: Enter Project Name...

01-19-2024

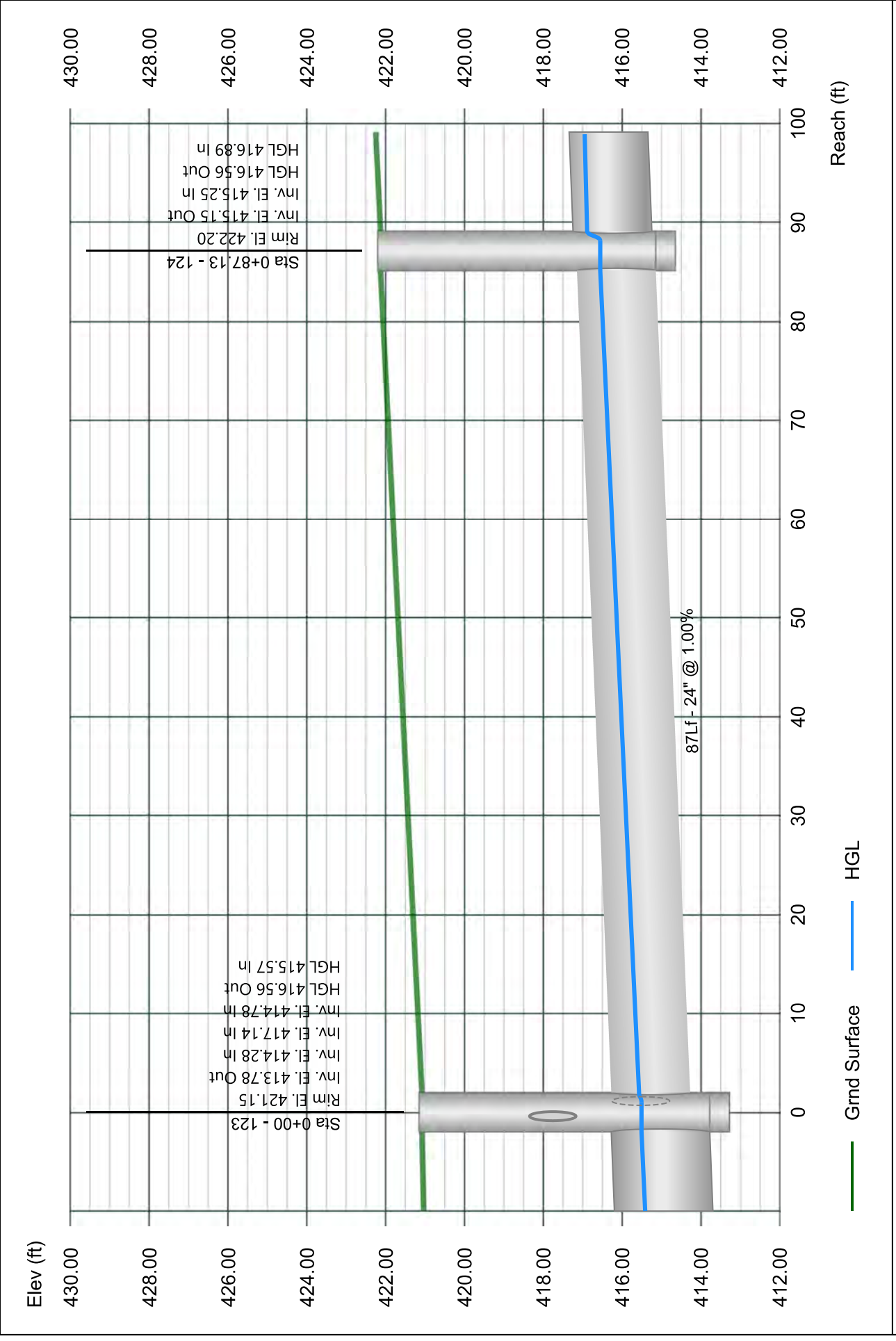

Line 25 - 125 TO 124

Stormwater Studio 2024 v 3.0.0.33

Project Name: Enter Project Name...

01-19-2024

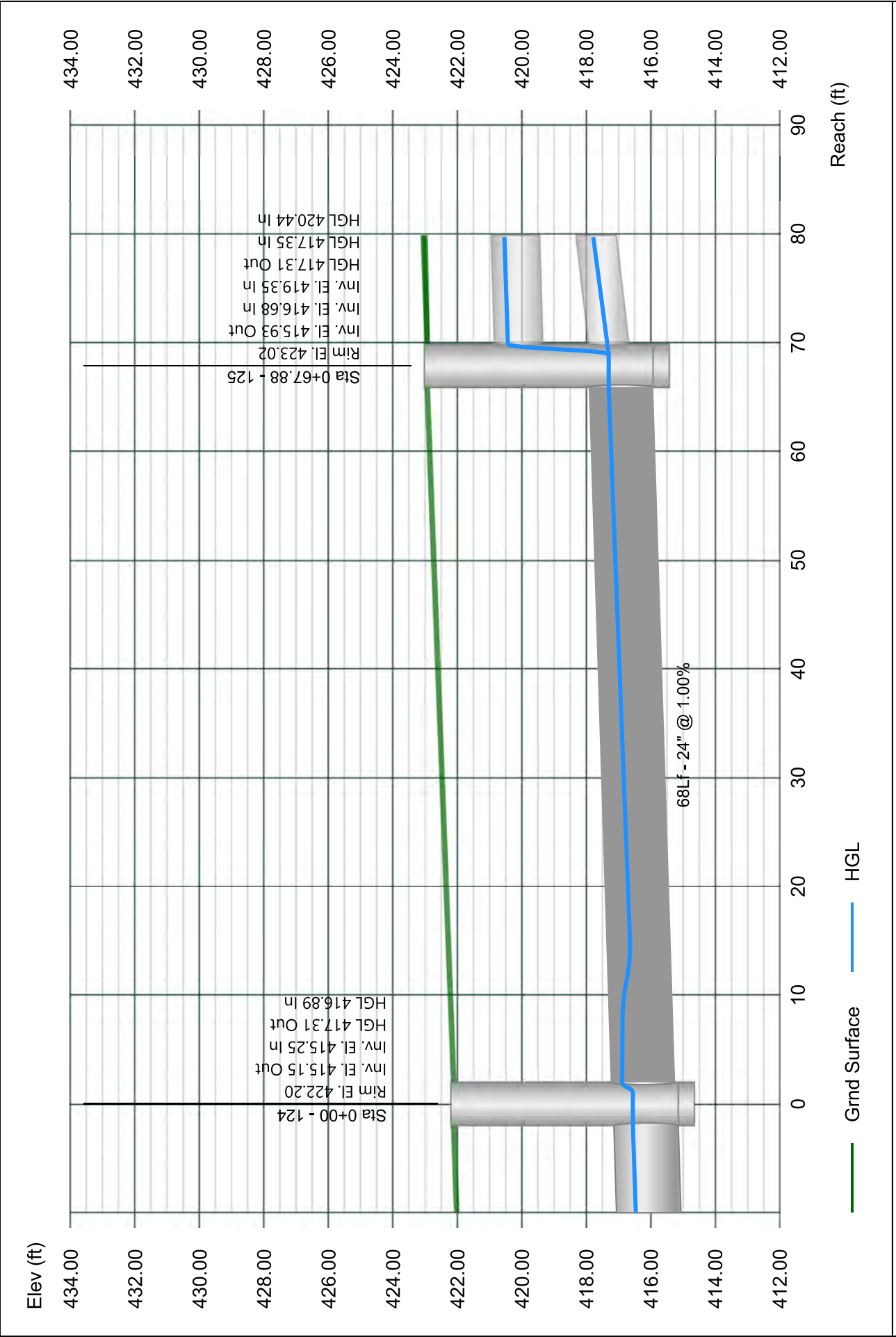

Line 26 - 126 TO 125

Stormwater Studio 2024 v 3.0.0.33

Project Name: Enter Project Name...

01-19-2024

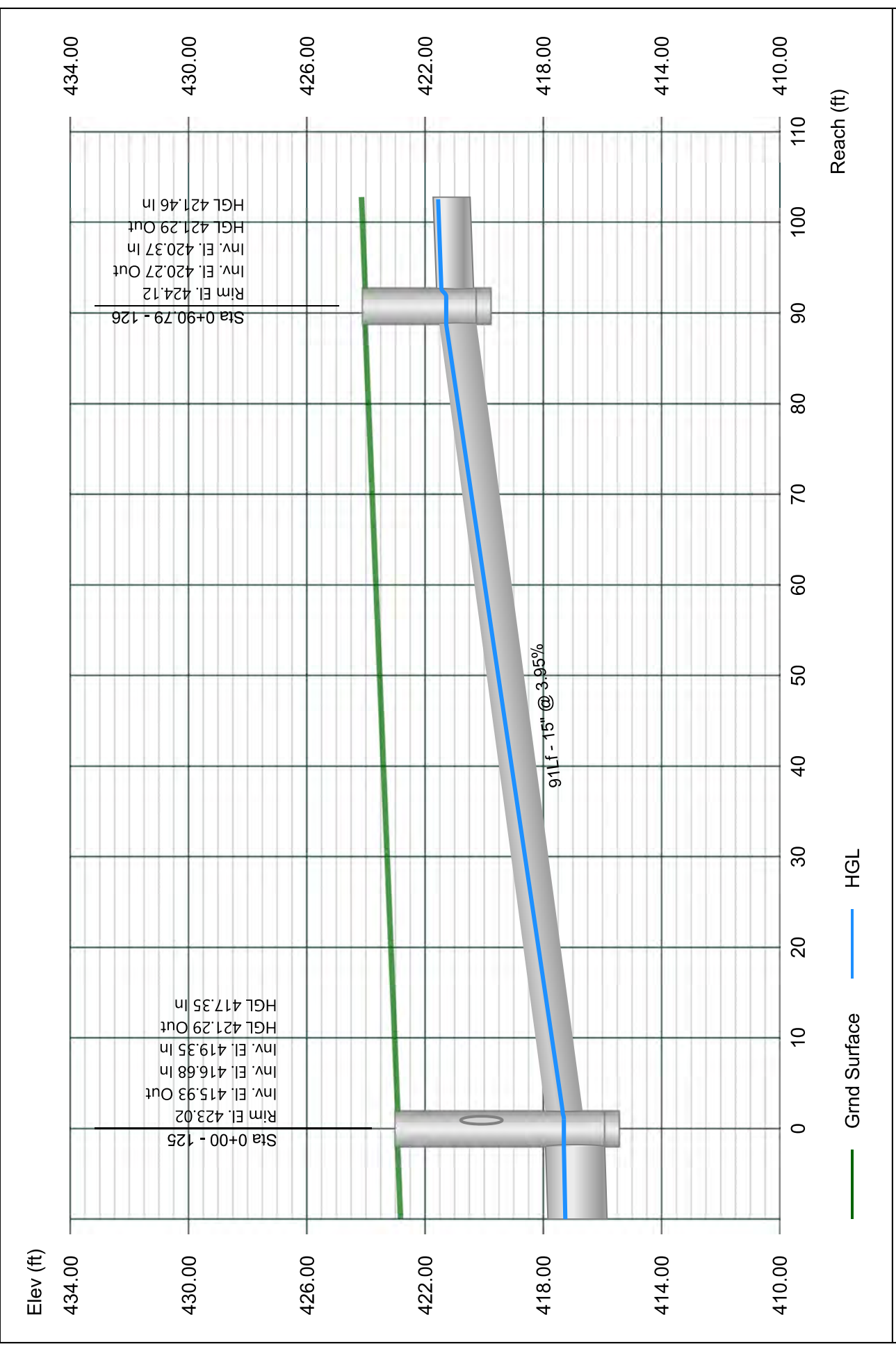

Line 27 - 127 TO 126

Stormwater Studio 2024 v 3.0.0.33

Project Name: Enter Project Name...

01-19-2024

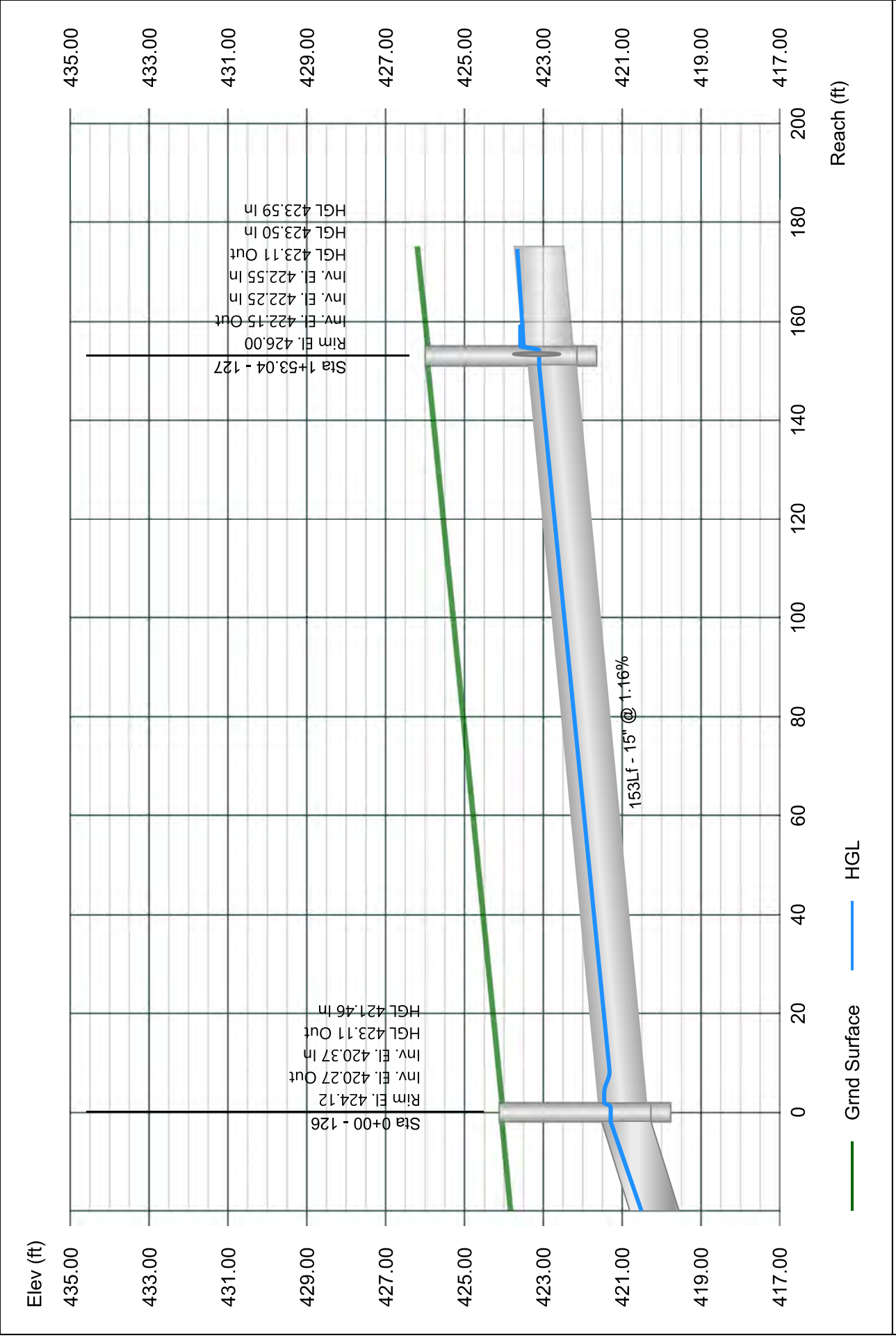

Line 28 - 128 TO 127

Stormwater Studio 2024 v 3.0.0.33

Project Name: Enter Project Name...

01-19-2024

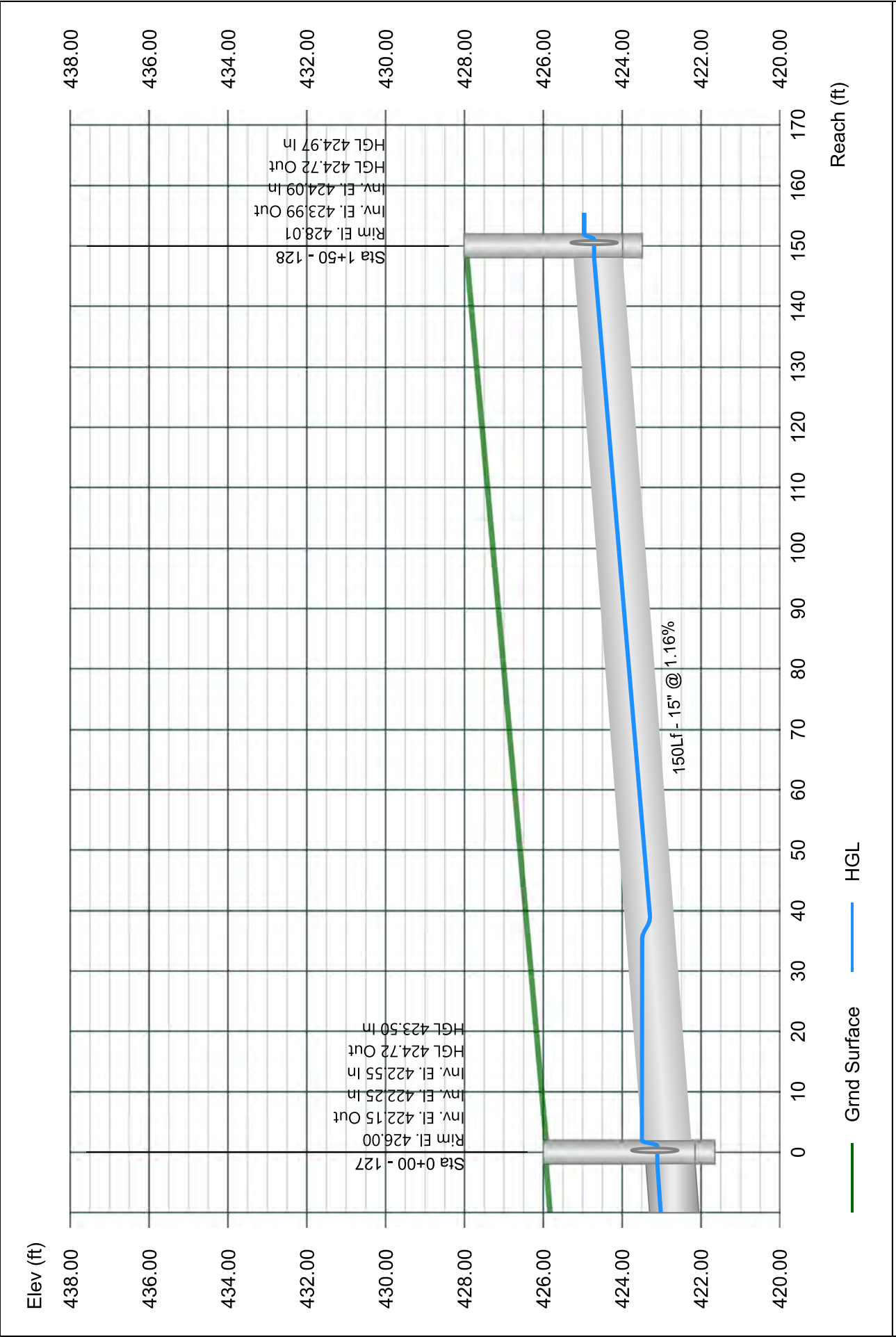

Line 29 - 129 TO 128

Stormwater Studio 2024 v 3.0.0.33

Project Name: Enter Project Name...

01-19-2024

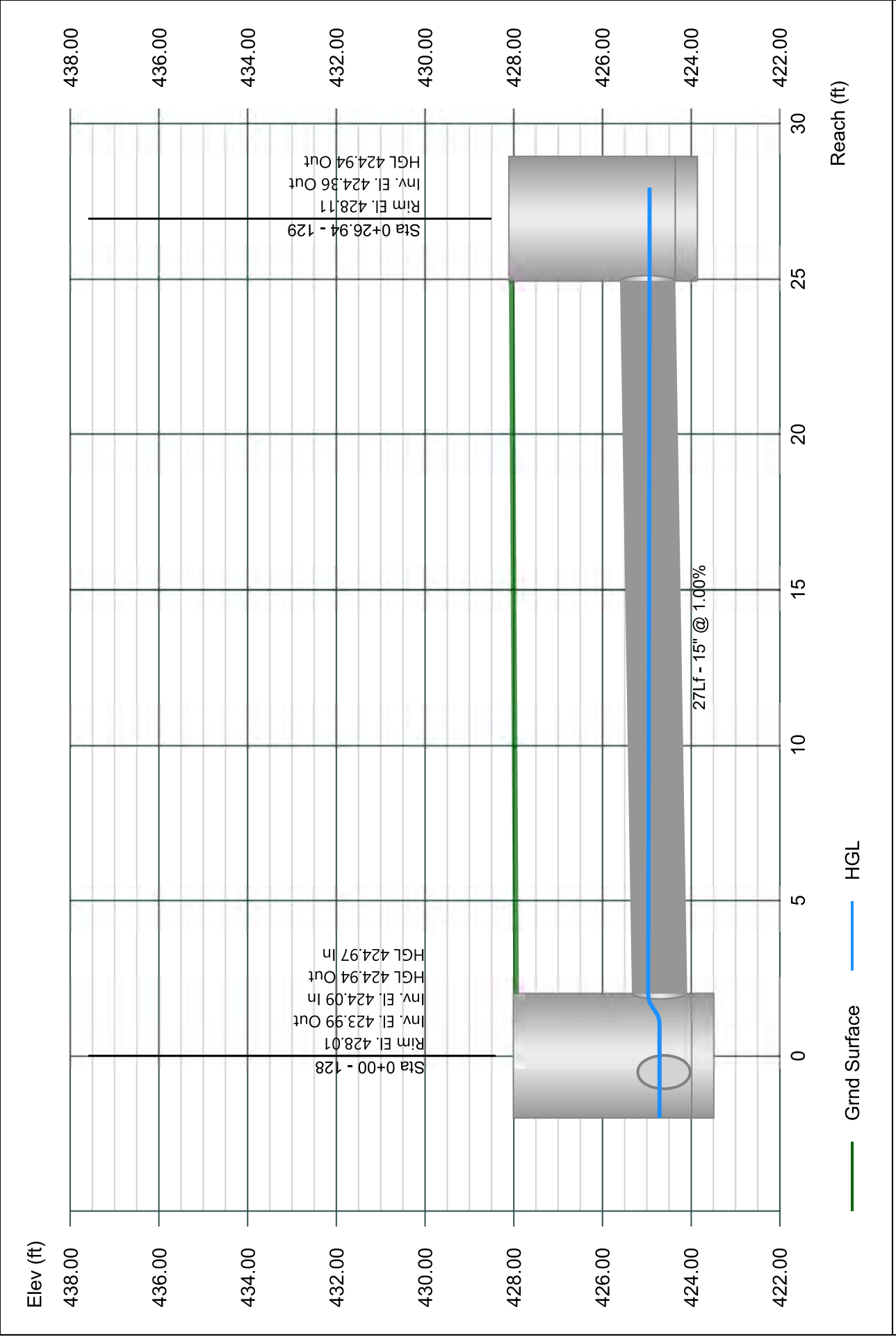

Line 30 - 130 TO 127

Stormwater Studio 2024 v 3.0.0.33

Project Name: Enter Project Name...

01-19-2024

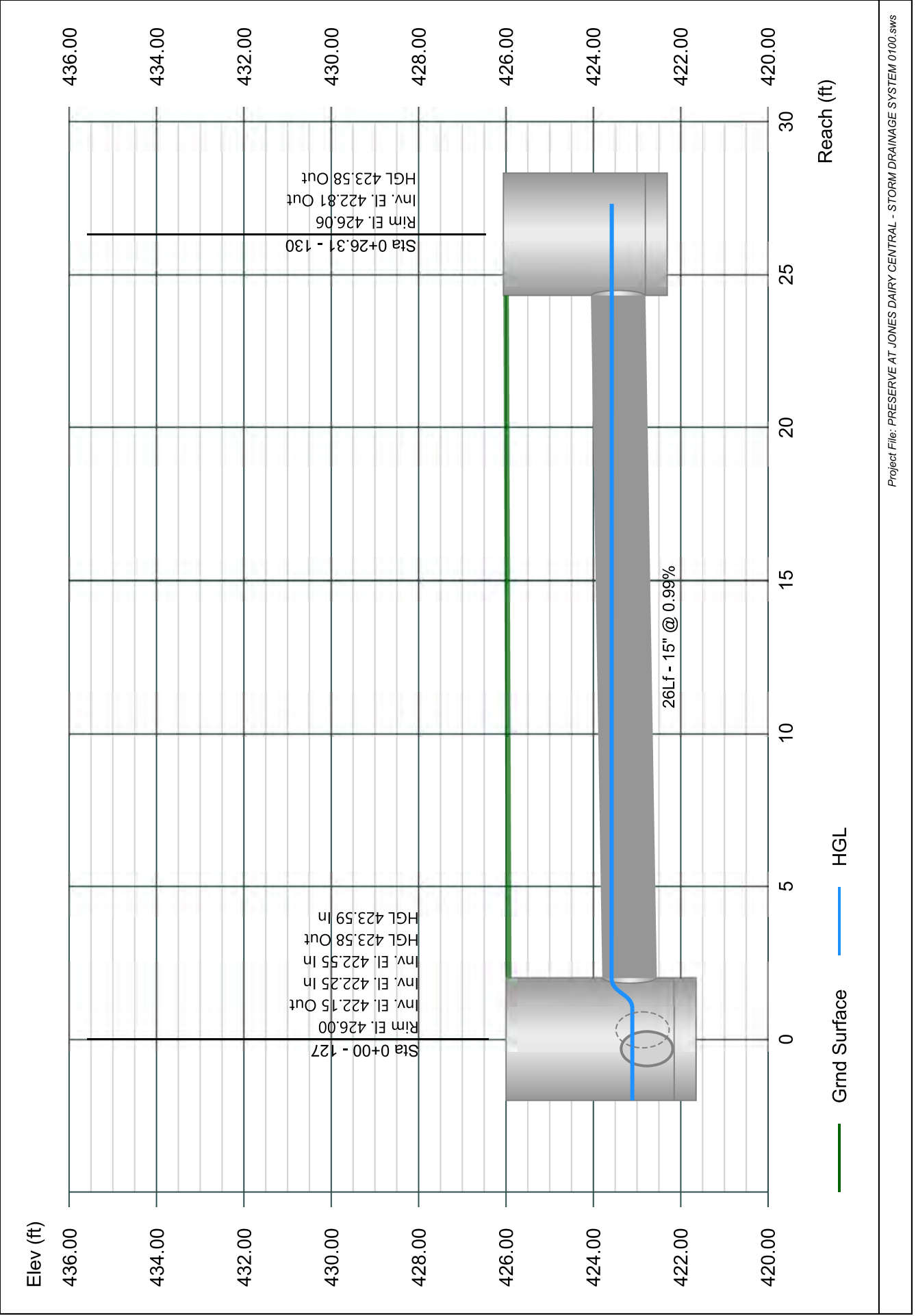

Line 31 - 131 TO 125

Stormwater Studio 2024 v 3.0.0.33

Project Name: Enter Project Name...

01-19-2024

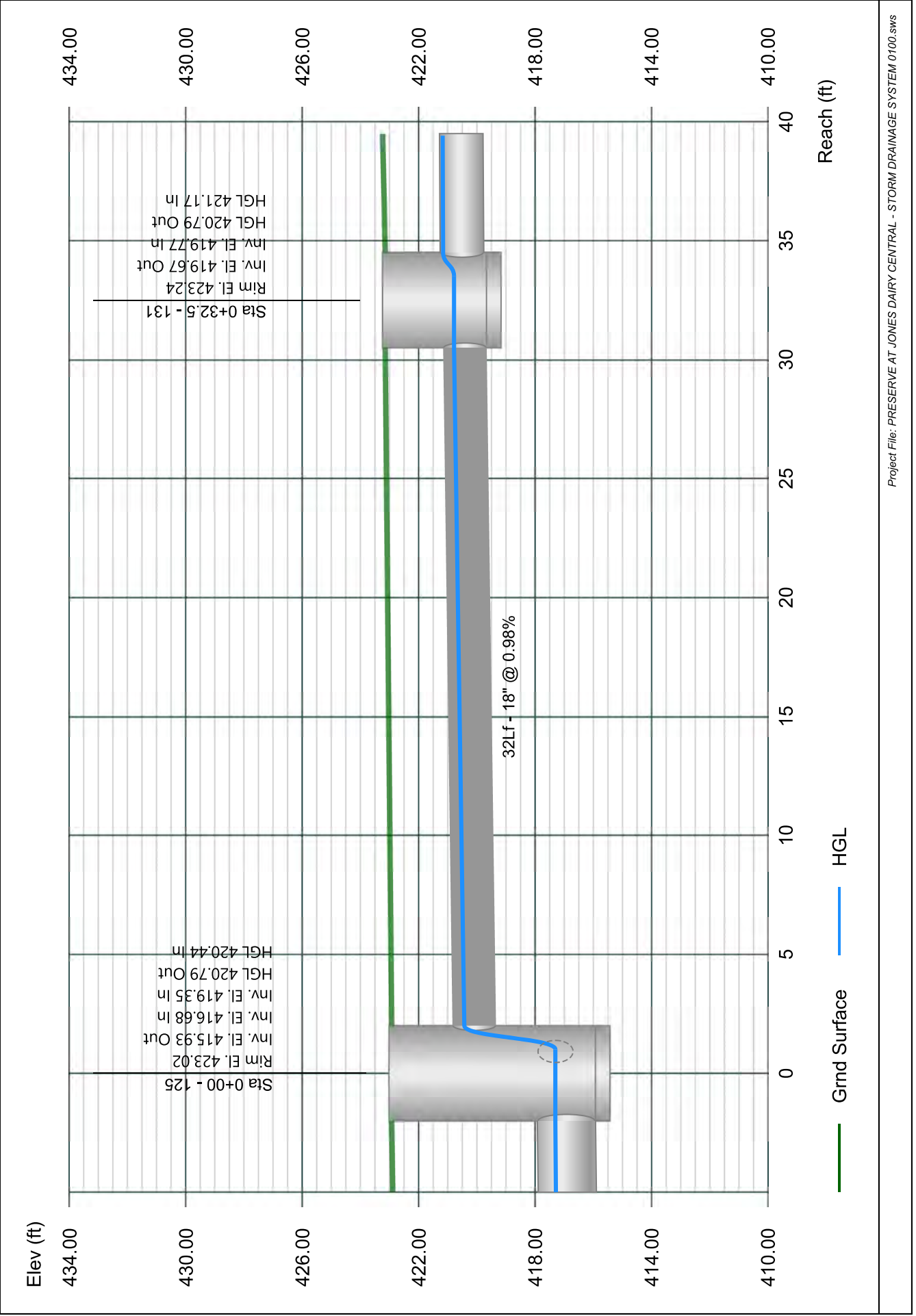

Line 32 - 132 TO 131

Stormwater Studio 2024 v 3.0.0.33

Project Name: Enter Project Name...

01-19-2024

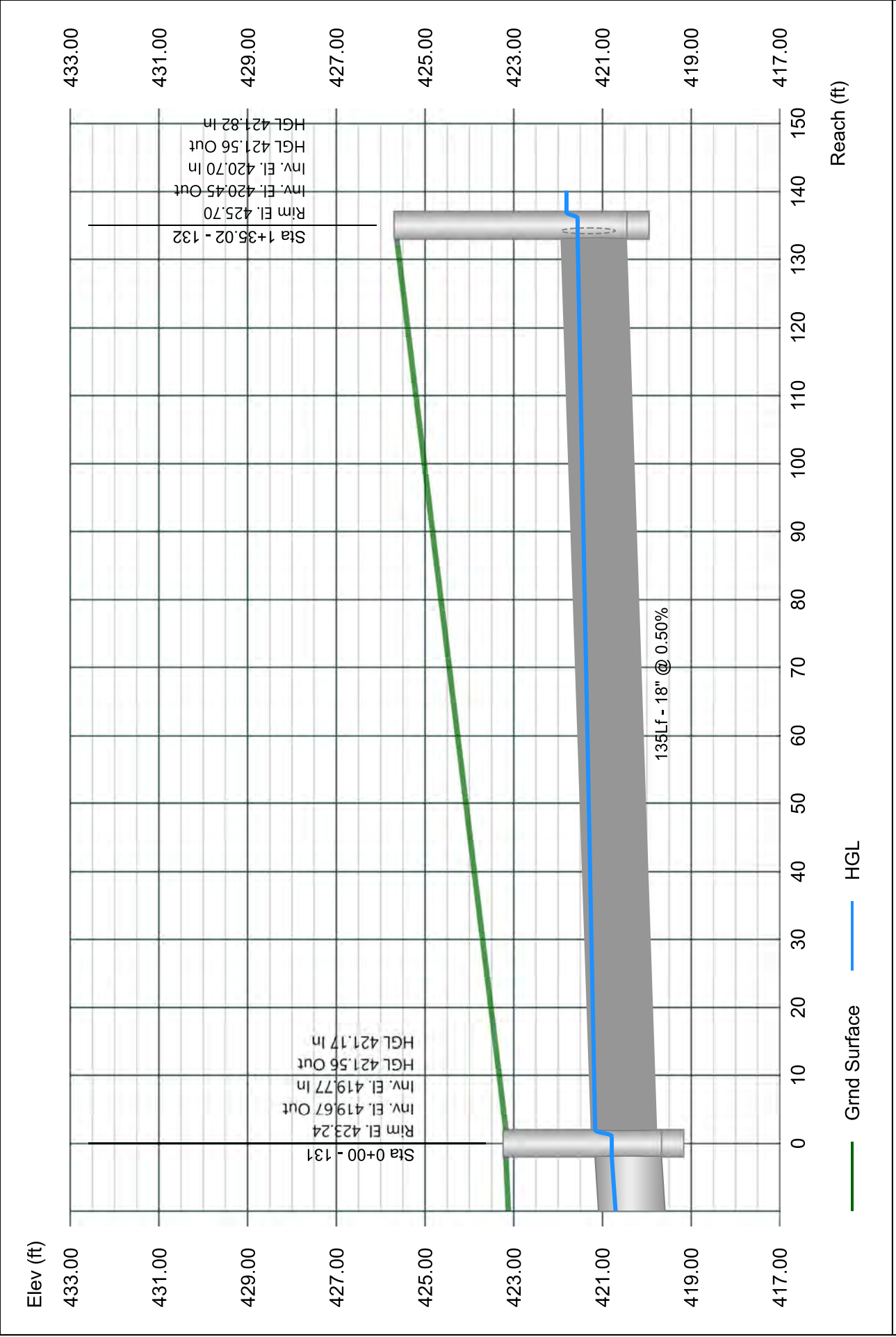

Line 33 - 133 TO 132

Stormwater Studio 2024 v 3.0.0.33

Project Name: Enter Project Name...

01-19-2024

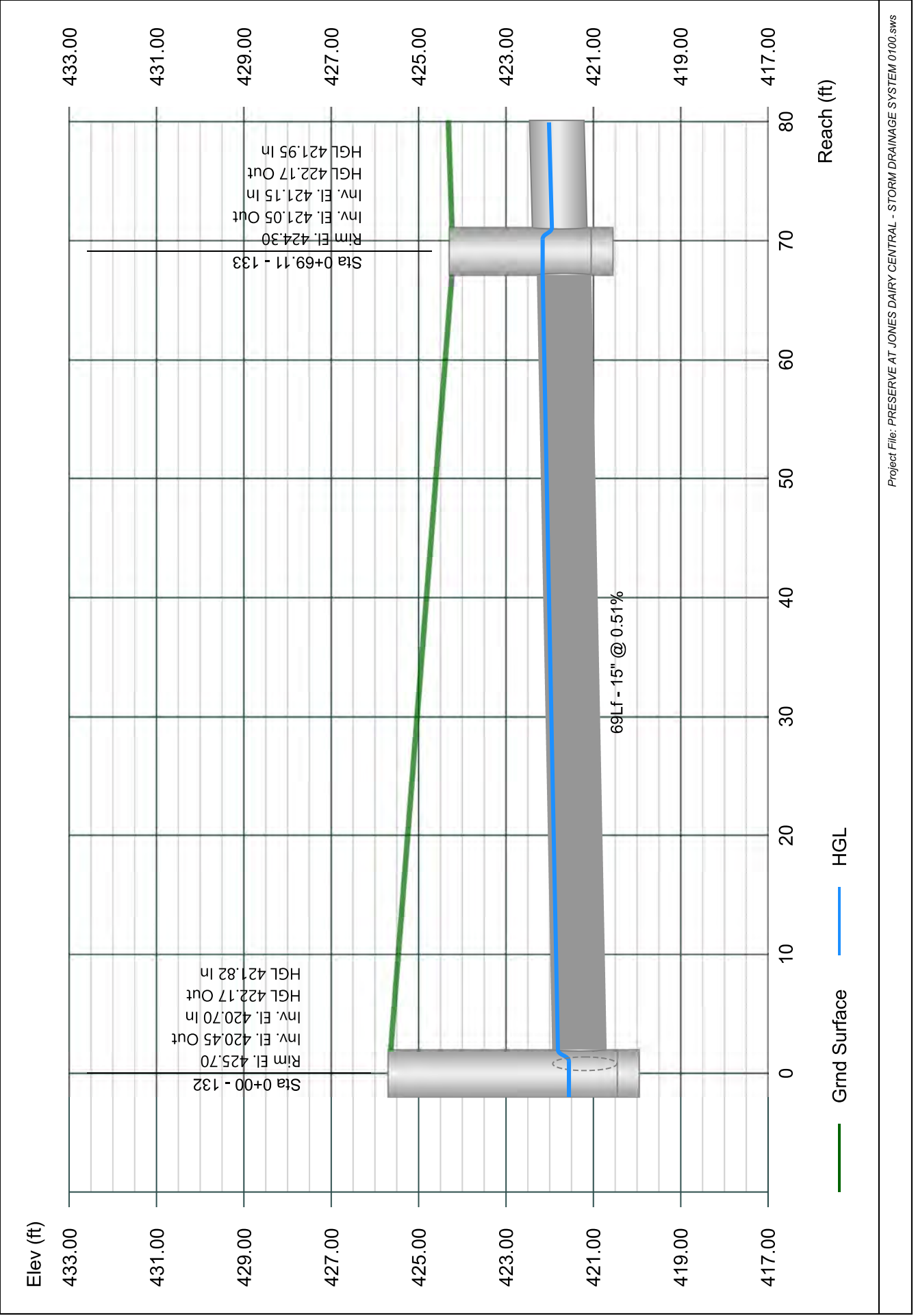

Line 34 - 134 TO 133

Stormwater Studio 2024 v 3.0.0.33

Project Name: Enter Project Name...

01-19-2024

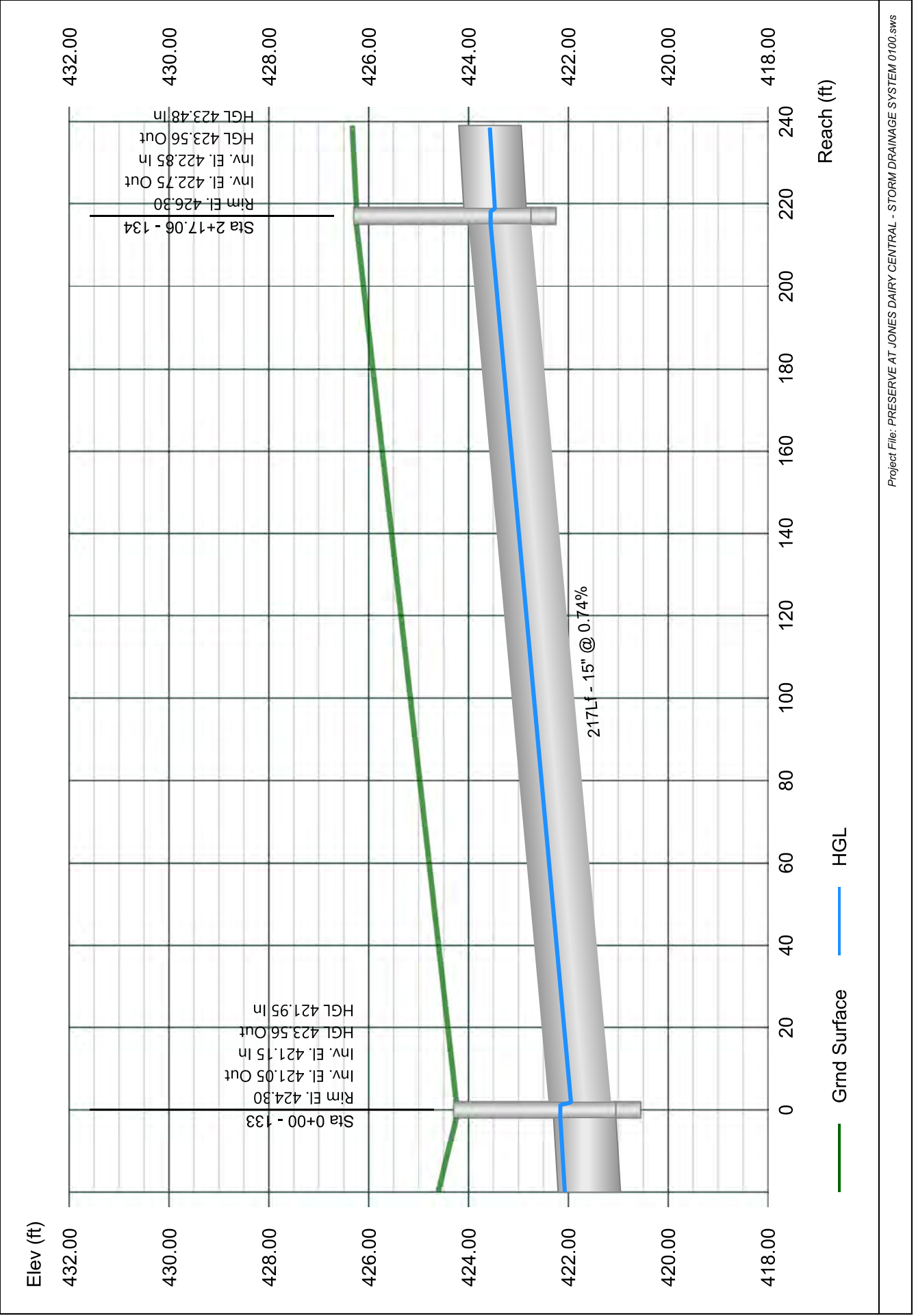

Line 35 - 135 TO 134

Stormwater Studio 2024 v 3.0.0.33

Project Name: Enter Project Name...

01-19-2024

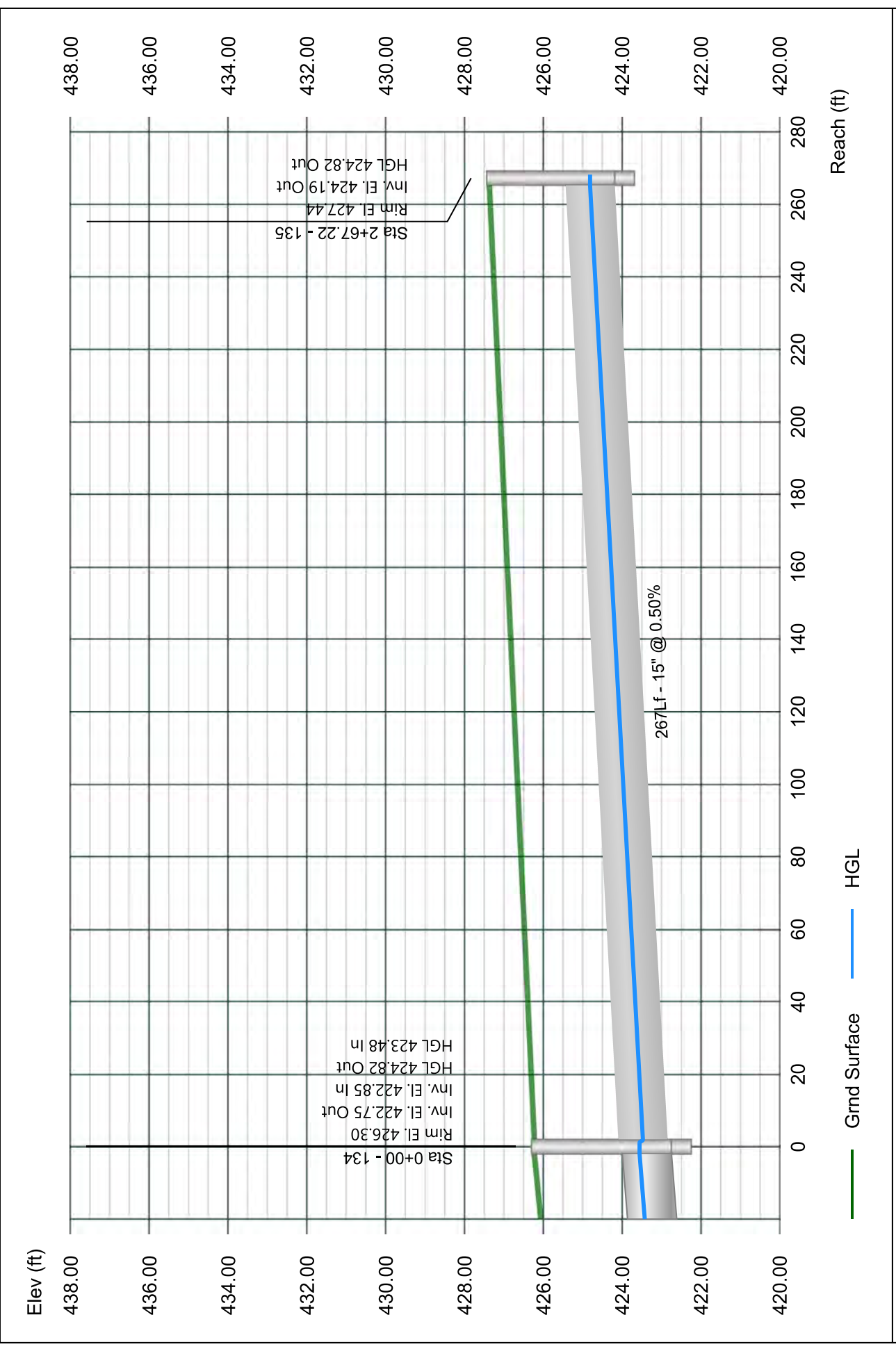

Line 36 - 136 TO 123

Stormwater Studio 2024 v 3.0.0.33

Project Name: Enter Project Name...

01-19-2024

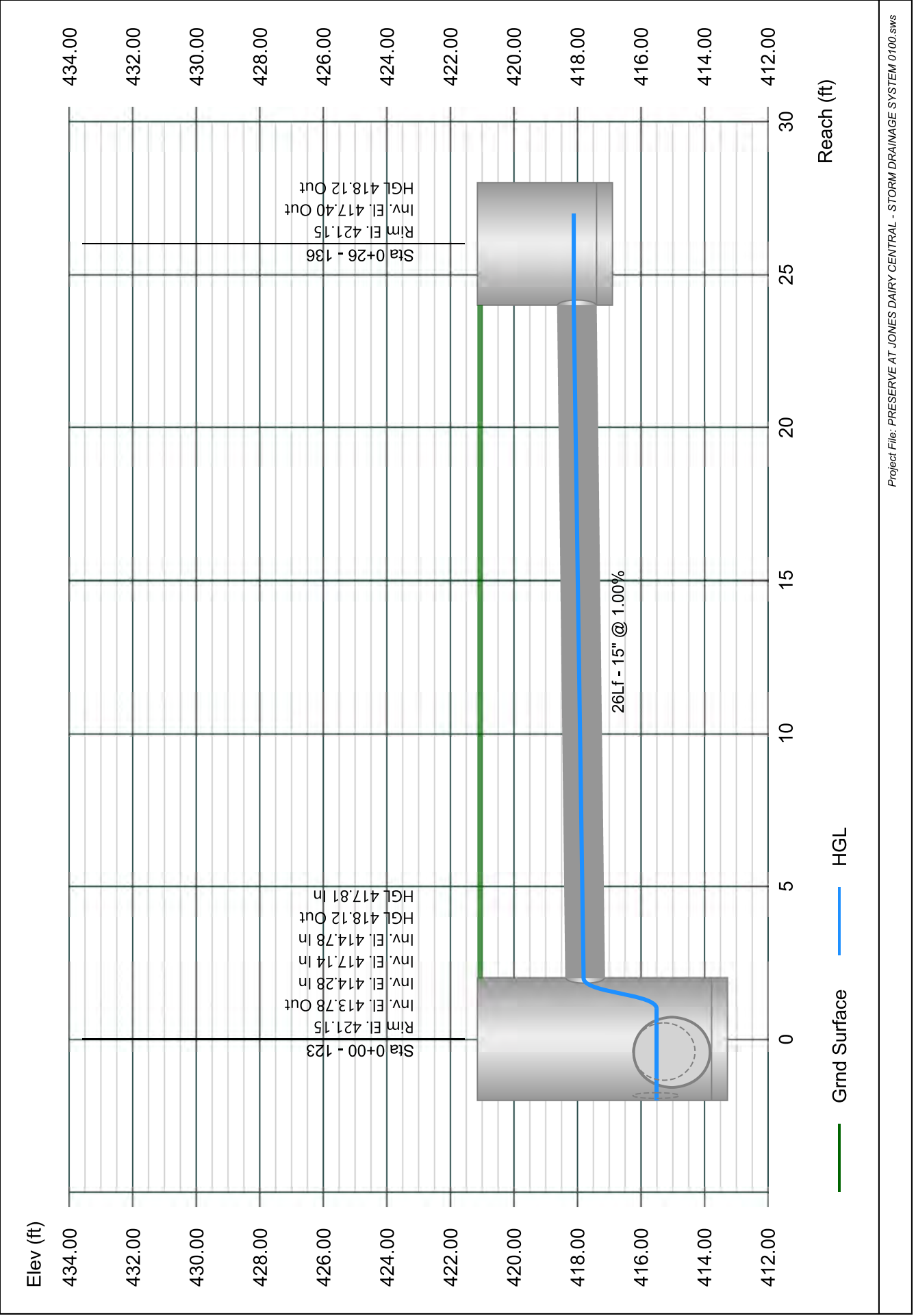

Line 37 - 137 TO 123

Stormwater Studio 2024 v 3.0.0.33

Project Name: Enter Project Name...

01-19-2024

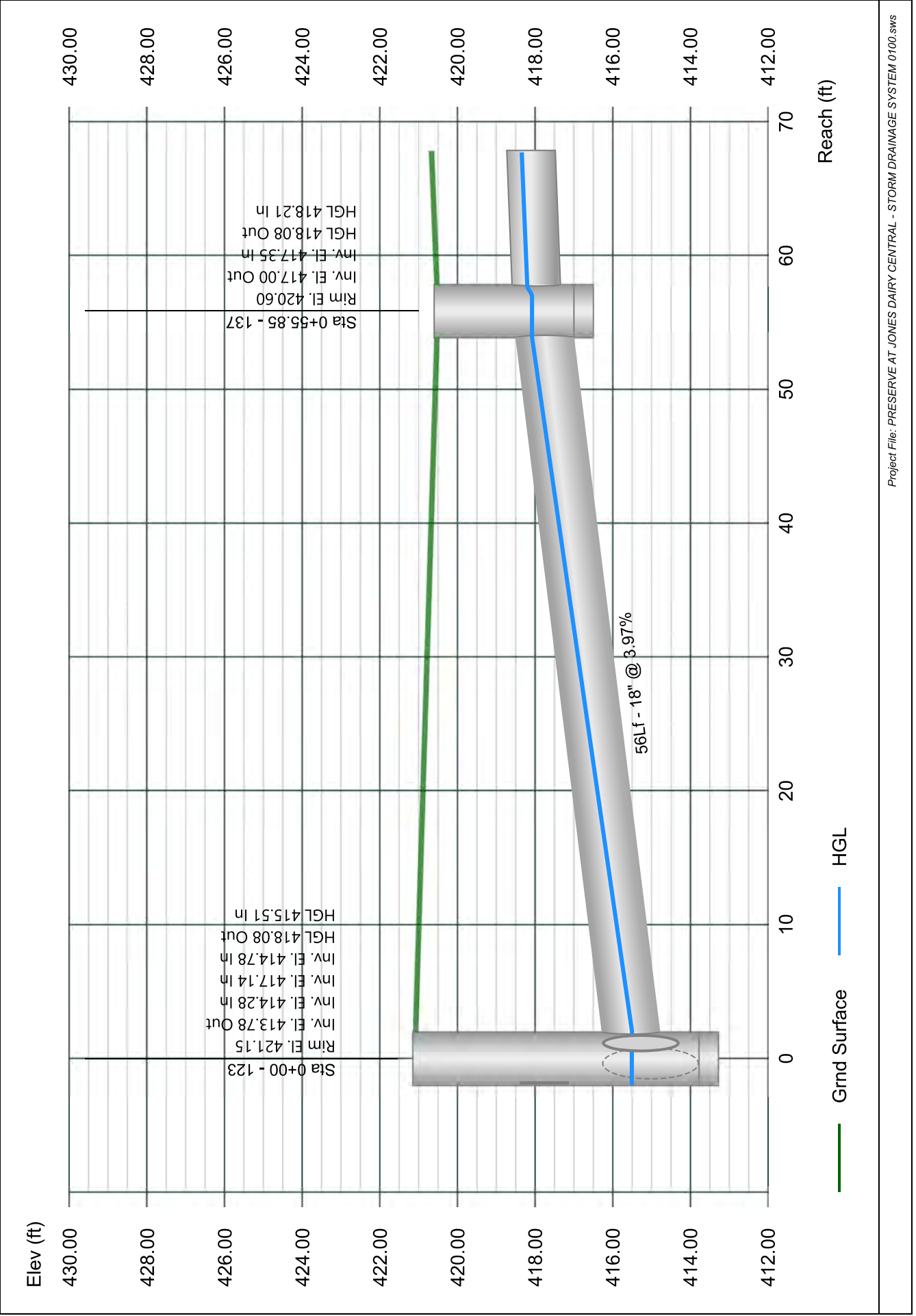

Line 38 - 138 TO 137

Stormwater Studio 2024 v 3.0.0.33

Project Name: Enter Project Name...

01-19-2024

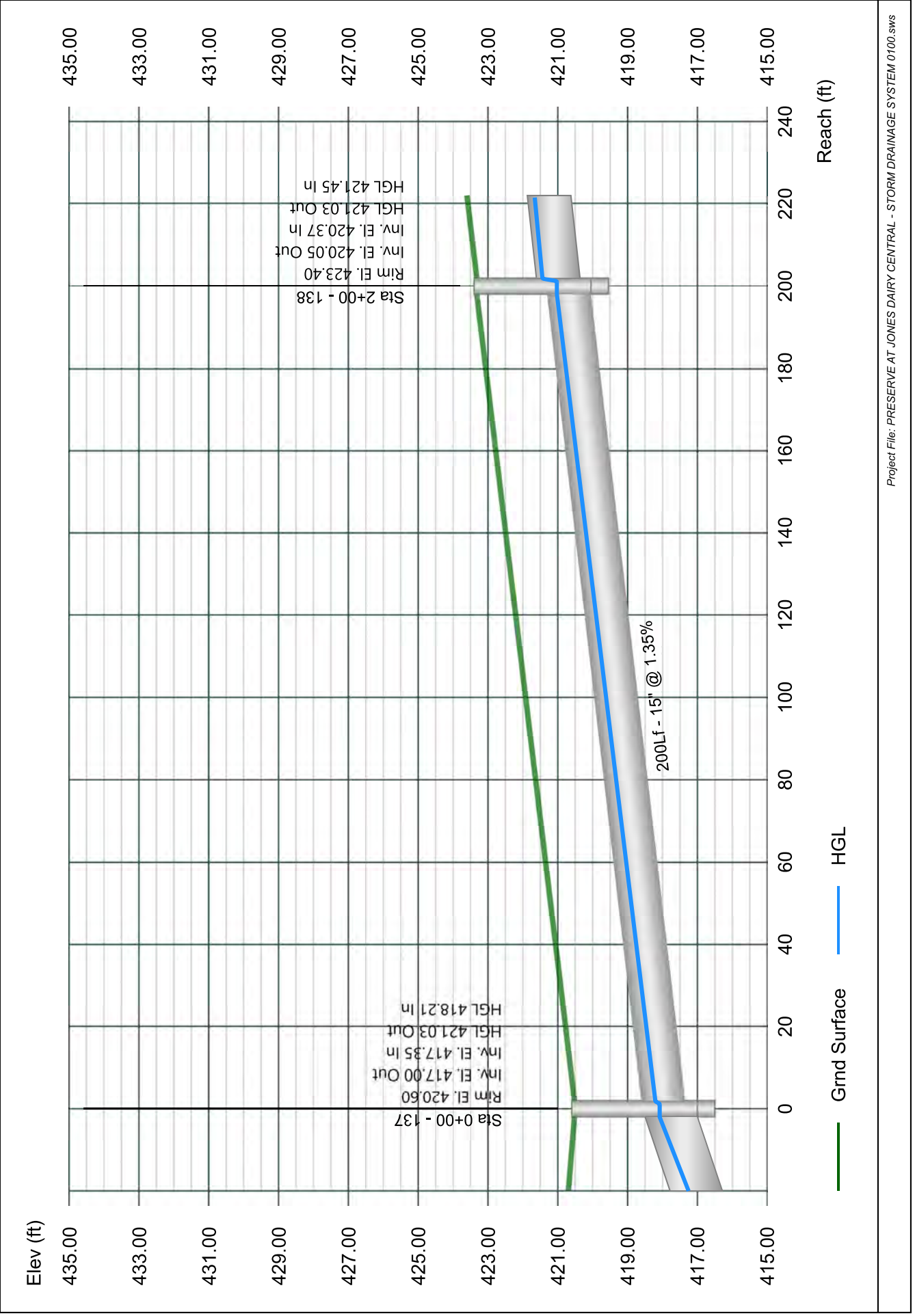

Line 39 - 139 TO 138

Stormwater Studio 2024 v 3.0.0.33

Project Name: Enter Project Name...

01-19-2024

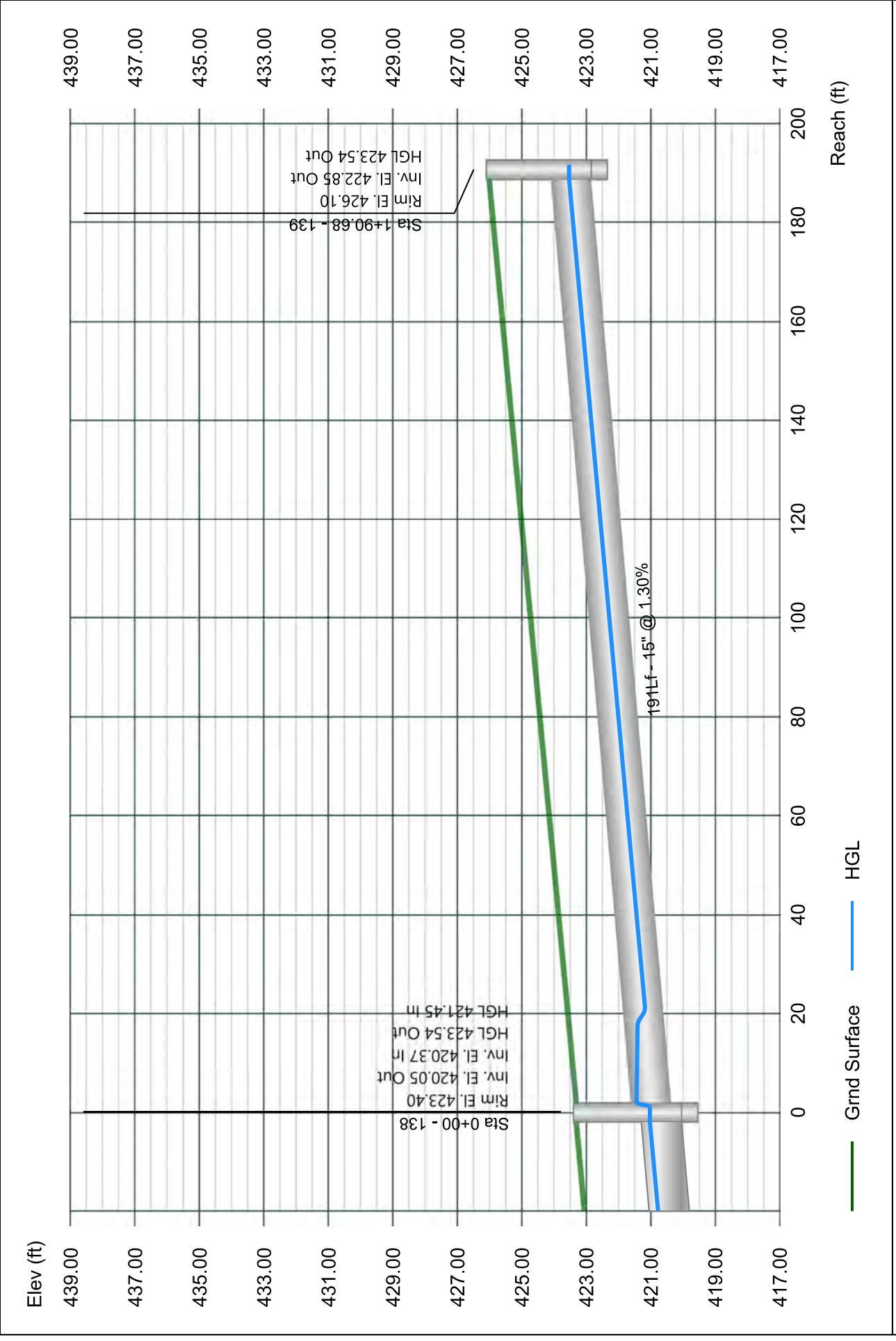

Line 40 - 140 TO 122

Stormwater Studio 2024 v 3.0.0.33

Project Name: Enter Project Name...

01-19-2024

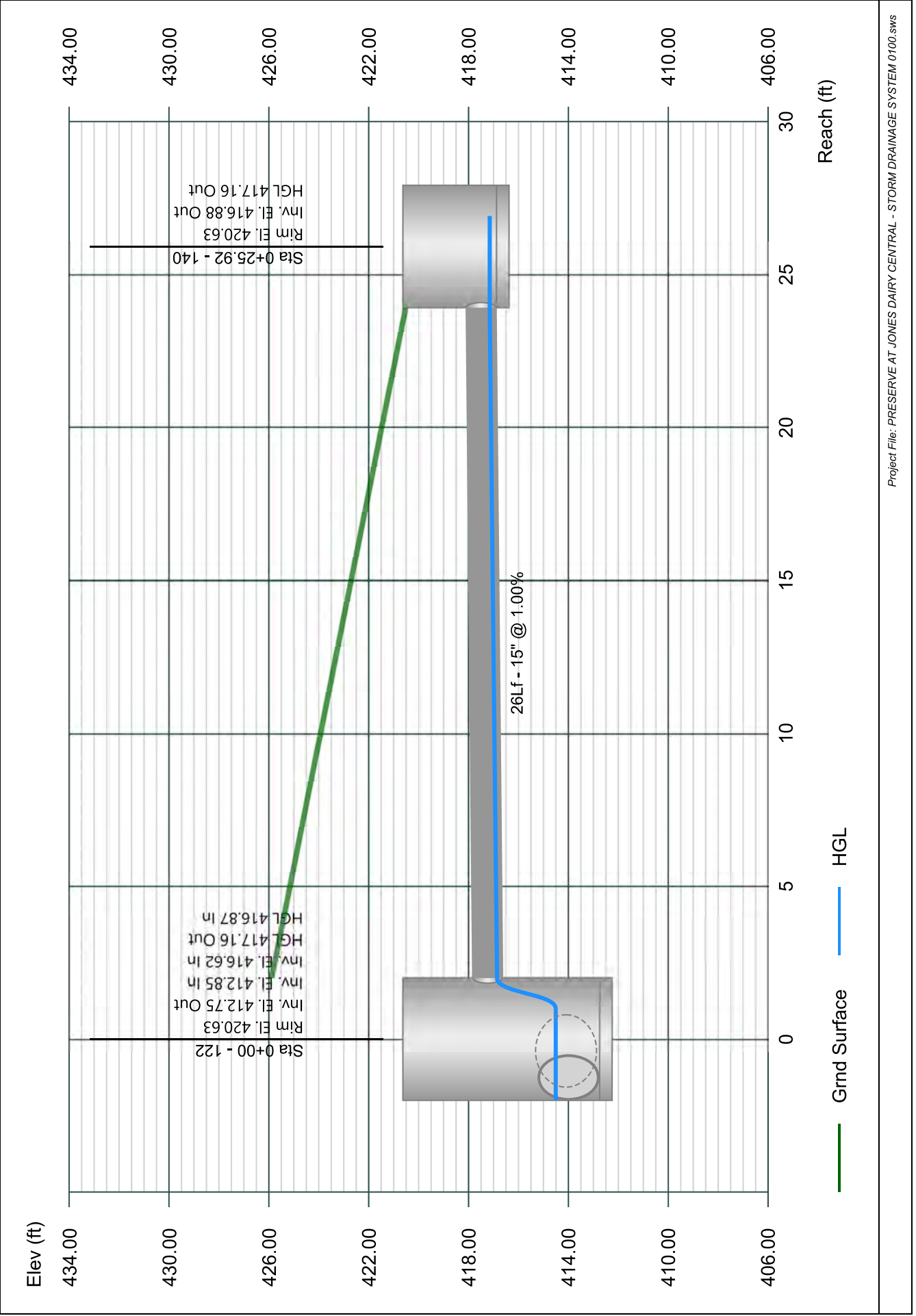

Line 41 - 141 TO 120

Stormwater Studio 2024 v 3.0.0.33

Project Name: Enter Project Name...

01-19-2024

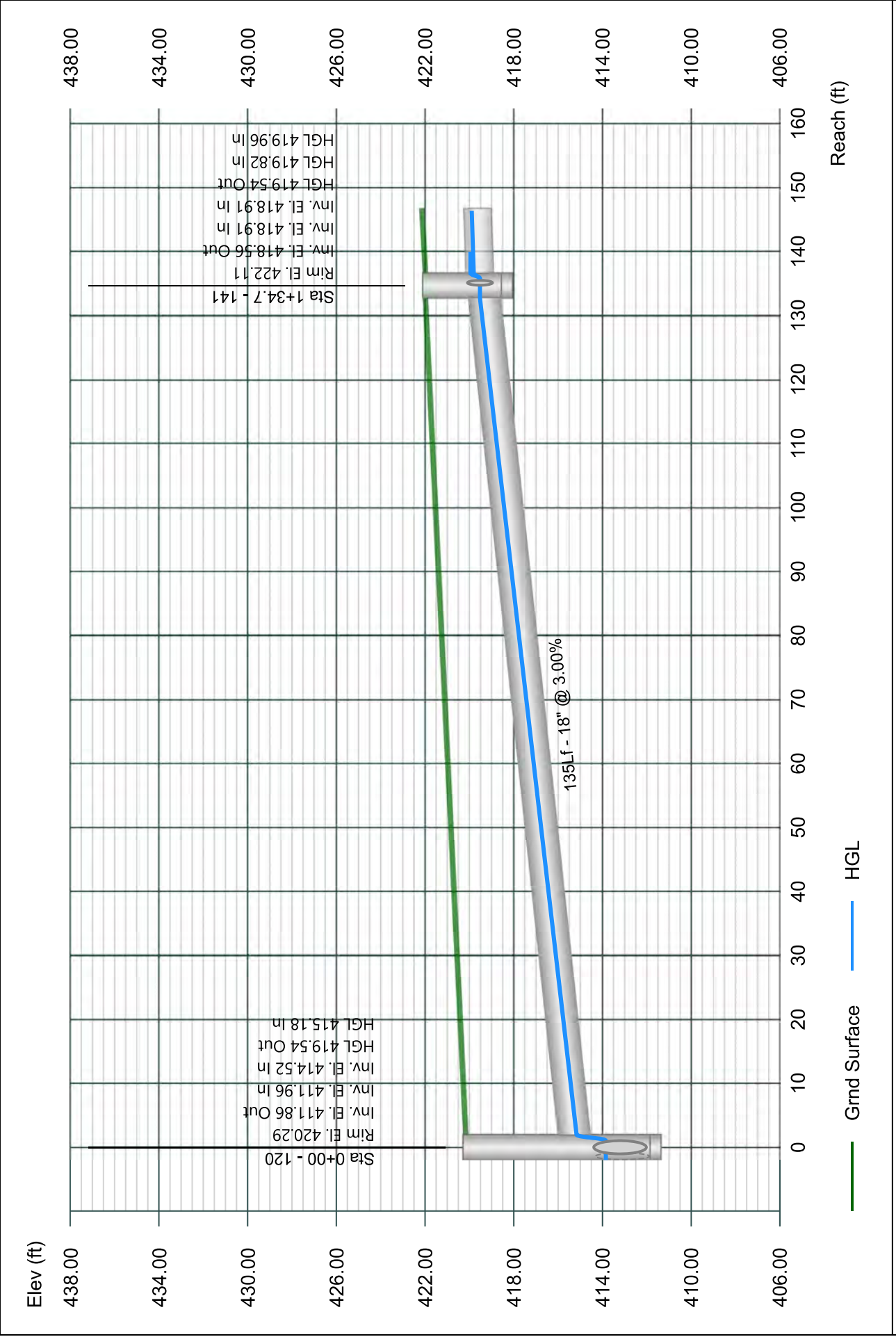

Line 42 - 142 TO 141

Stormwater Studio 2024 v 3.0.0.33

Project Name: Enter Project Name...

01-19-2024

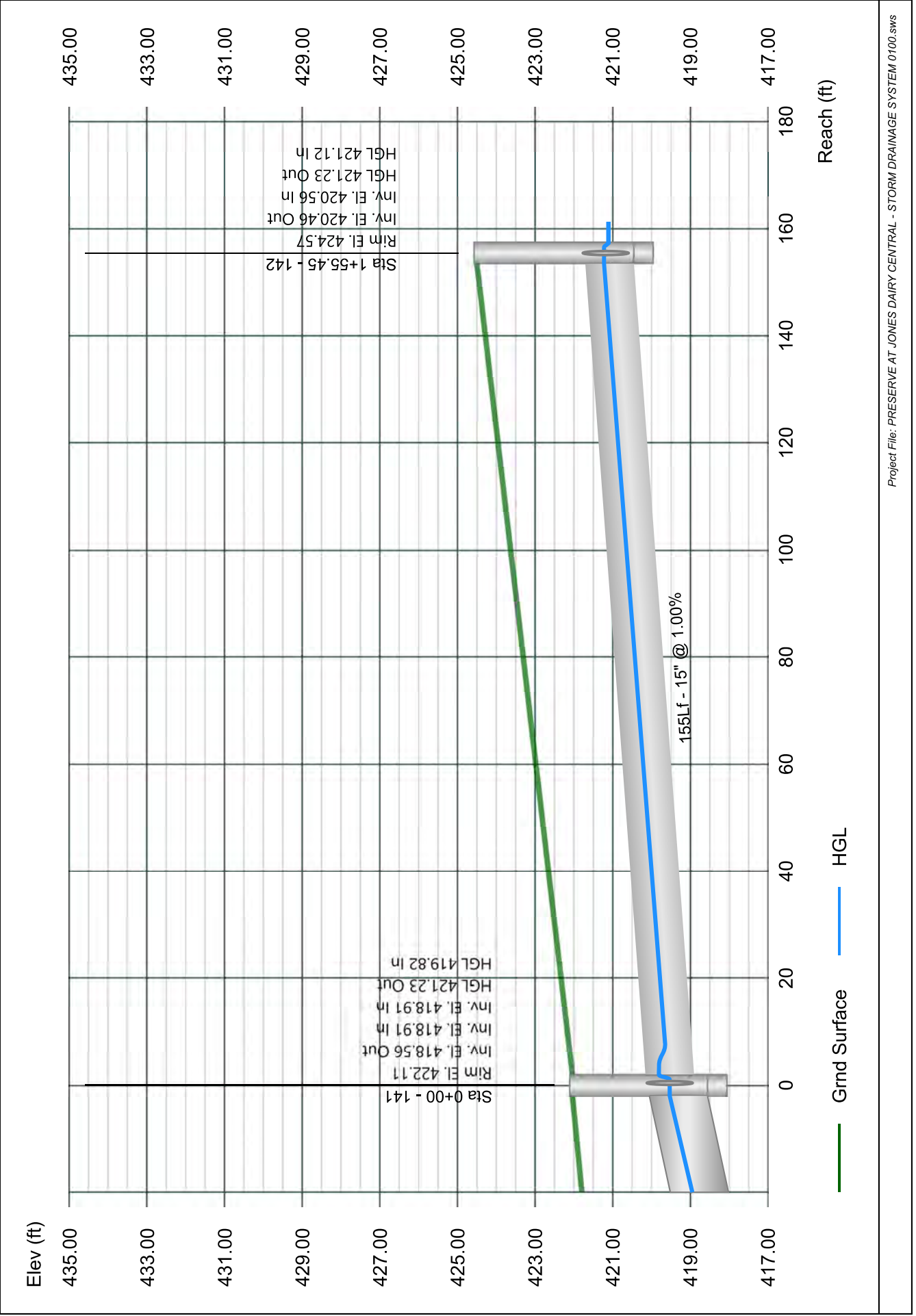

Line 43 - 143 TO 142

Stormwater Studio 2024 v 3.0.0.33

Project Name: Enter Project Name...

01-19-2024

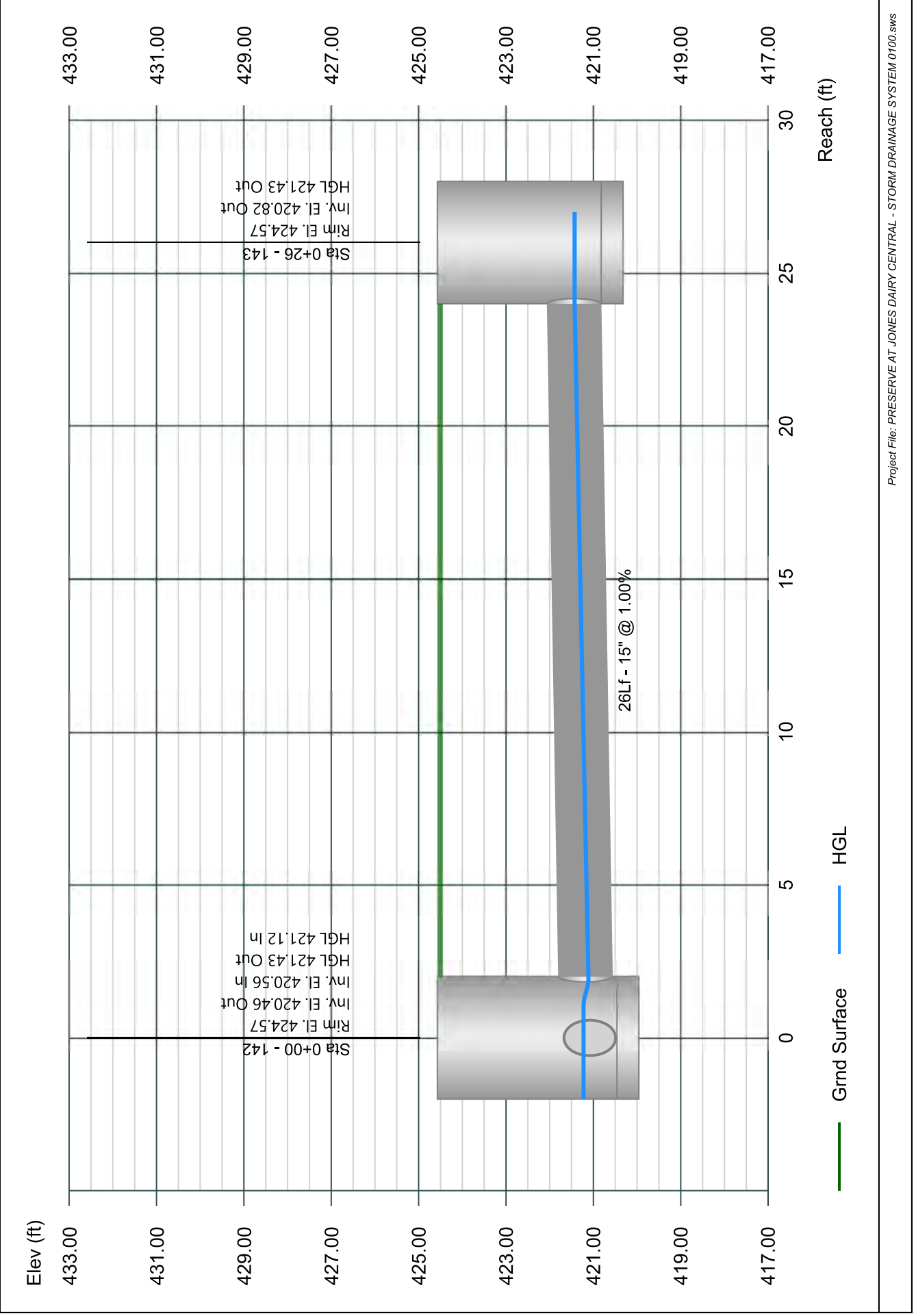

Line 44 - 144 TO 141

Stormwater Studio 2024 v 3.0.0.33

Project Name: Enter Project Name...

01-19-2024

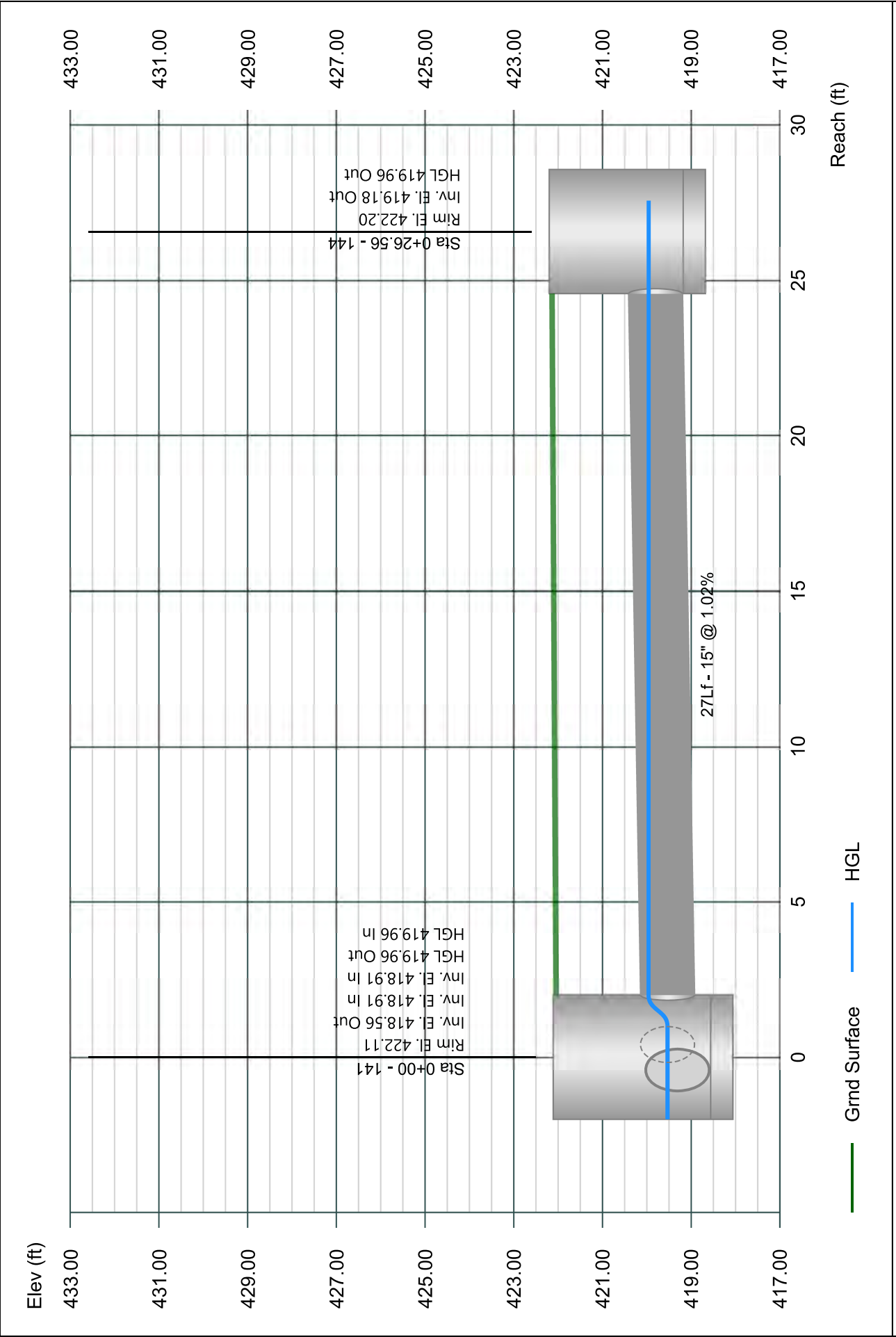

Line 45 - 145 to 117

Stormwater Studio 2024 v 3.0.0.33

Project Name: Enter Project Name...

01-19-2024

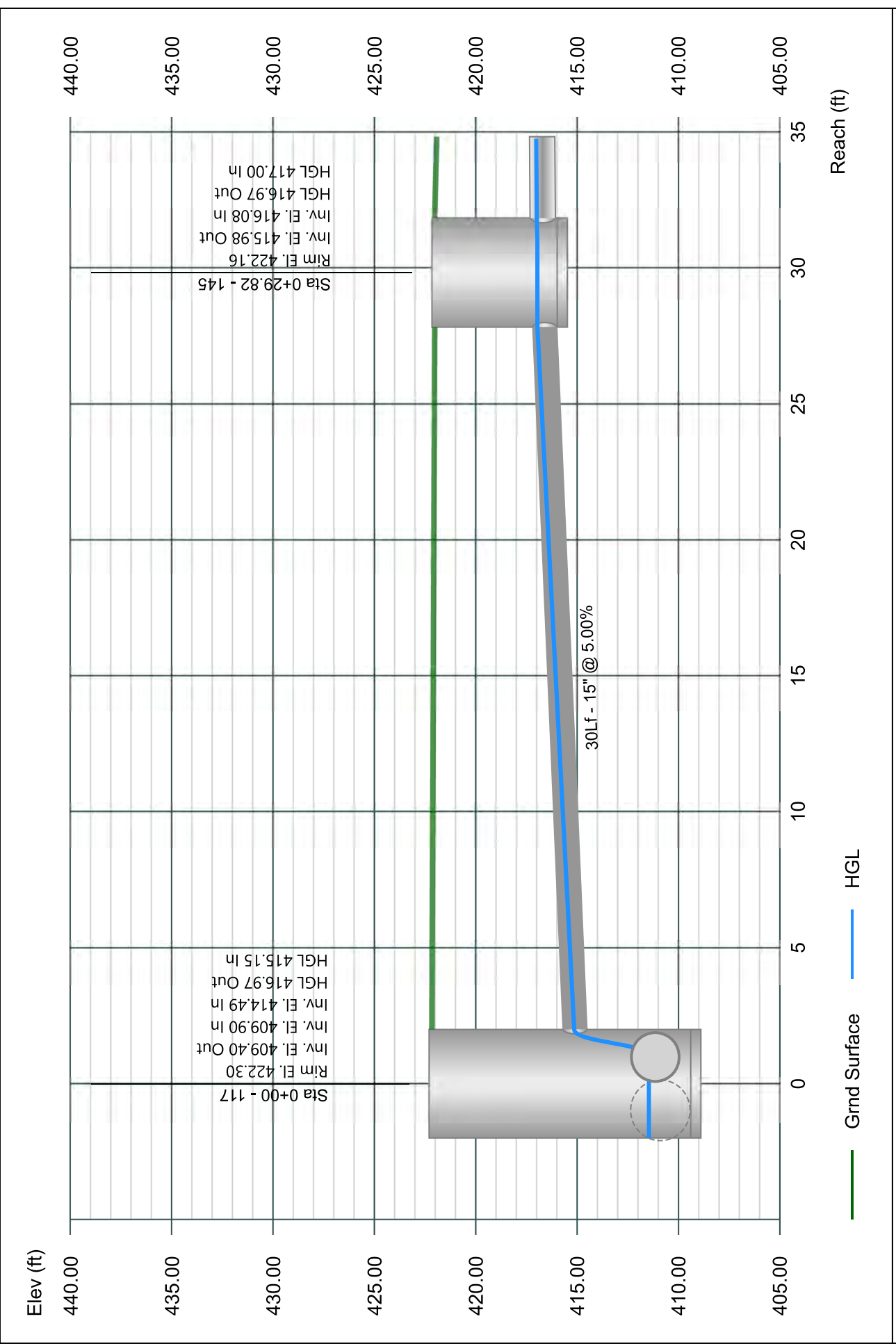

Line 46 - 146 to 145

Stormwater Studio 2024 v 3.0.0.33

Project Name: Enter Project Name...

01-19-2024

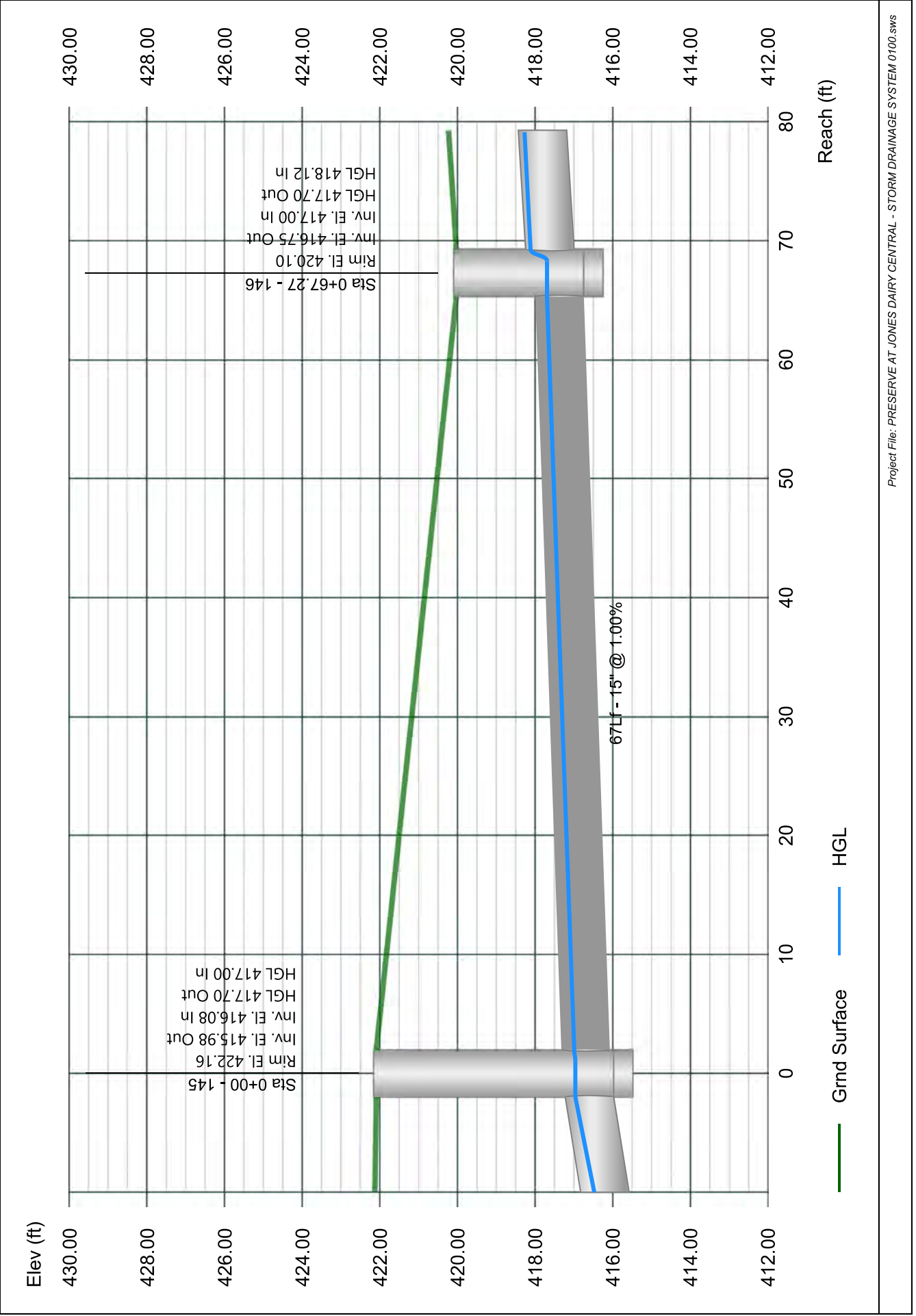

Line 47 - 147 to 146

Stormwater Studio 2024 v 3.0.0.33

Project Name: Enter Project Name...

01-19-2024

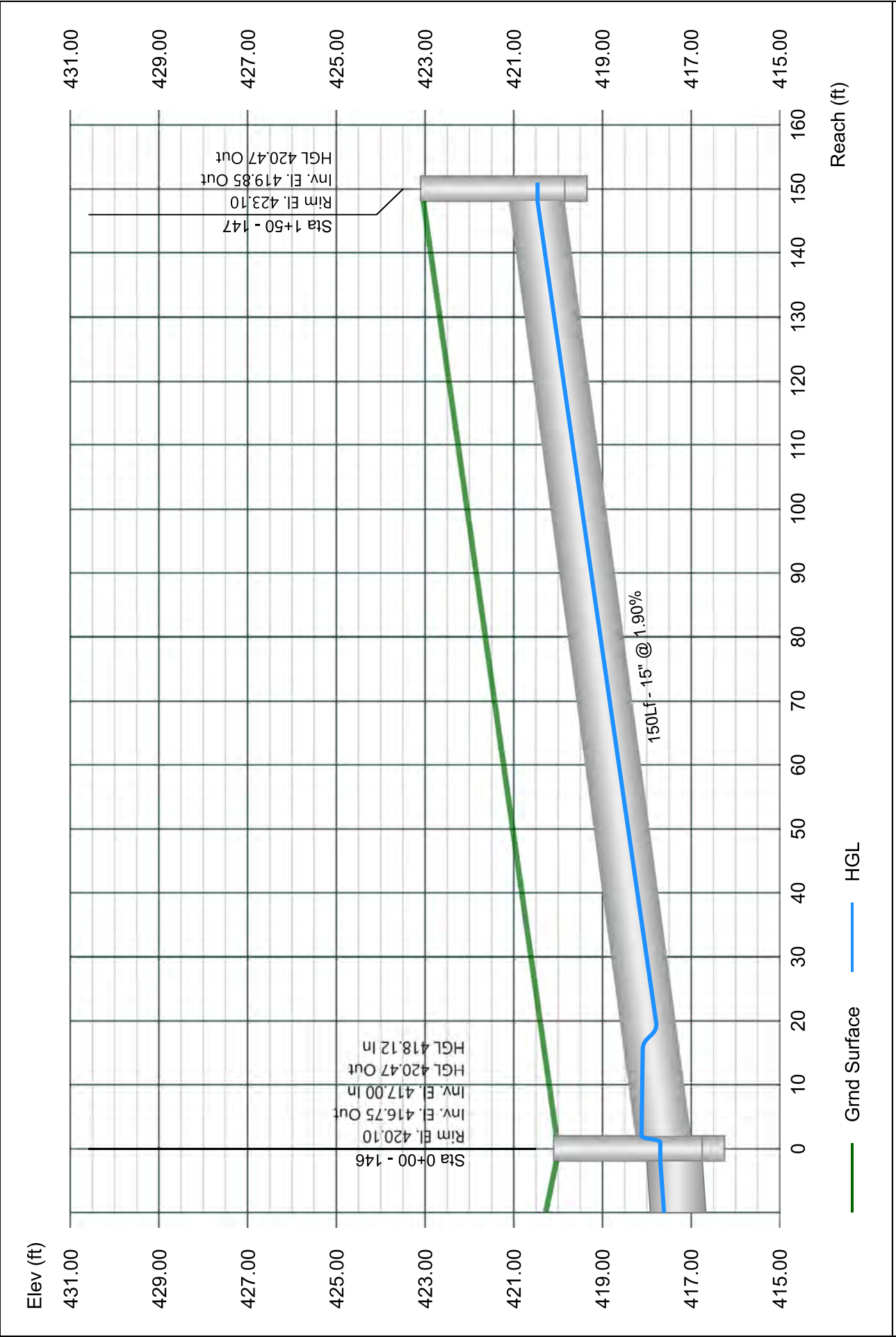

Line 48 - 148 TO 114

Stormwater Studio 2024 v 3.0.0.33

Project Name: Enter Project Name...

01-19-2024

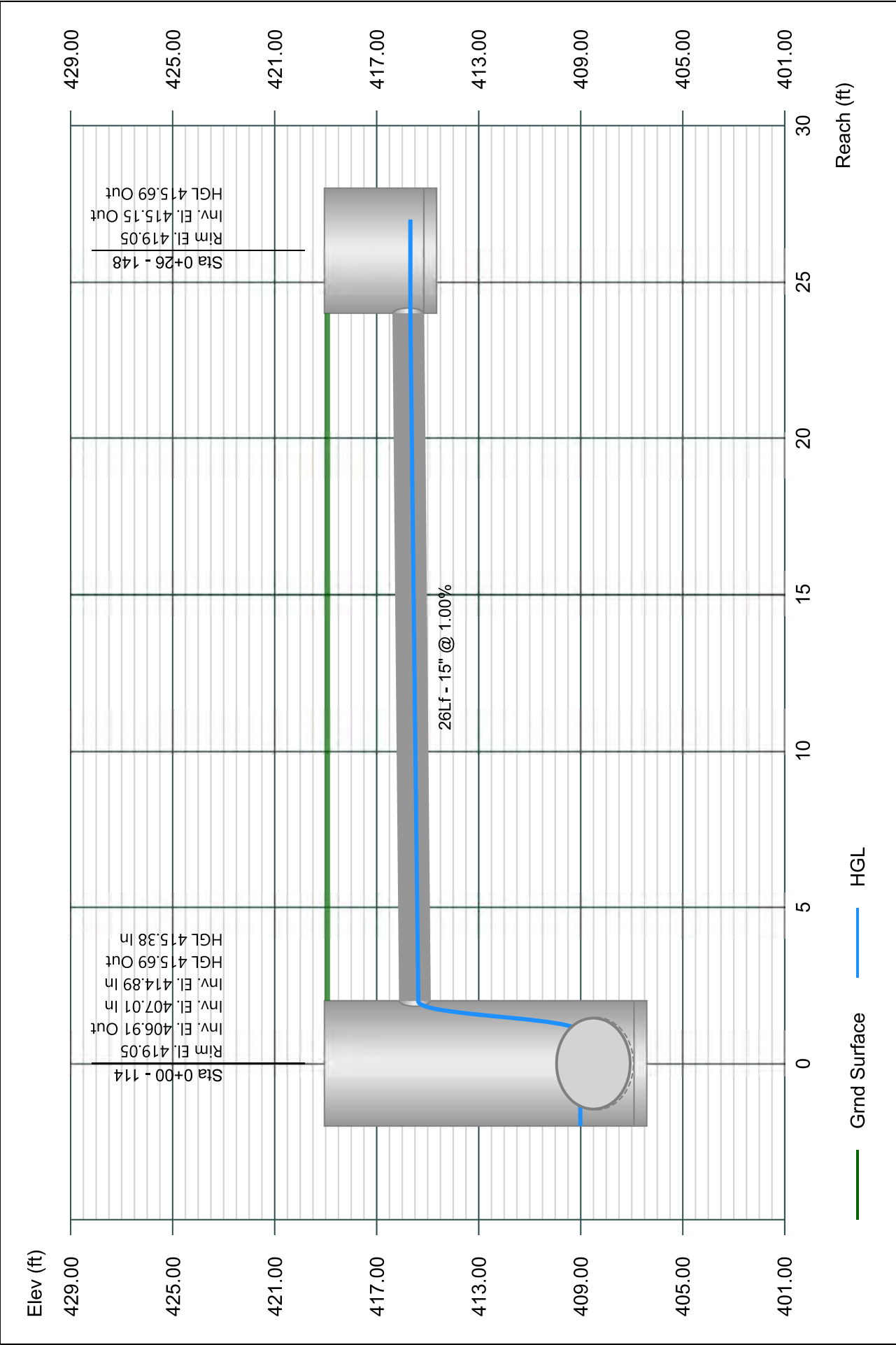

Line 49 - 149 TO 107

Stormwater Studio 2024 v 3.0.0.33

Project Name: Enter Project Name...

01-19-2024

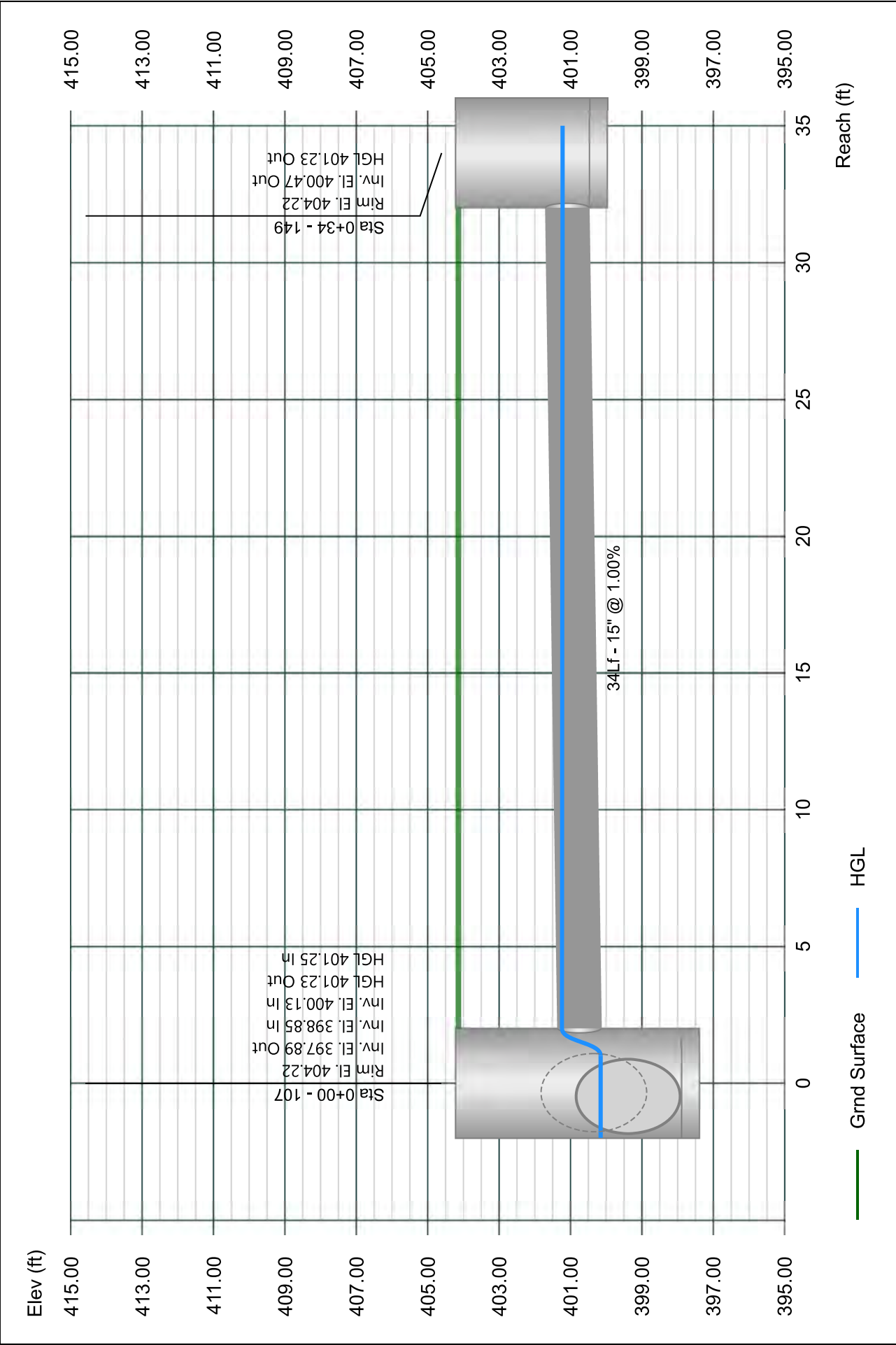

Line 50 - 150 TO 103

Stormwater Studio 2024 v 3.0.0.33

Project Name: Enter Project Name...

01-19-2024

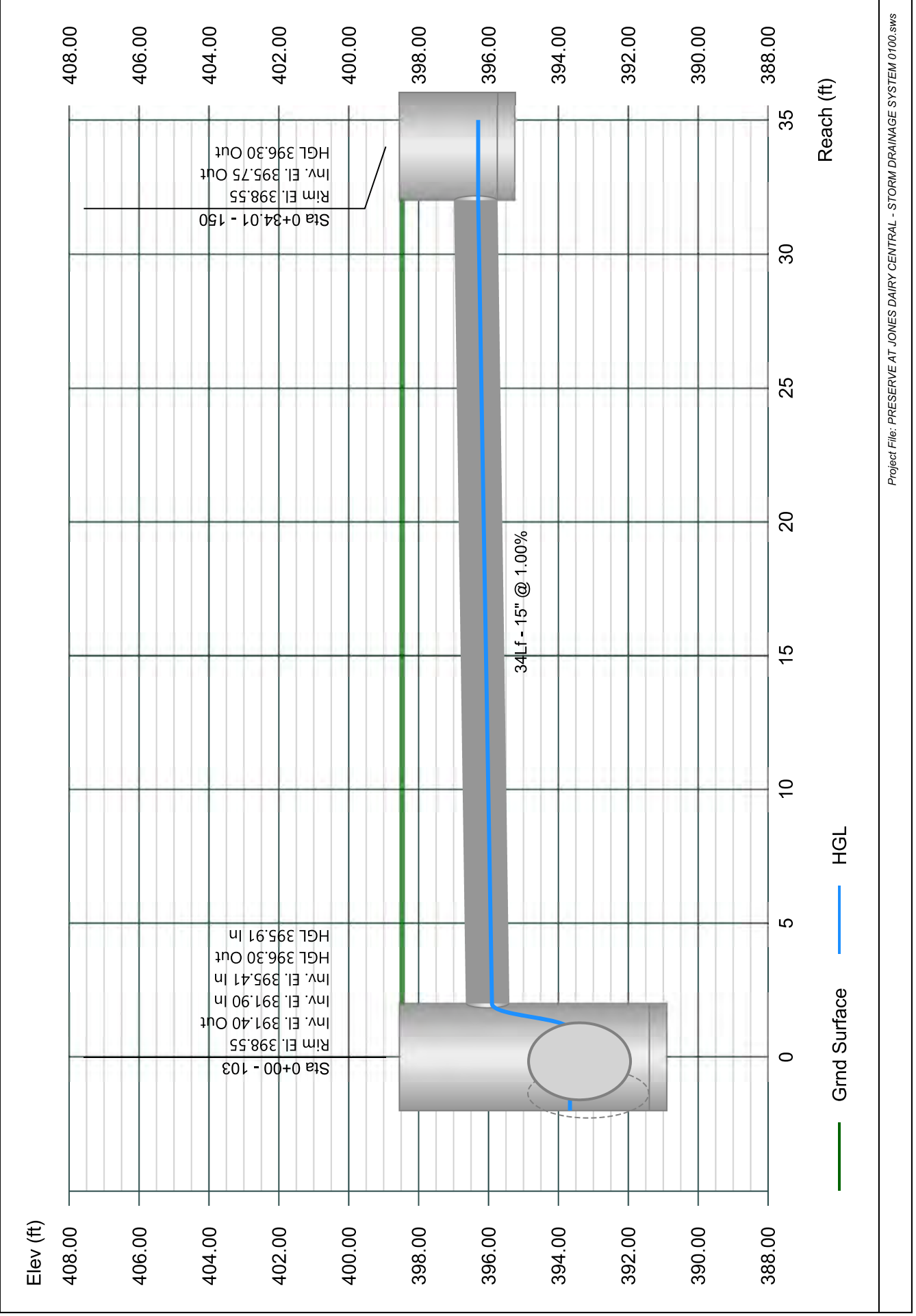

Line 51 - 151 TO 102

Stormwater Studio 2024 v 3.0.0.33

Project Name: Enter Project Name...

01-19-2024

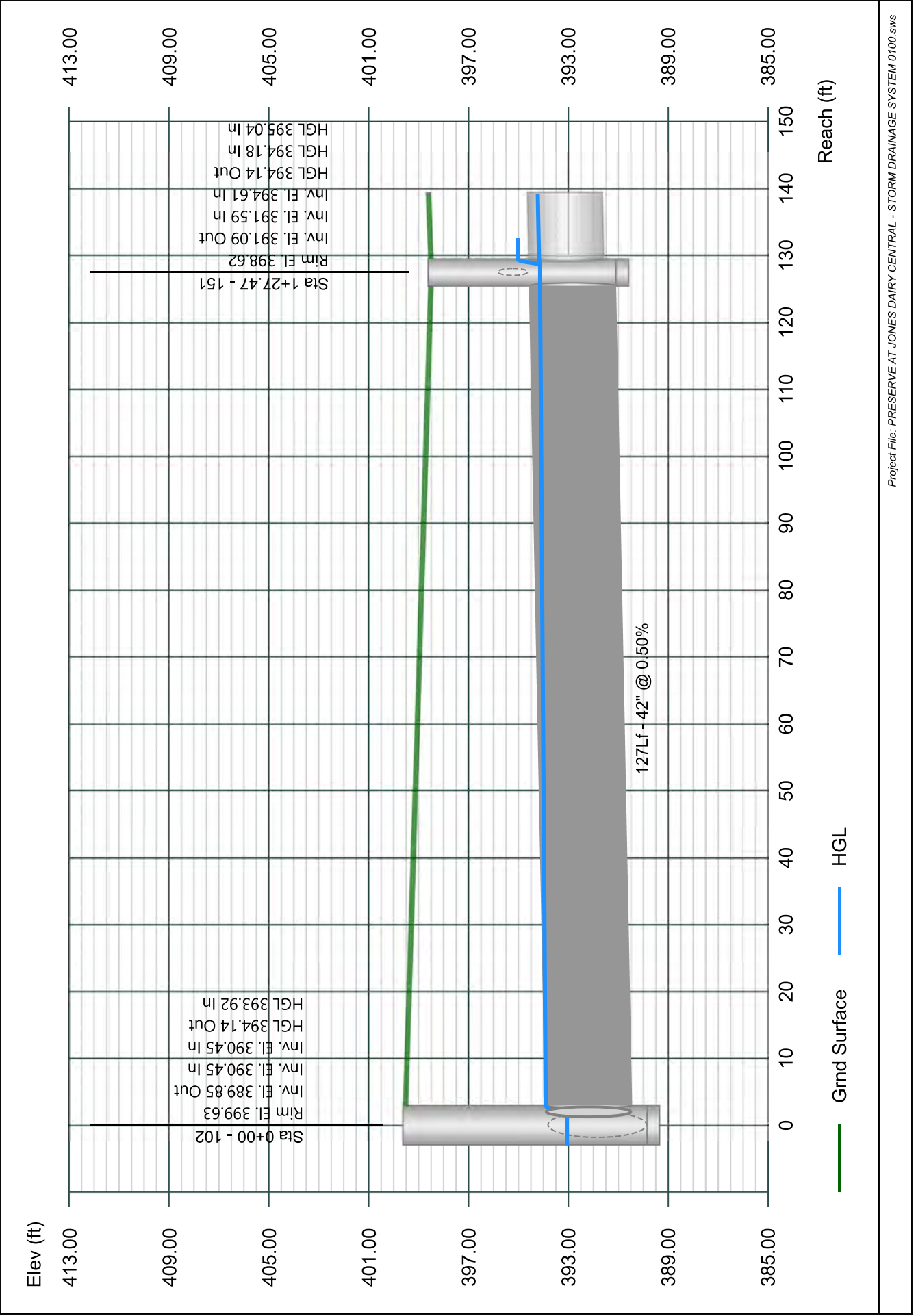

Line 52 - 152 TO 151

Stormwater Studio 2024 v 3.0.0.33

Project Name: Enter Project Name...

01-19-2024

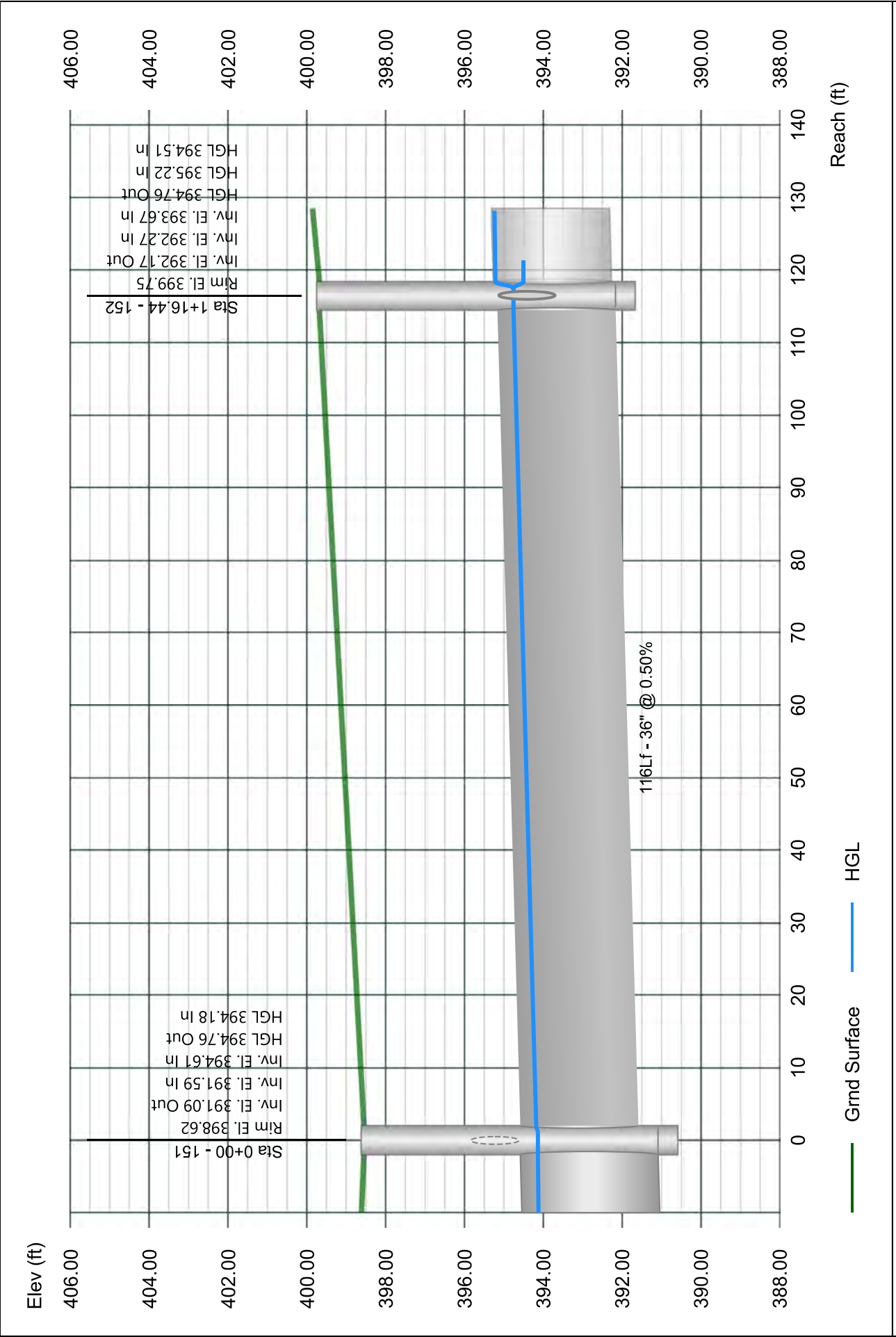

Line 53 - 153 TO 152

Stormwater Studio 2024 v 3.0.0.33

Project Name: Enter Project Name...

01-19-2024

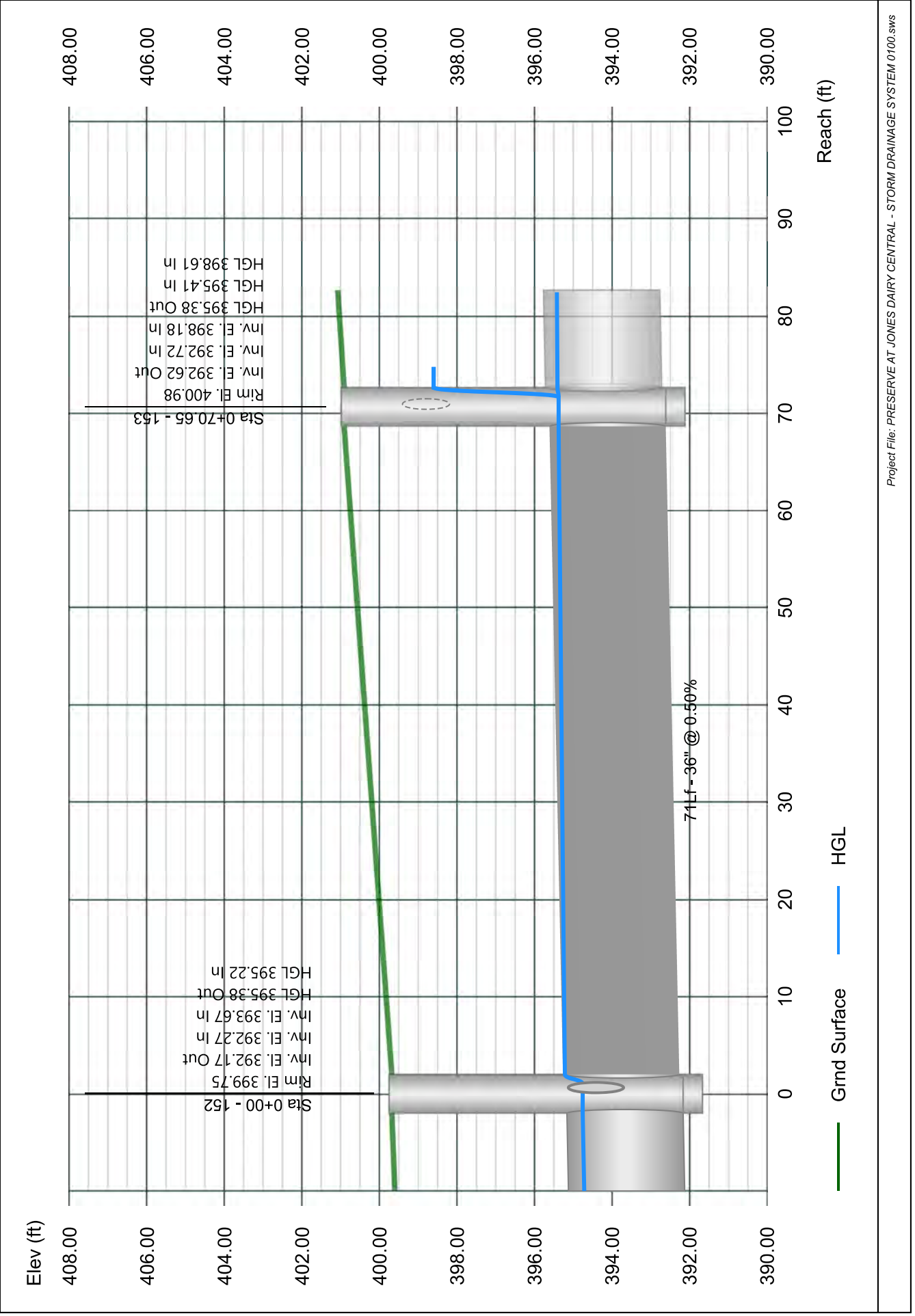

Line 54 - 154 TO 153

Stormwater Studio 2024 v 3.0.0.33

Project Name: Enter Project Name...

01-19-2024

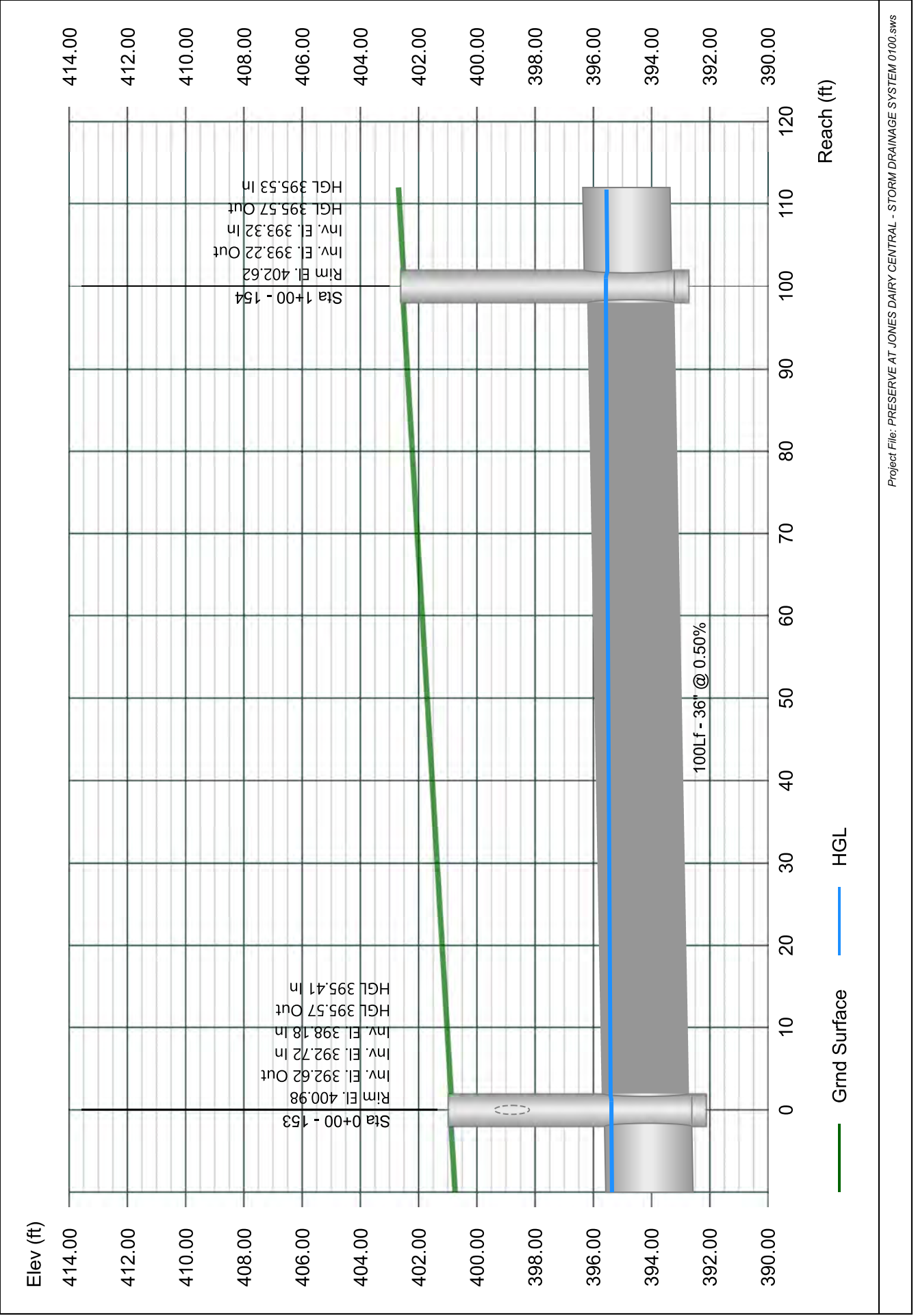

Line 55 - 155 TO 154

Stormwater Studio 2024 v 3.0.0.33

Project Name: Enter Project Name...

01-19-2024

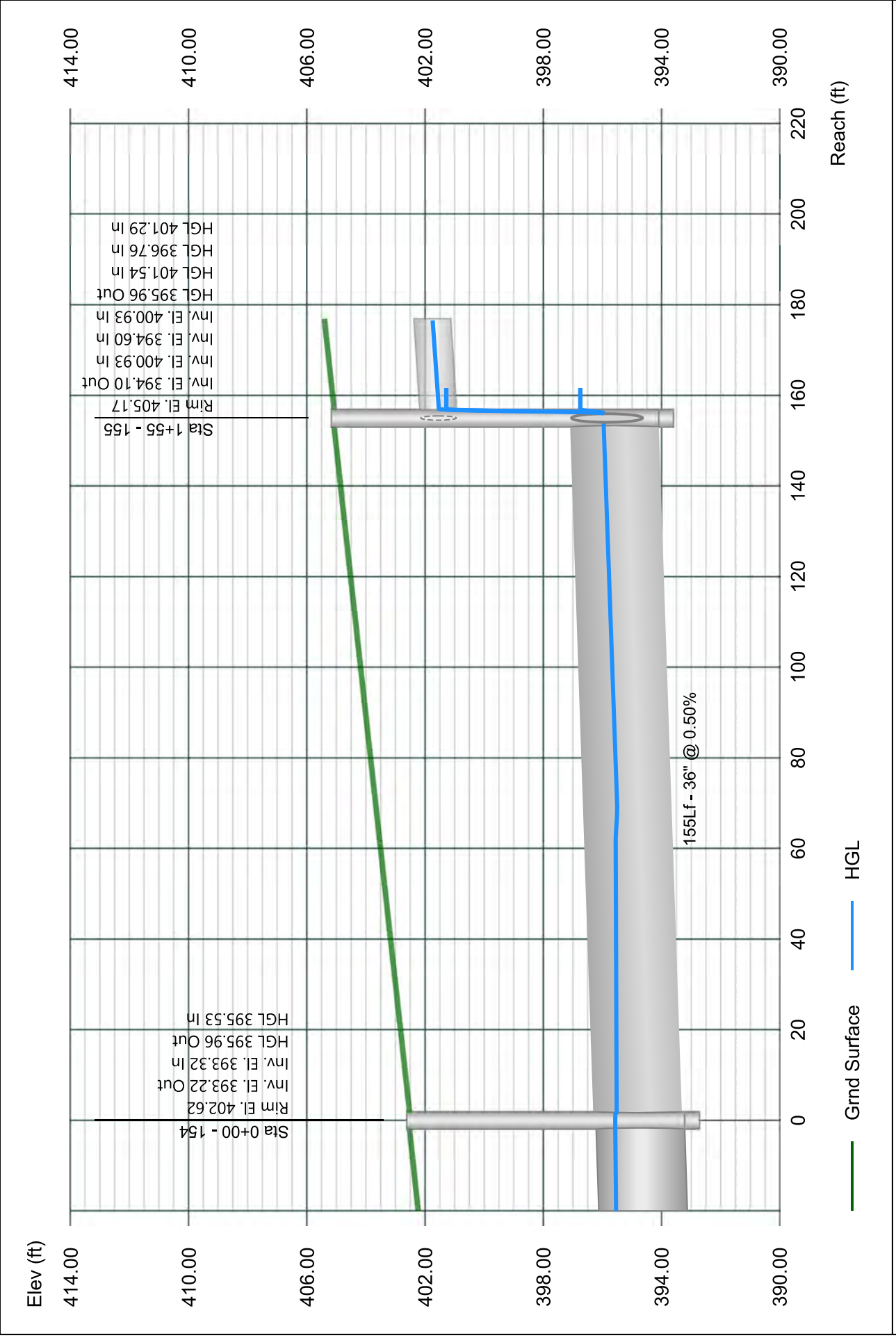

Line 56 - 156 TO 155

Stormwater Studio 2024 v 3.0.0.33

Project Name: Enter Project Name...

01-19-2024

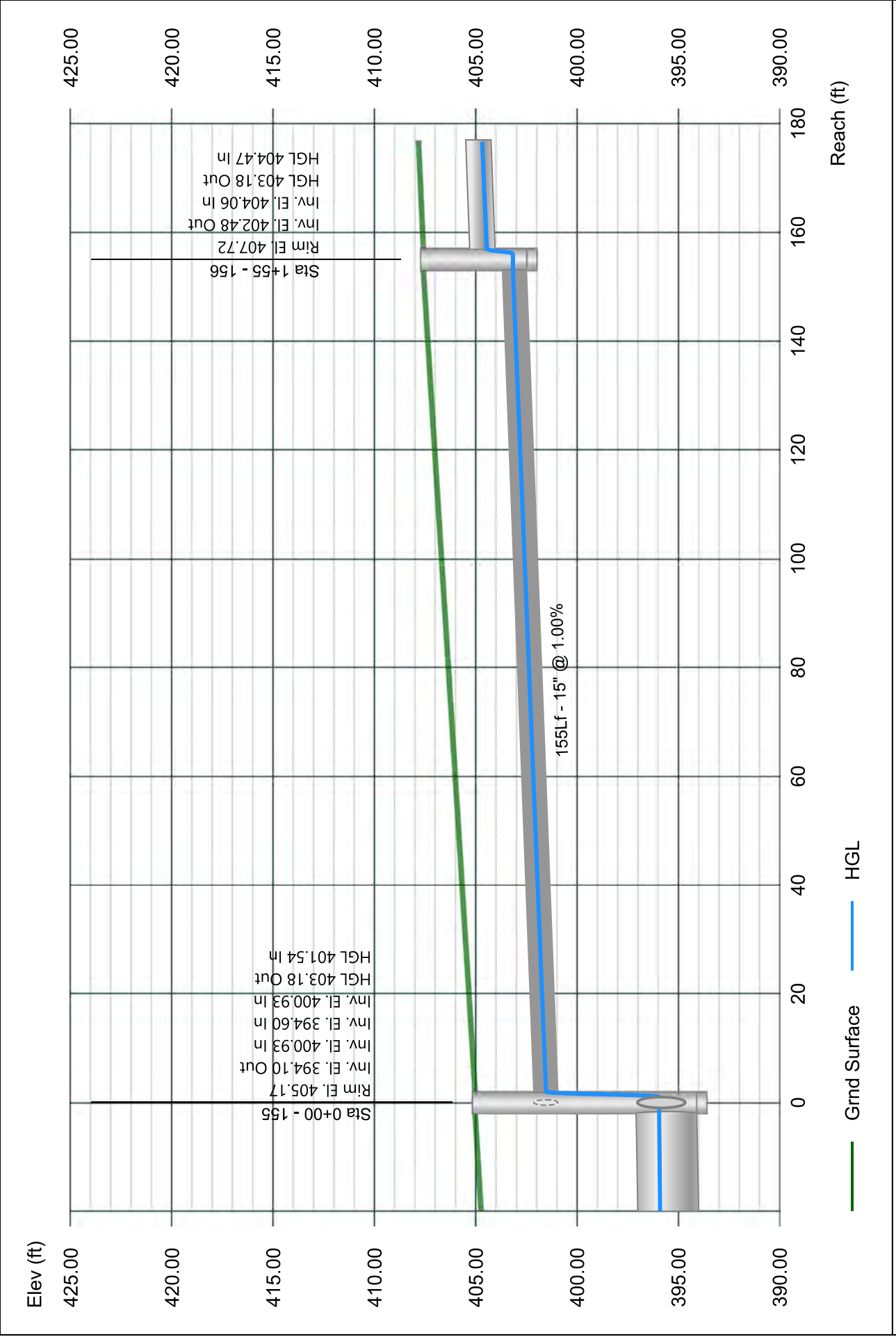

Line 57 - 157 TO 156

Stormwater Studio 2024 v 3.0.0.33

Project Name: Enter Project Name...

01-19-2024

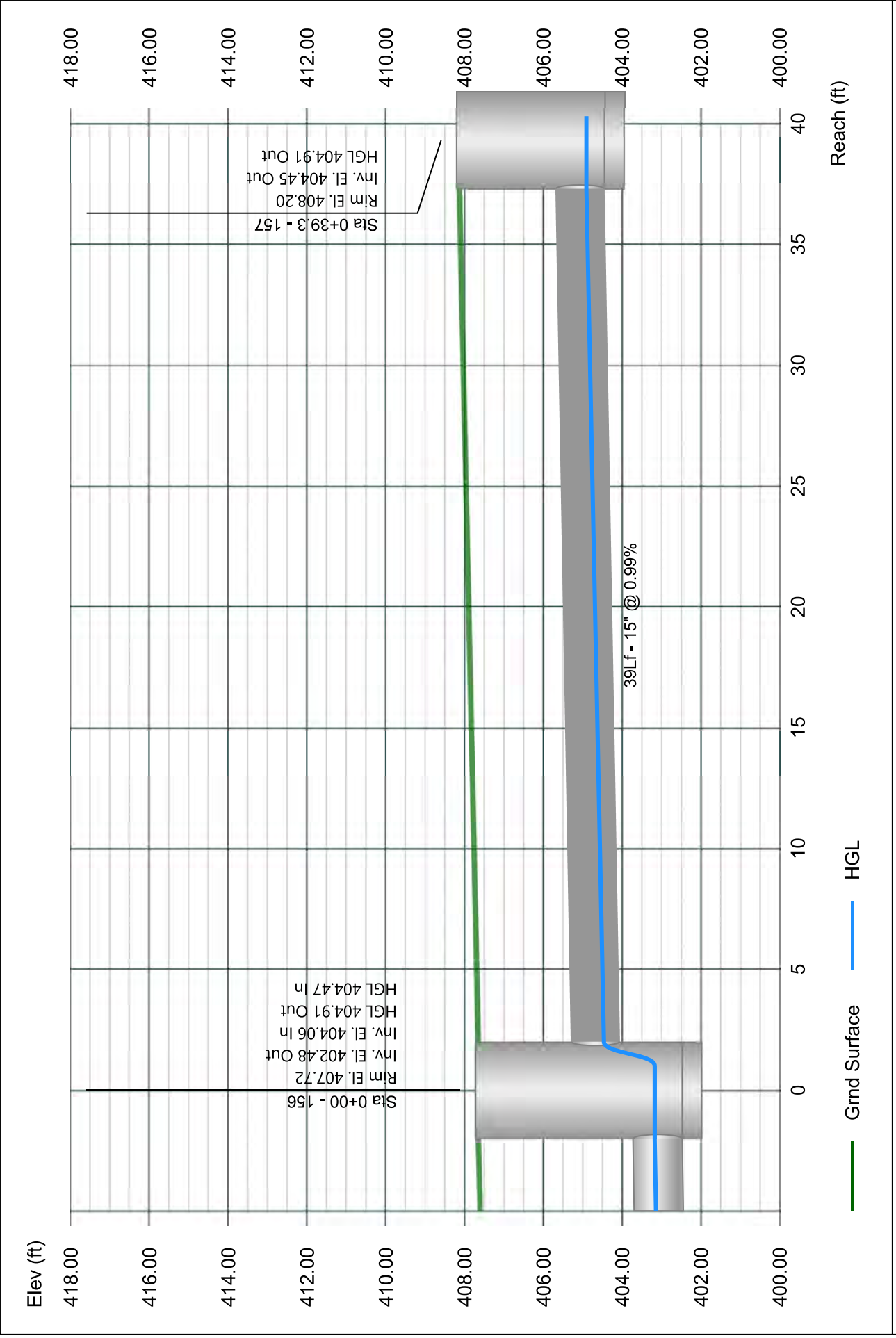

Line 58 - 158 TO 155

Stormwater Studio 2024 v 3.0.0.33

Project Name: Enter Project Name...

01-19-2024

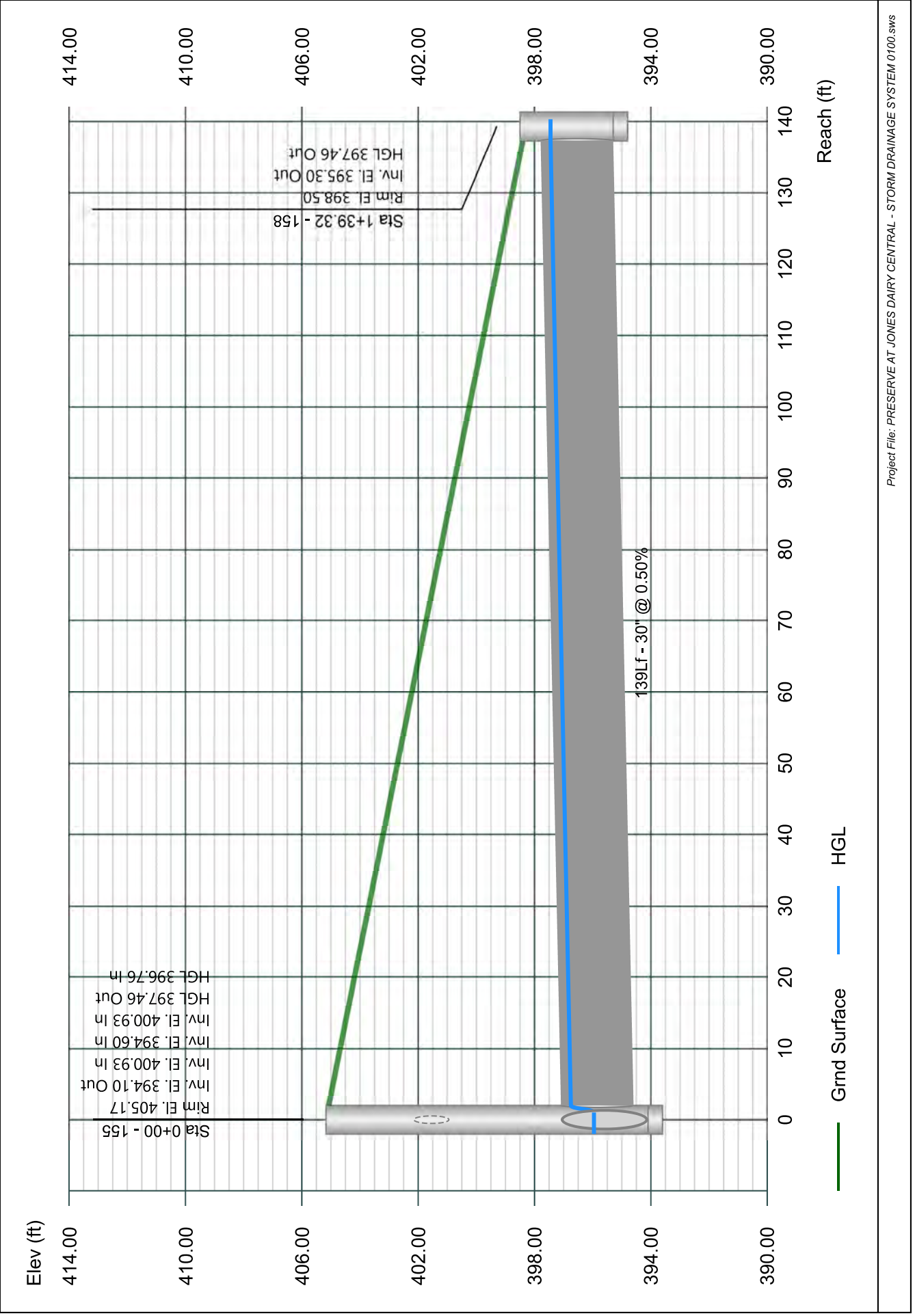

Line 59 - 159 TO 155

Stormwater Studio 2024 v 3.0.0.33

Project Name: Enter Project Name...

01-19-2024

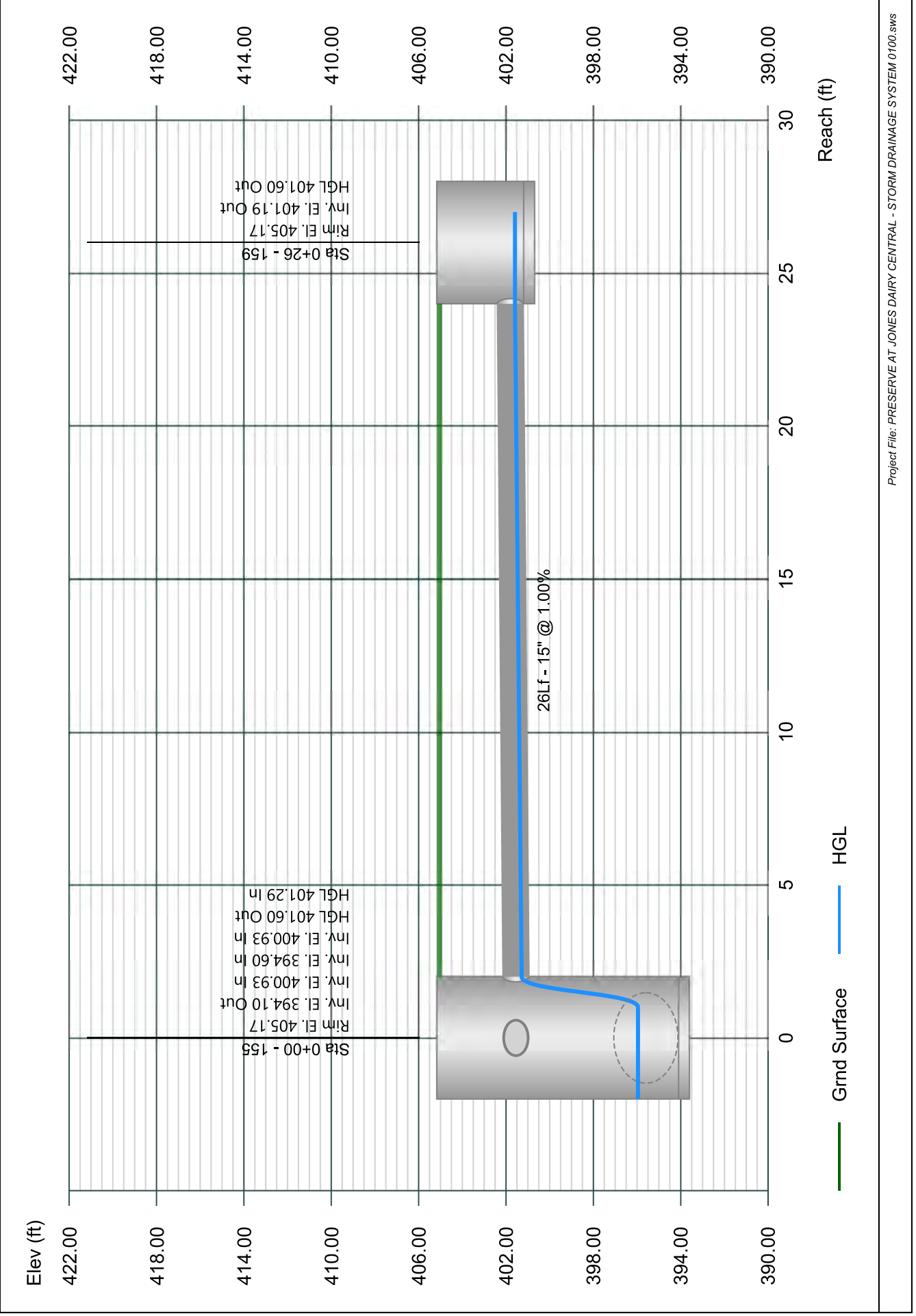

Line 60 - 160 TO 153

Stormwater Studio 2024 v 3.0.0.33

Project Name: Enter Project Name...

01-19-2024

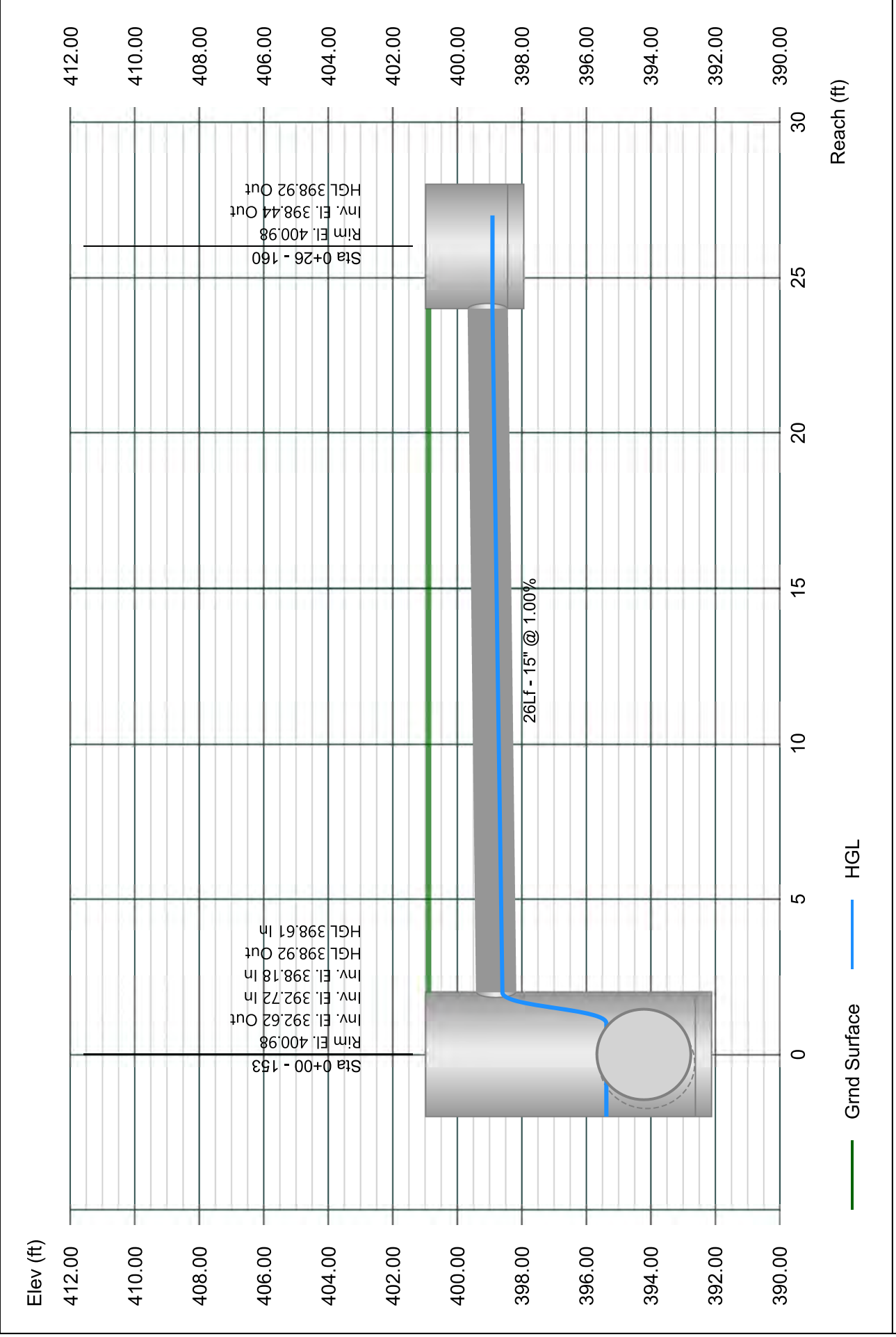

Line 61 - 161 TO 152

Stormwater Studio 2024 v 3.0.0.33

Project Name: Enter Project Name...

01-19-2024

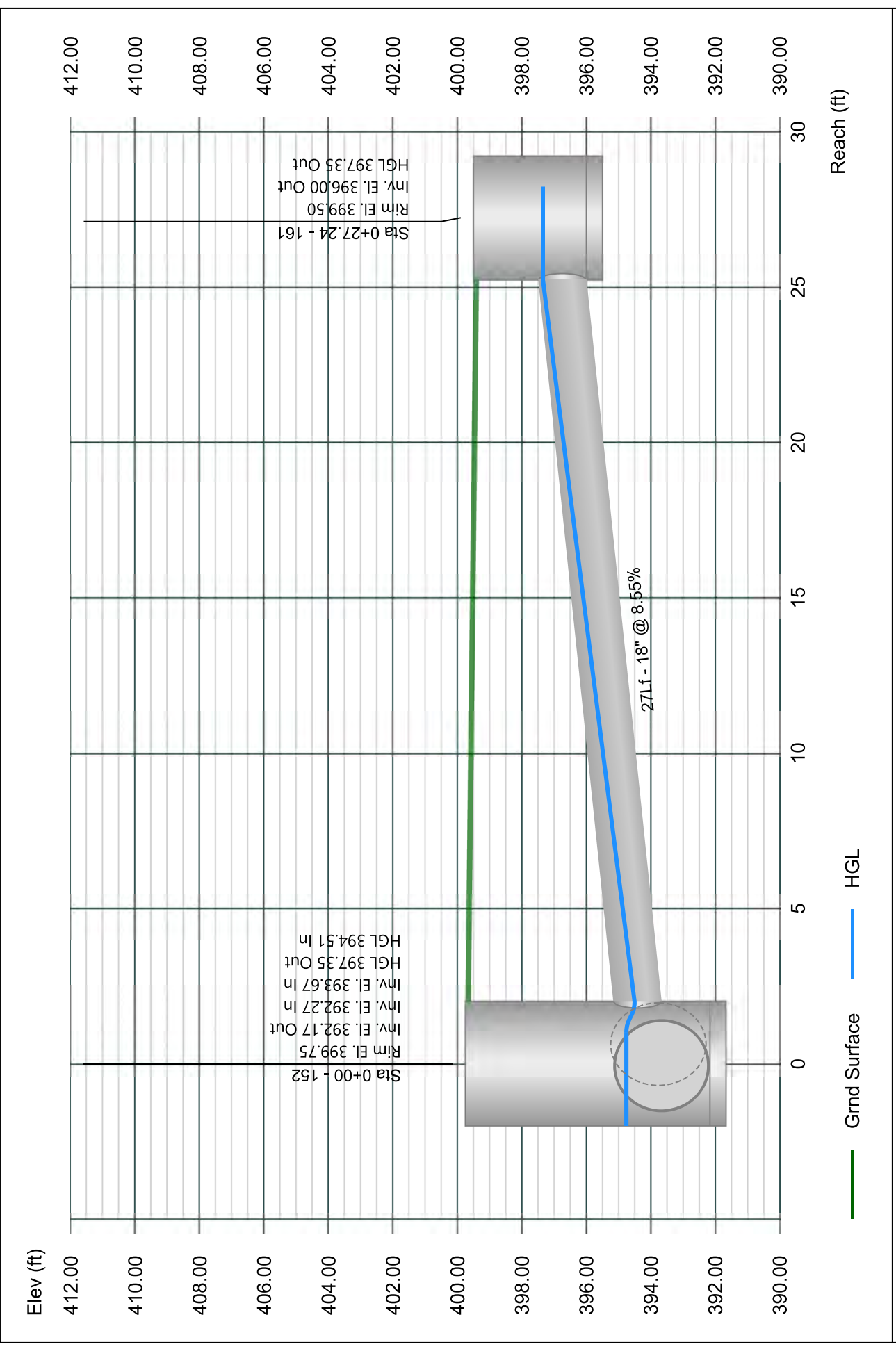

Line 62 - 163 TO 151

Stormwater Studio 2024 v 3.0.0.33

Project Name: Enter Project Name...

01-19-2024

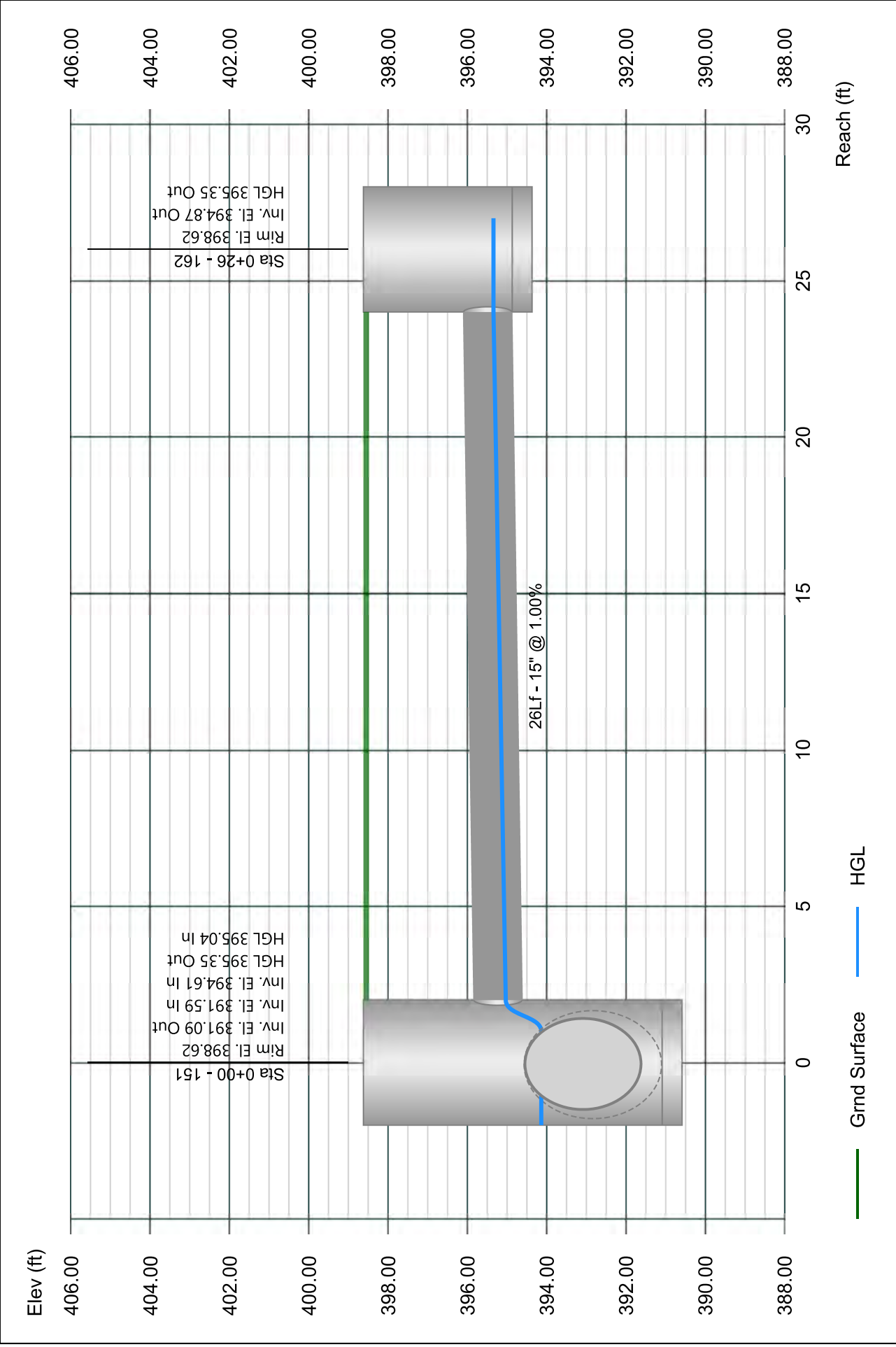

Line 63 - 163 TO 101

Stormwater Studio 2024 v 3.0.0.33

Project Name: Enter Project Name...

01-19-2024

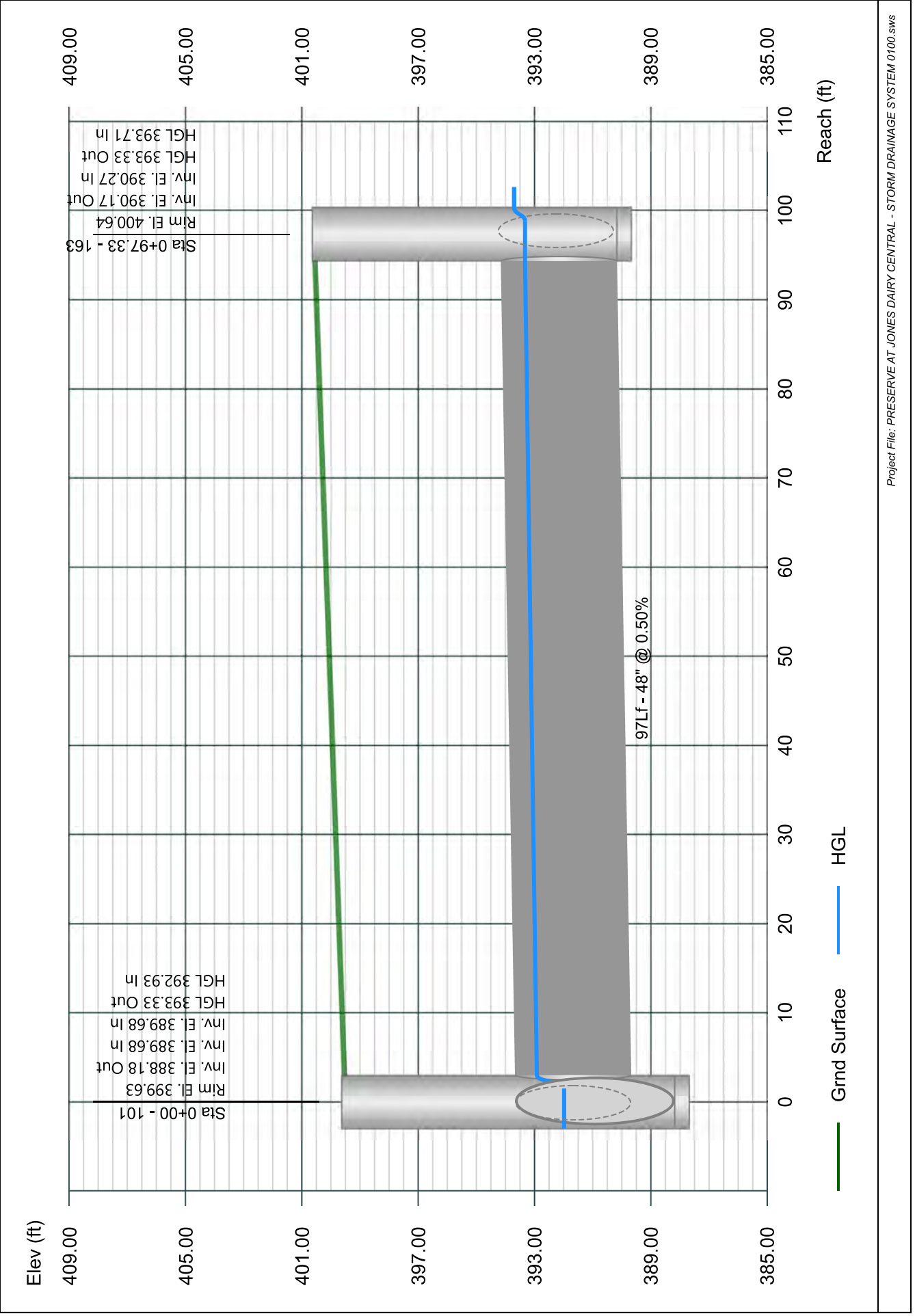

Line 64 - 164 TO 163

Stormwater Studio 2024 v 3.0.0.33

Project Name: Enter Project Name...

01-19-2024

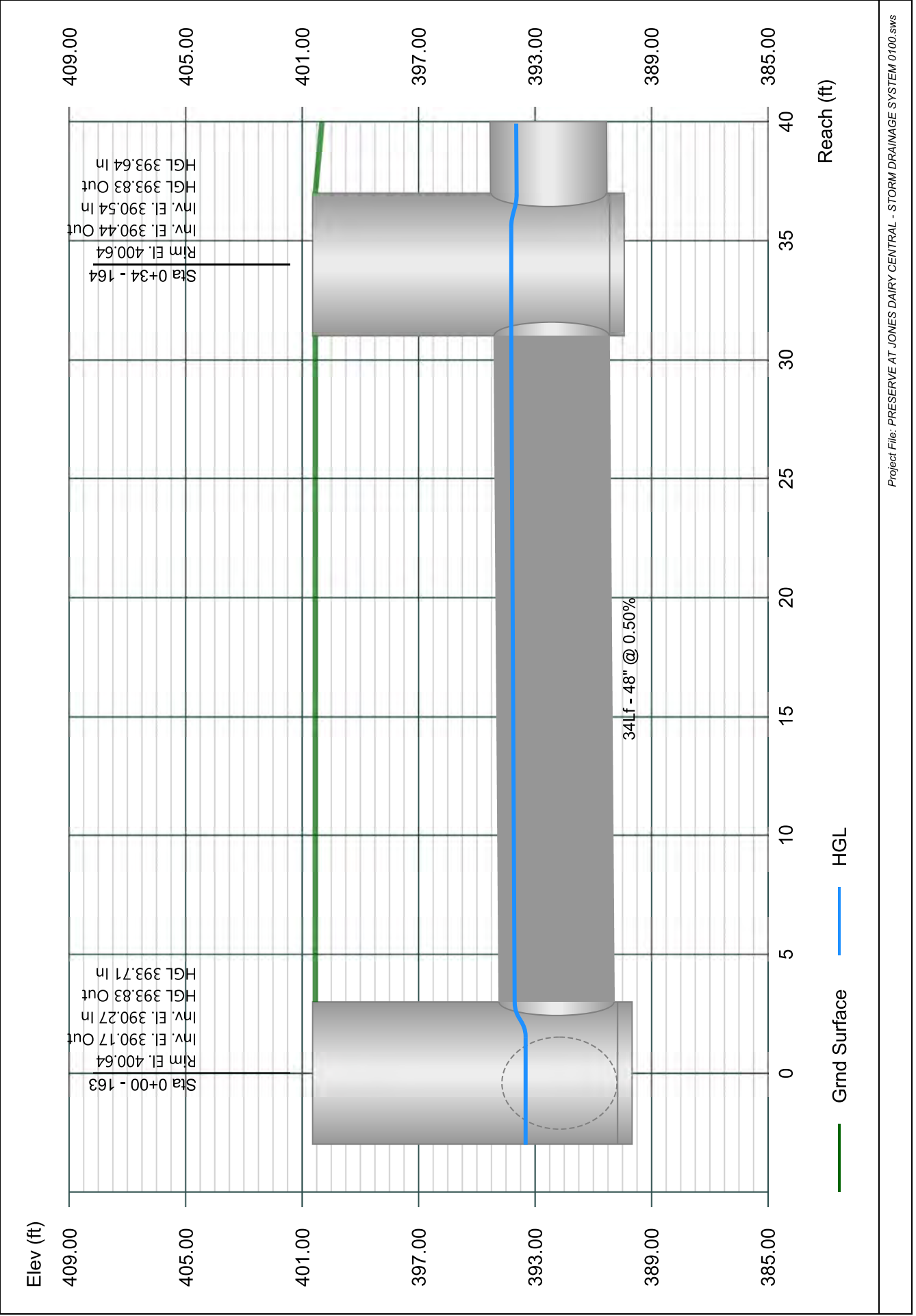

Line 65 - 165 TO 164

Stormwater Studio 2024 v 3.0.0.33

Project Name: Enter Project Name...

01-19-2024

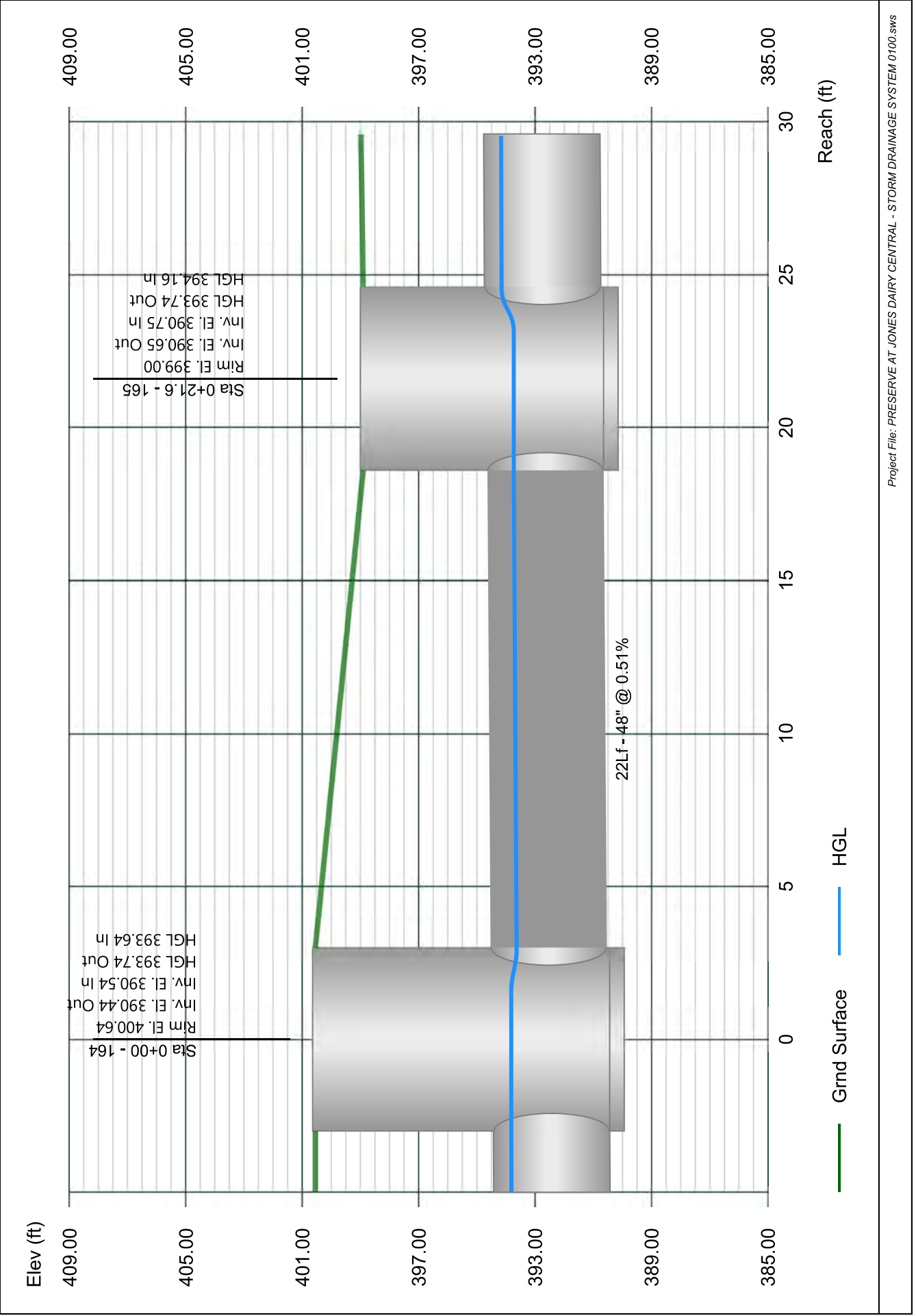

Line 66 - 166 TO 165

Stormwater Studio 2024 v 3.0.0.33

Project Name: Enter Project Name...

01-19-2024

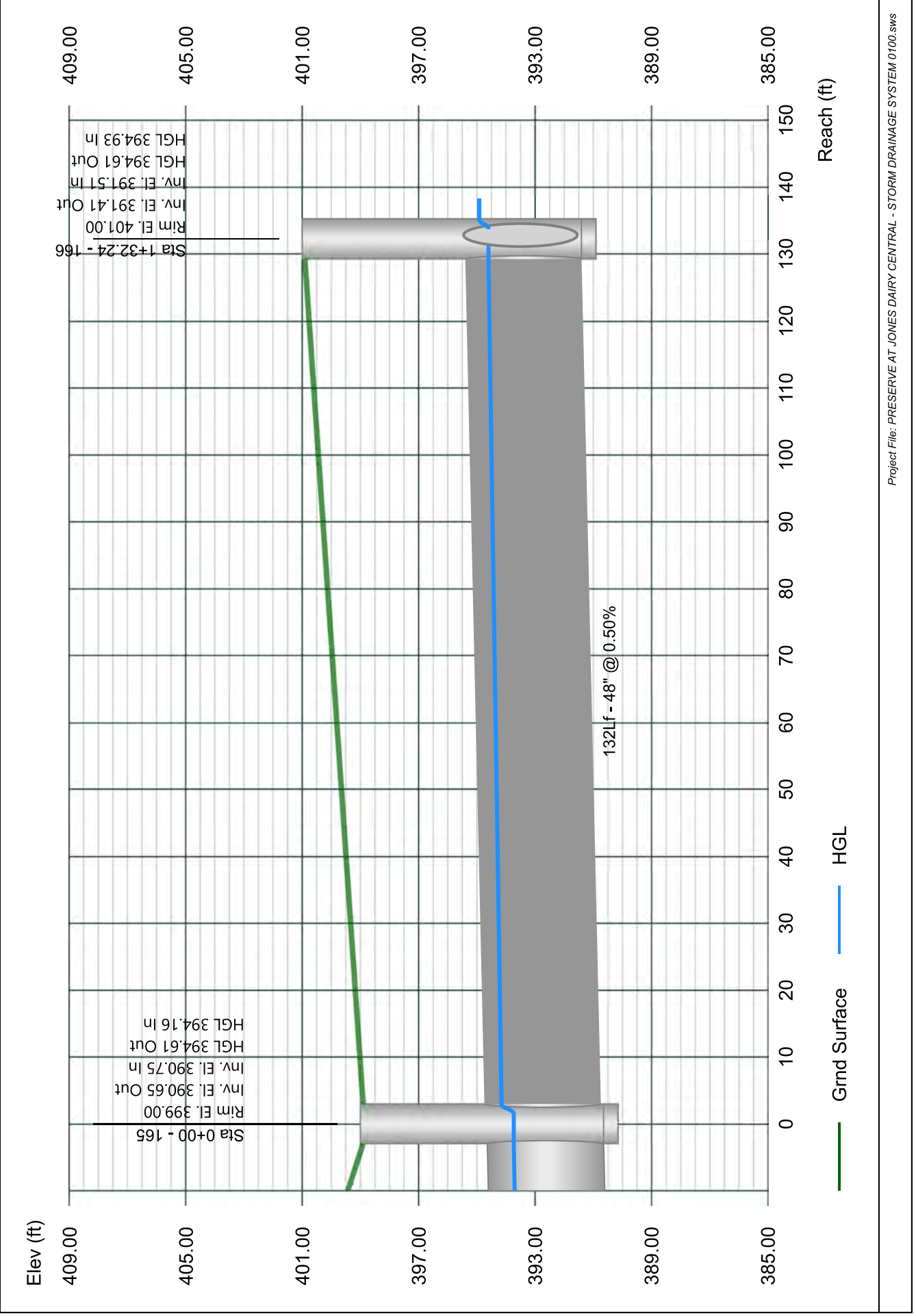

Line 67 - 167 TO 166

Stormwater Studio 2024 v 3.0.0.33

Project Name: Enter Project Name...

01-19-2024

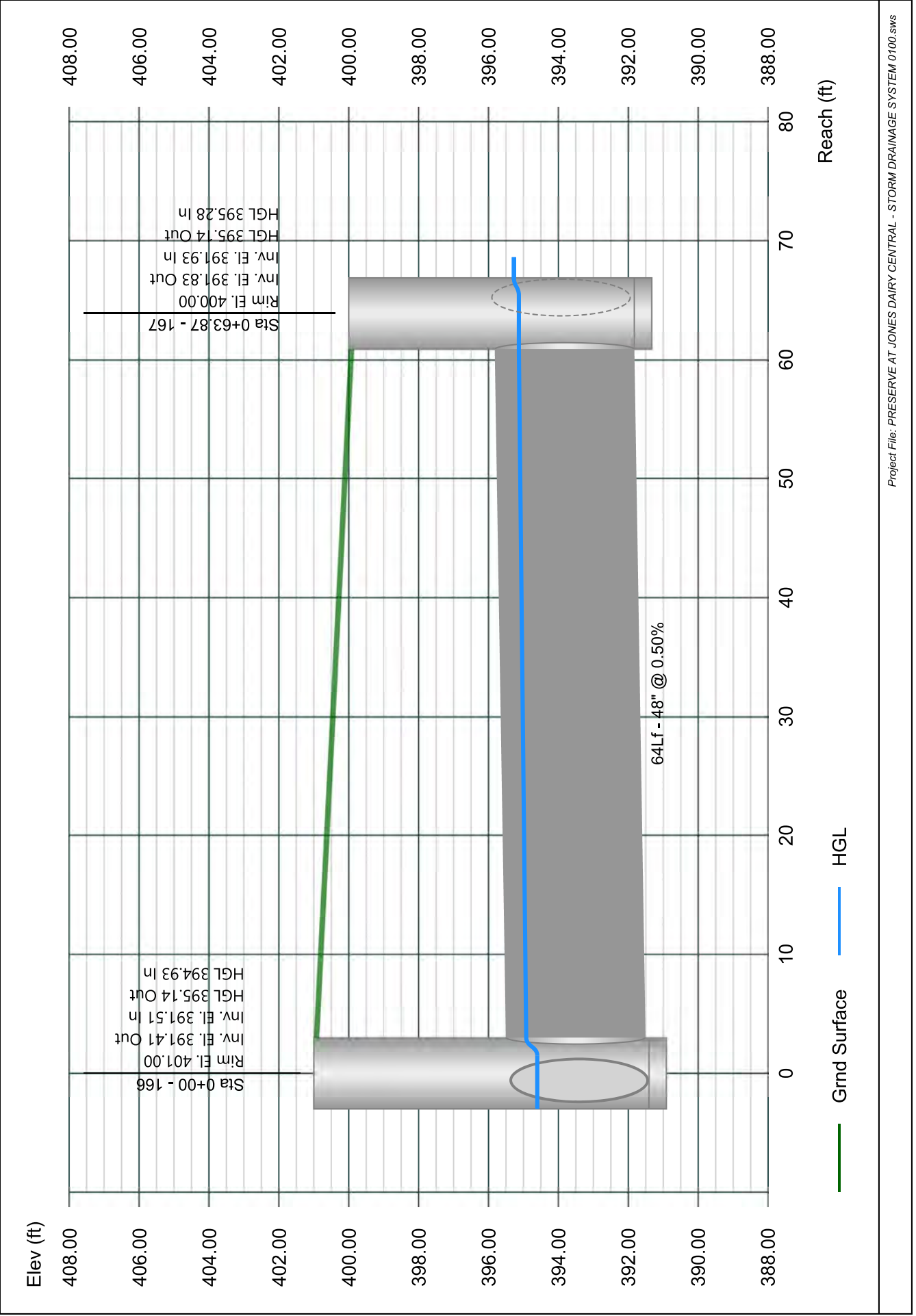

Line 68 - 168 TO 167

Stormwater Studio 2024 v 3.0.0.33

Project Name: Enter Project Name...

01-19-2024

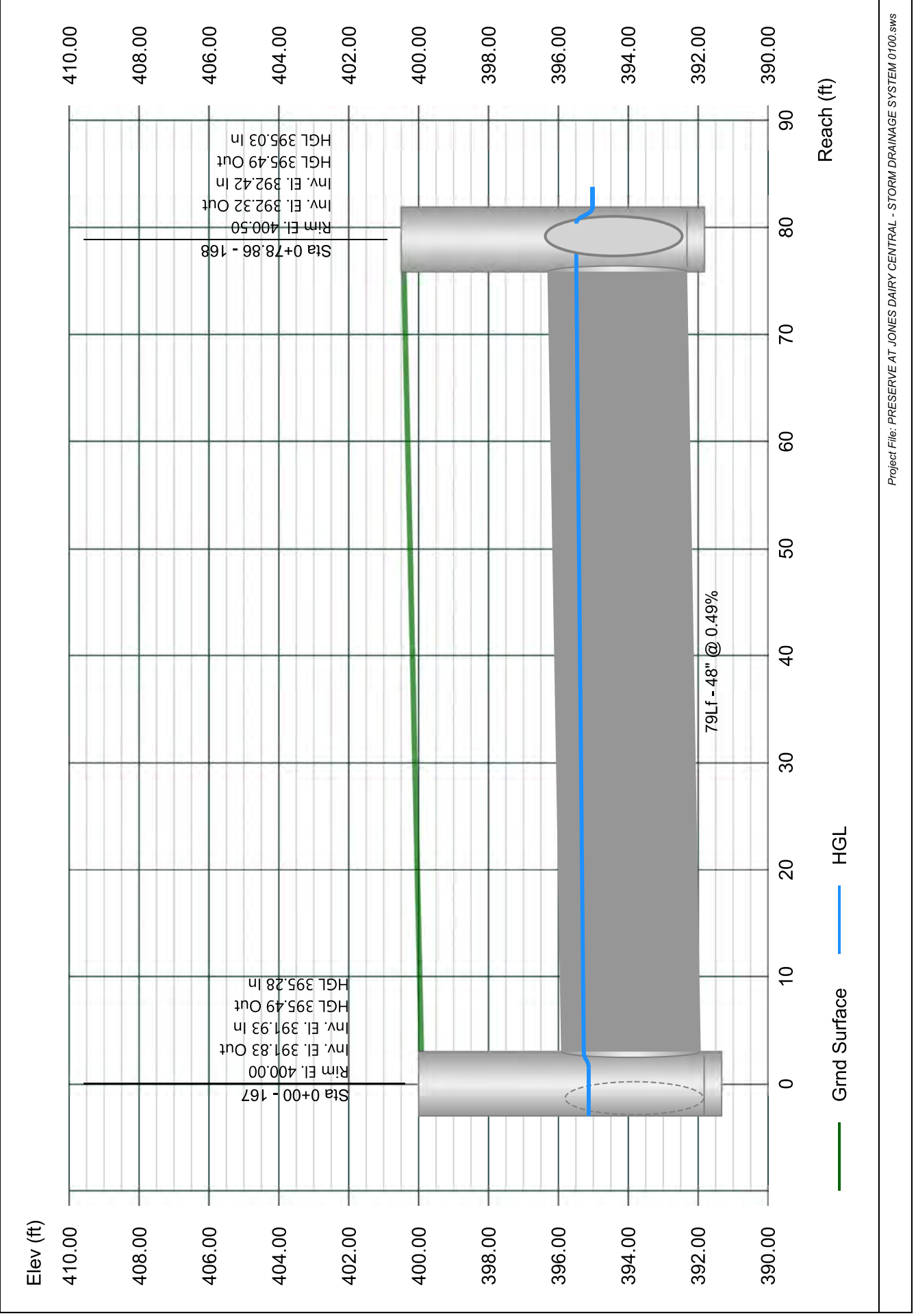

Line 69 - 169 TO 168

Stormwater Studio 2024 v 3.0.0.33

Project Name: Enter Project Name...

01-19-2024

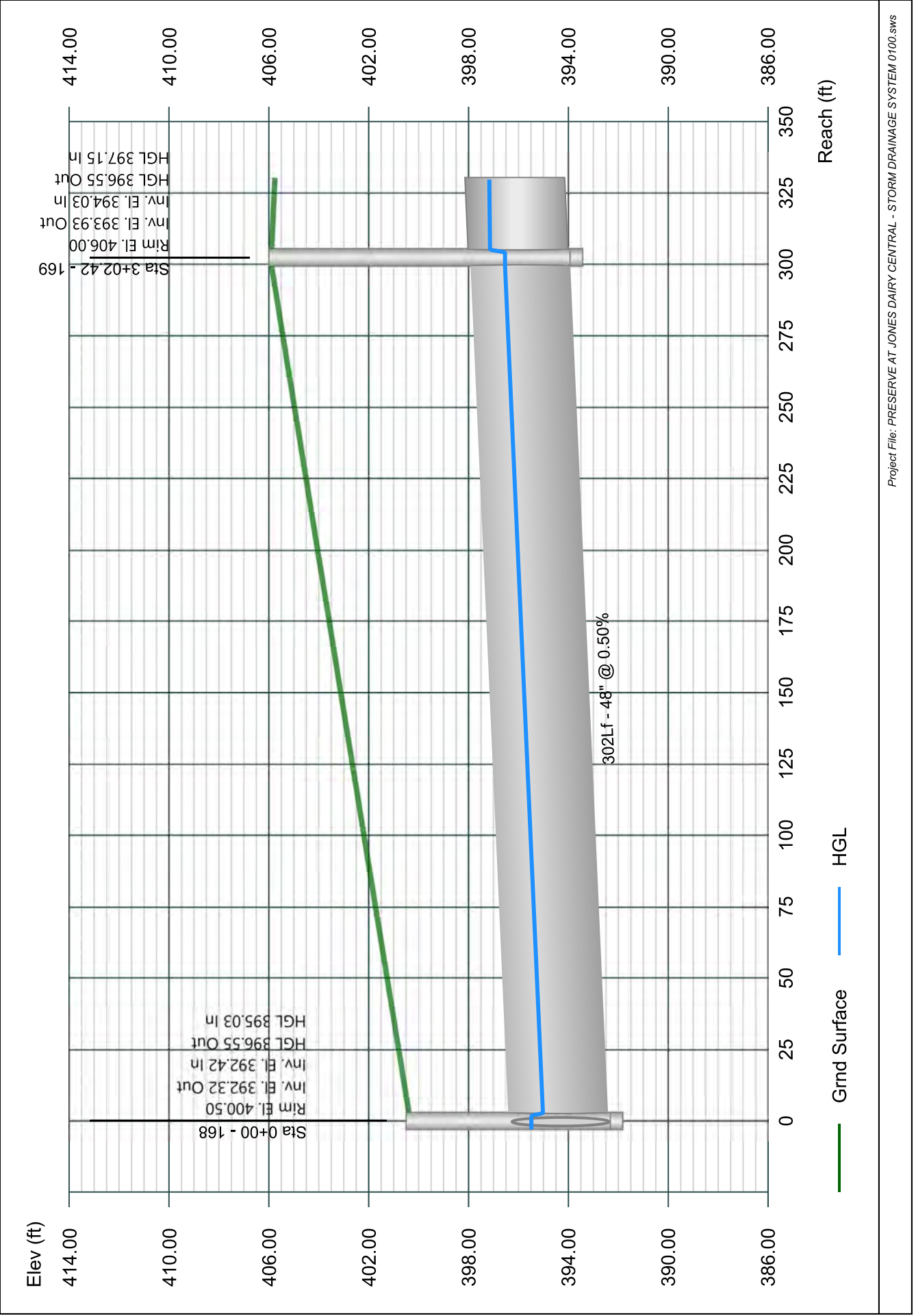

Line 70 - 170 TO 169

Stormwater Studio 2024 v 3.0.0.33

Project Name: Enter Project Name...

01-19-2024

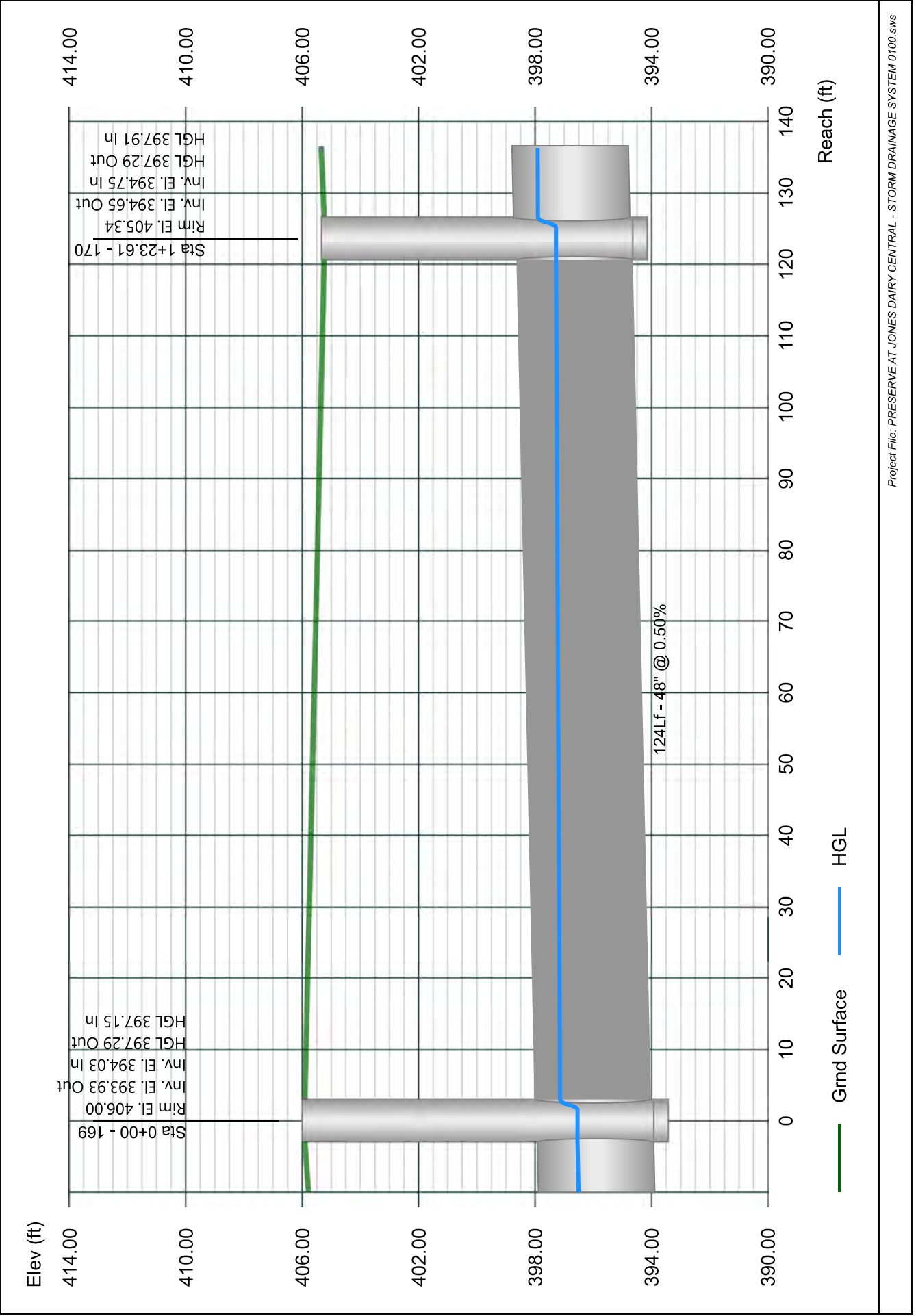

Line 71 - 171 TO 170

Stormwater Studio 2024 v 3.0.0.33

Project Name: Enter Project Name...

01-19-2024

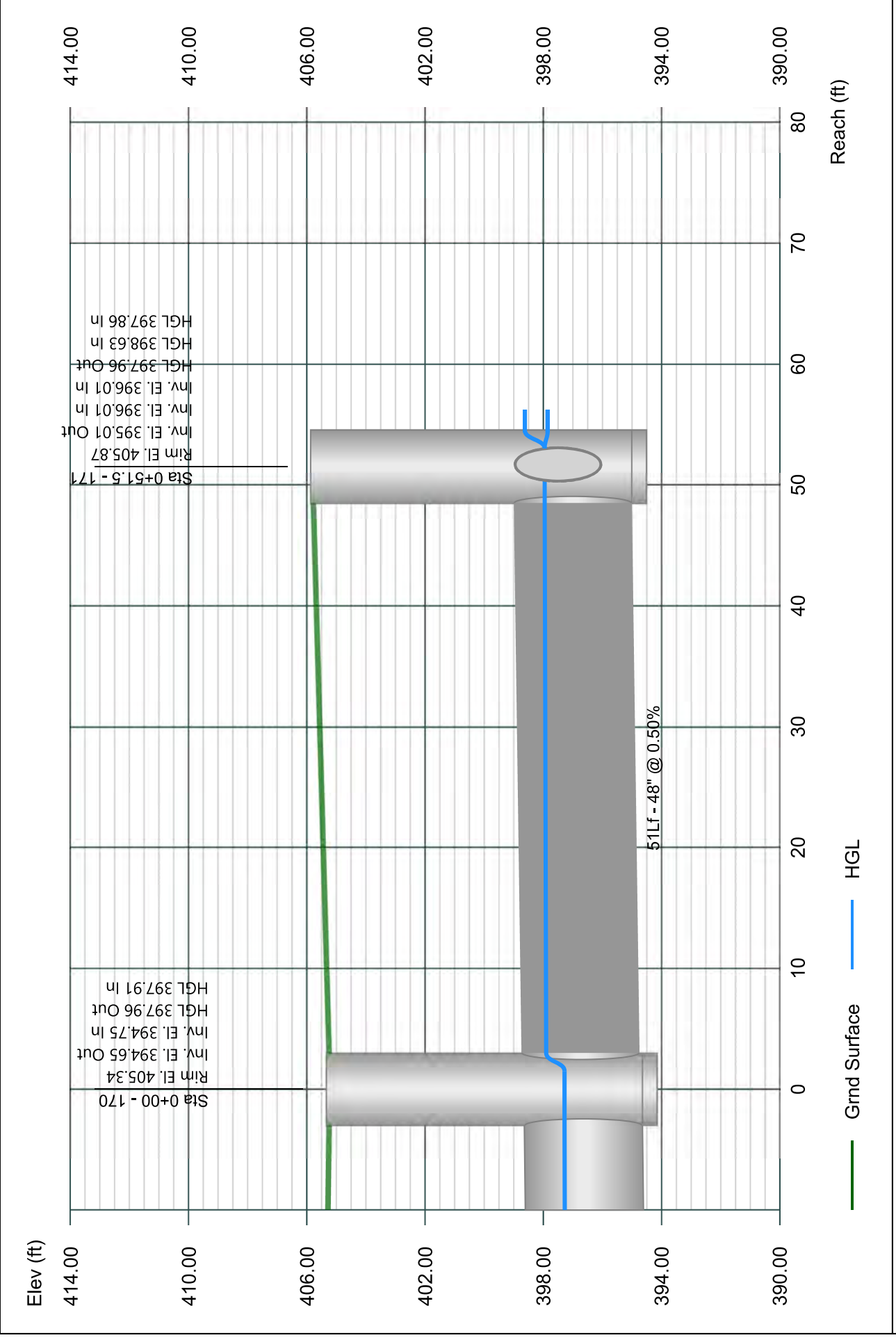

Line 72 - 172 TO 171

Stormwater Studio 2024 v 3.0.0.33

Project Name: Enter Project Name...

01-19-2024

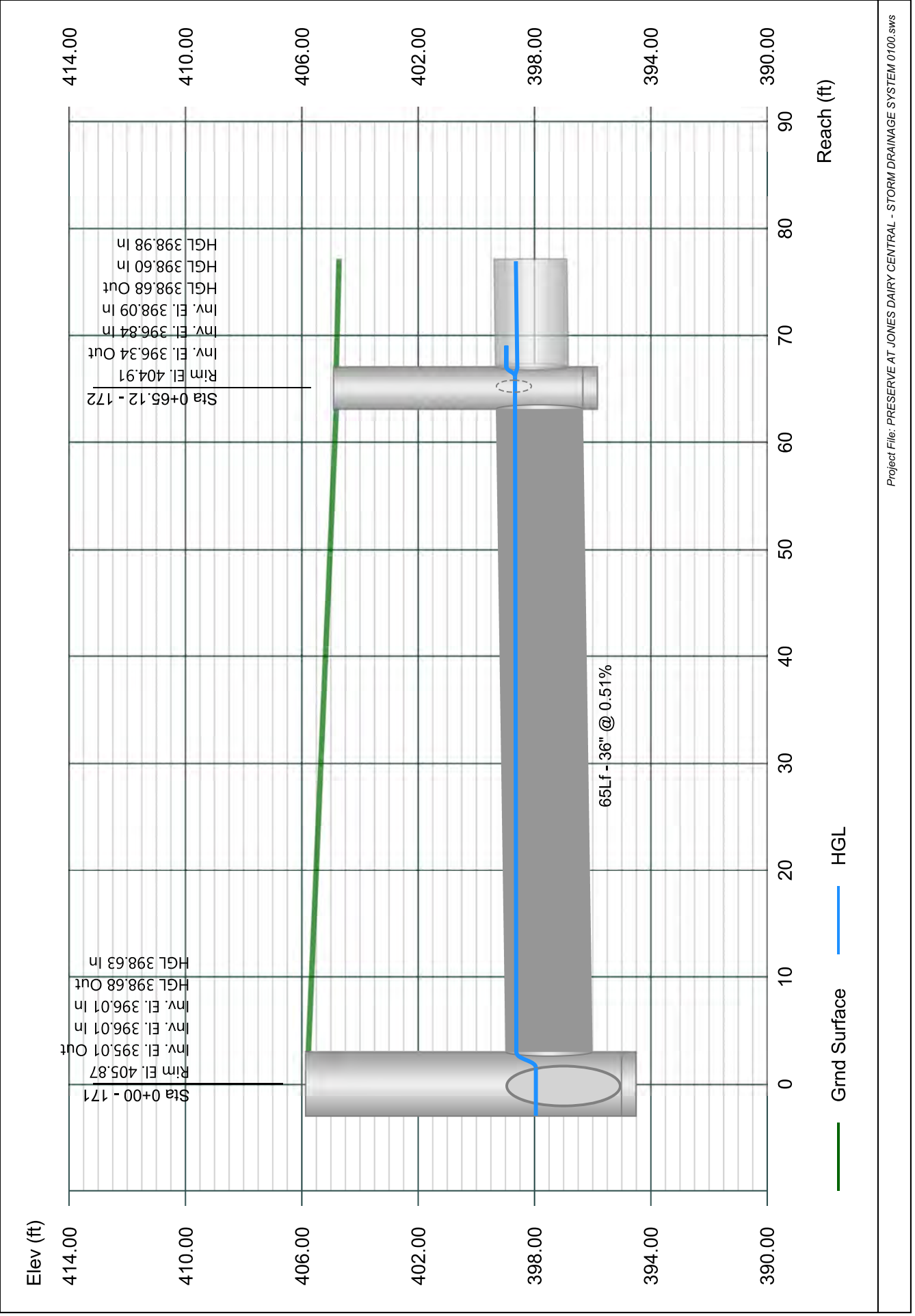

Line 73 - 173 TO 172

Stormwater Studio 2024 v 3.0.0.33

Project Name: Enter Project Name...

01-19-2024

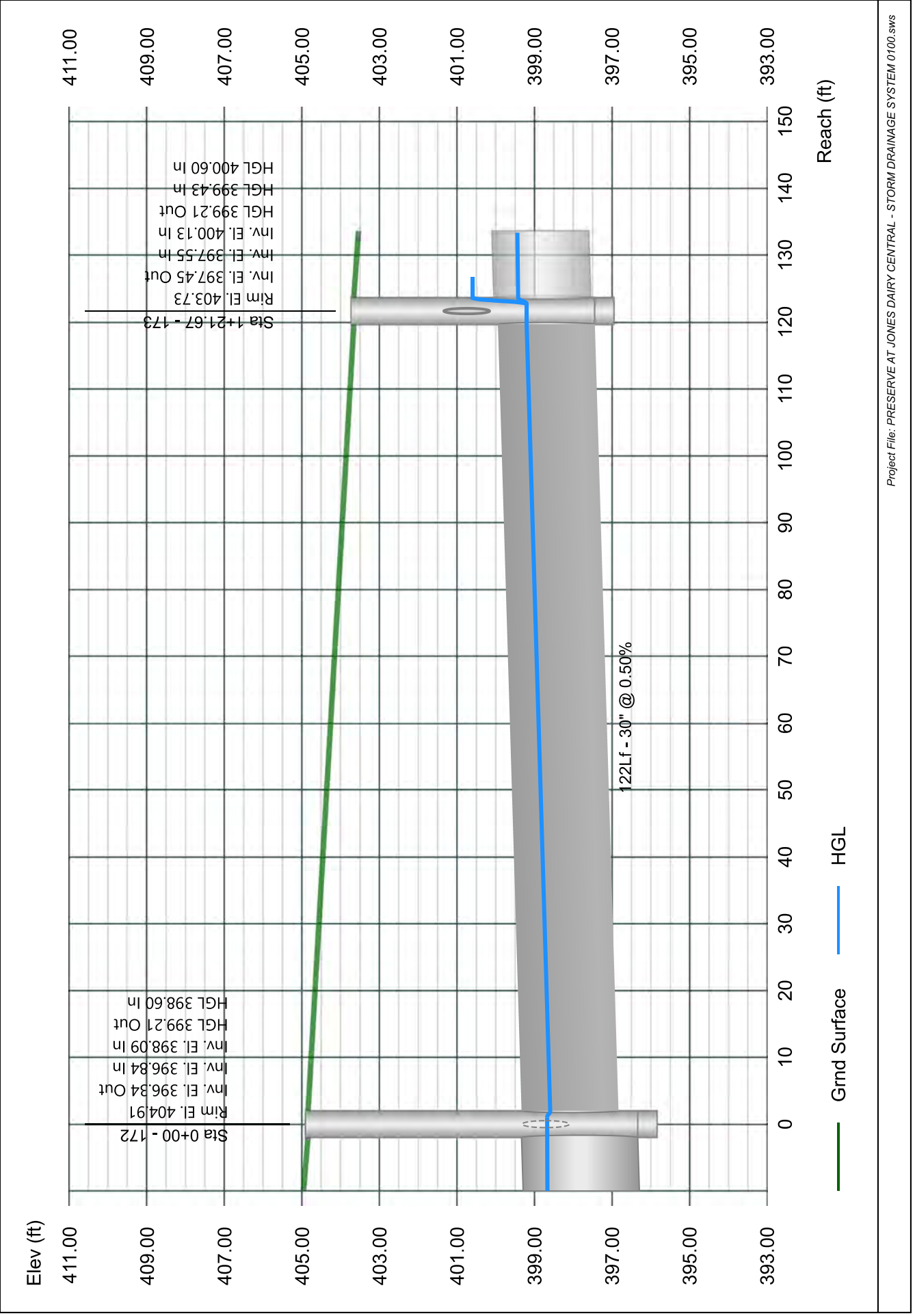

Line 74 - 174 TO 173

Stormwater Studio 2024 v 3.0.0.33

Project Name: Enter Project Name...

01-19-2024

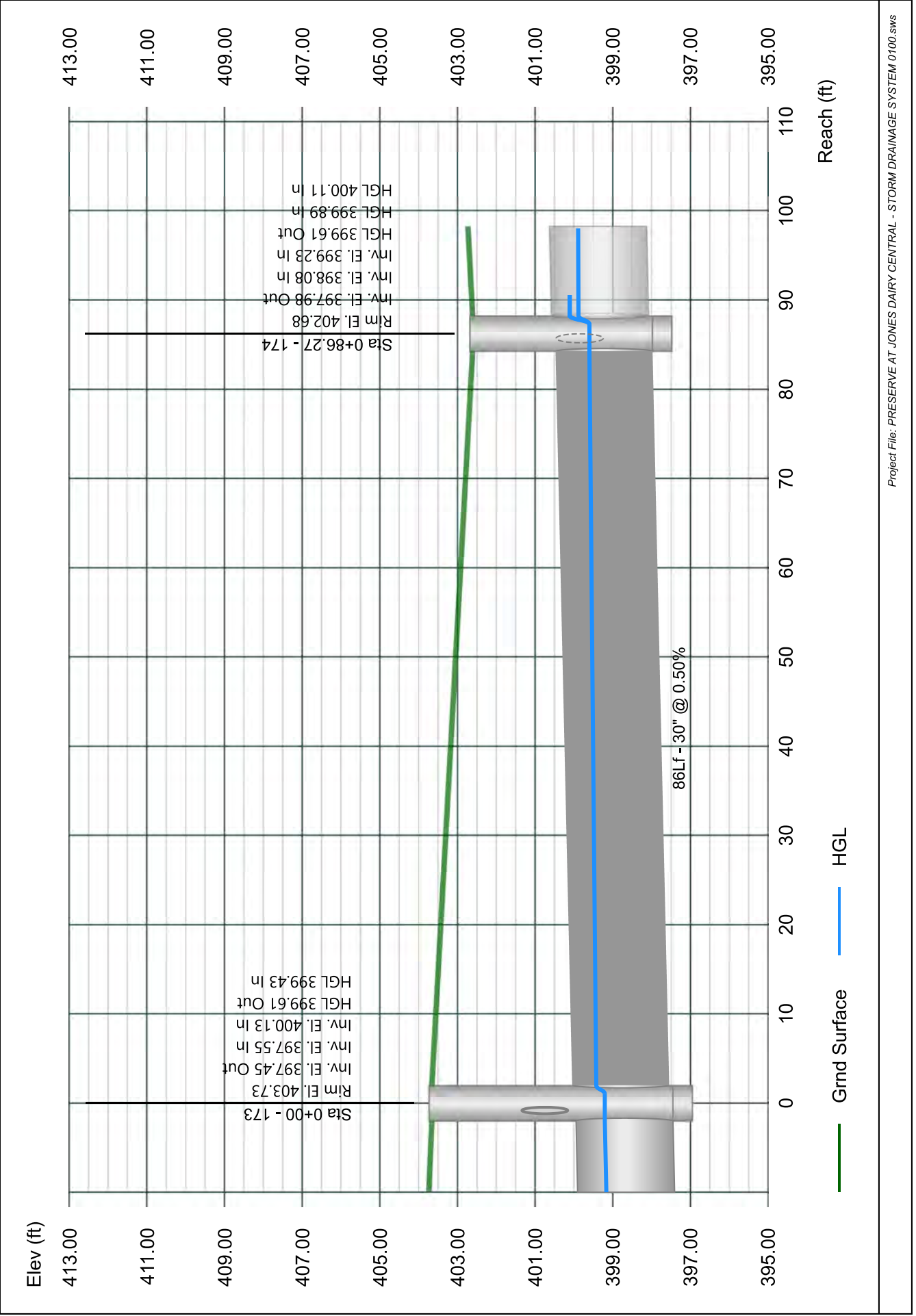

Line 75 - 175 TO 174

Stormwater Studio 2024 v 3.0.0.33

Project Name: Enter Project Name...

01-19-2024

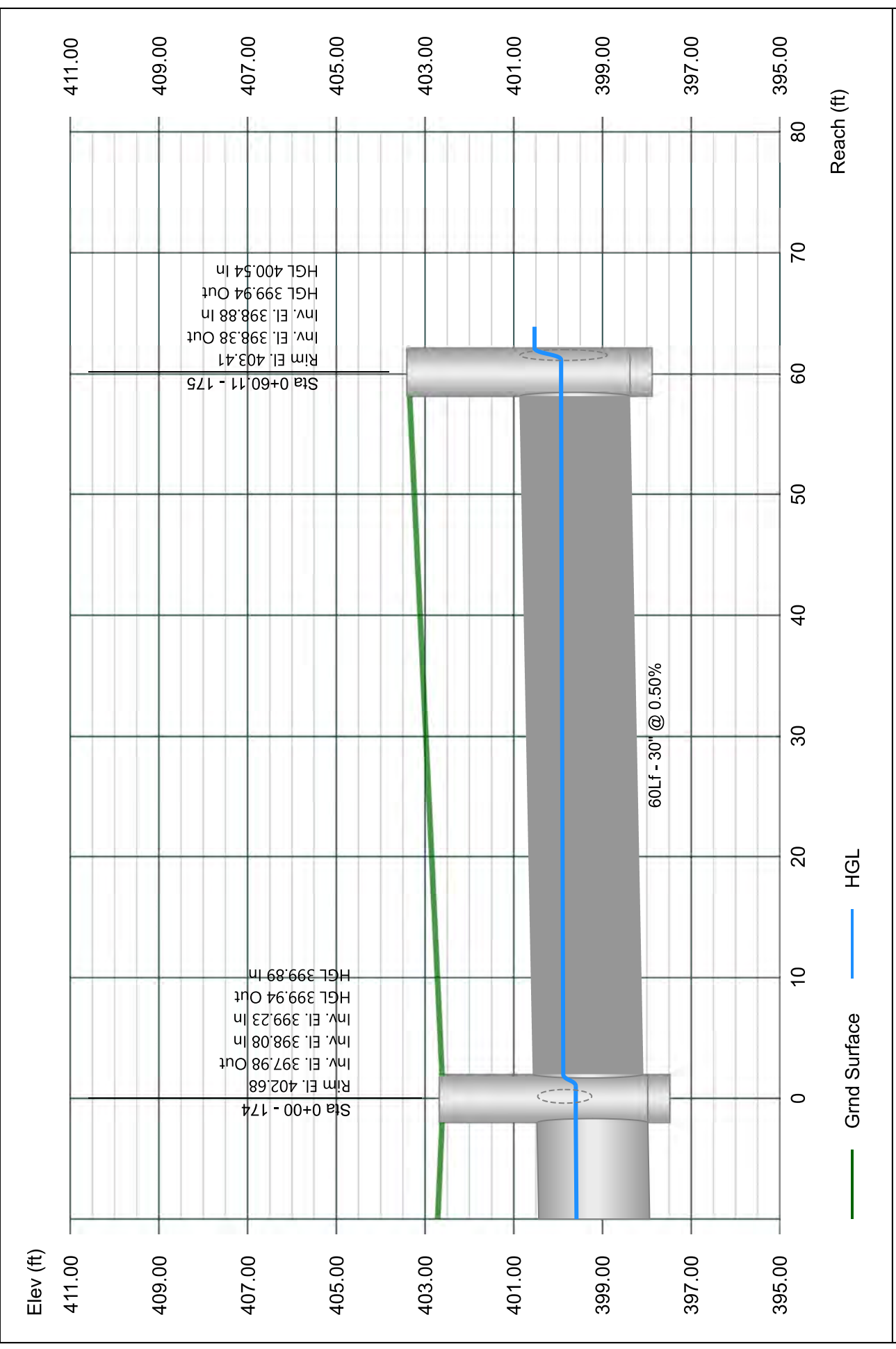

Line 76 - 176 TO 175

Stormwater Studio 2024 v 3.0.0.33

Project Name: Enter Project Name...

01-19-2024

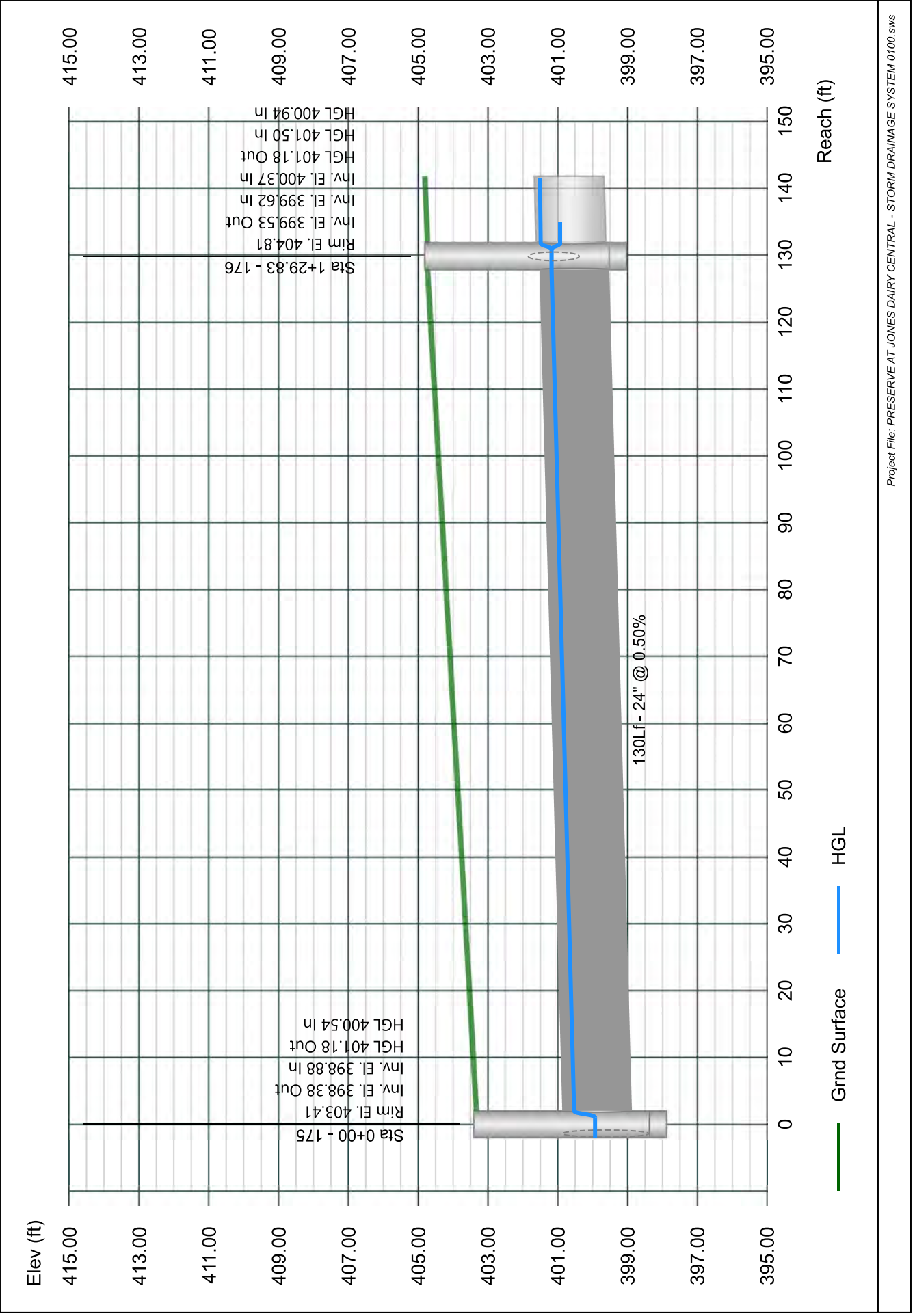

Line 77 - 177 TO 176

Stormwater Studio 2024 v 3.0.0.33

Project Name: Enter Project Name...

01-19-2024

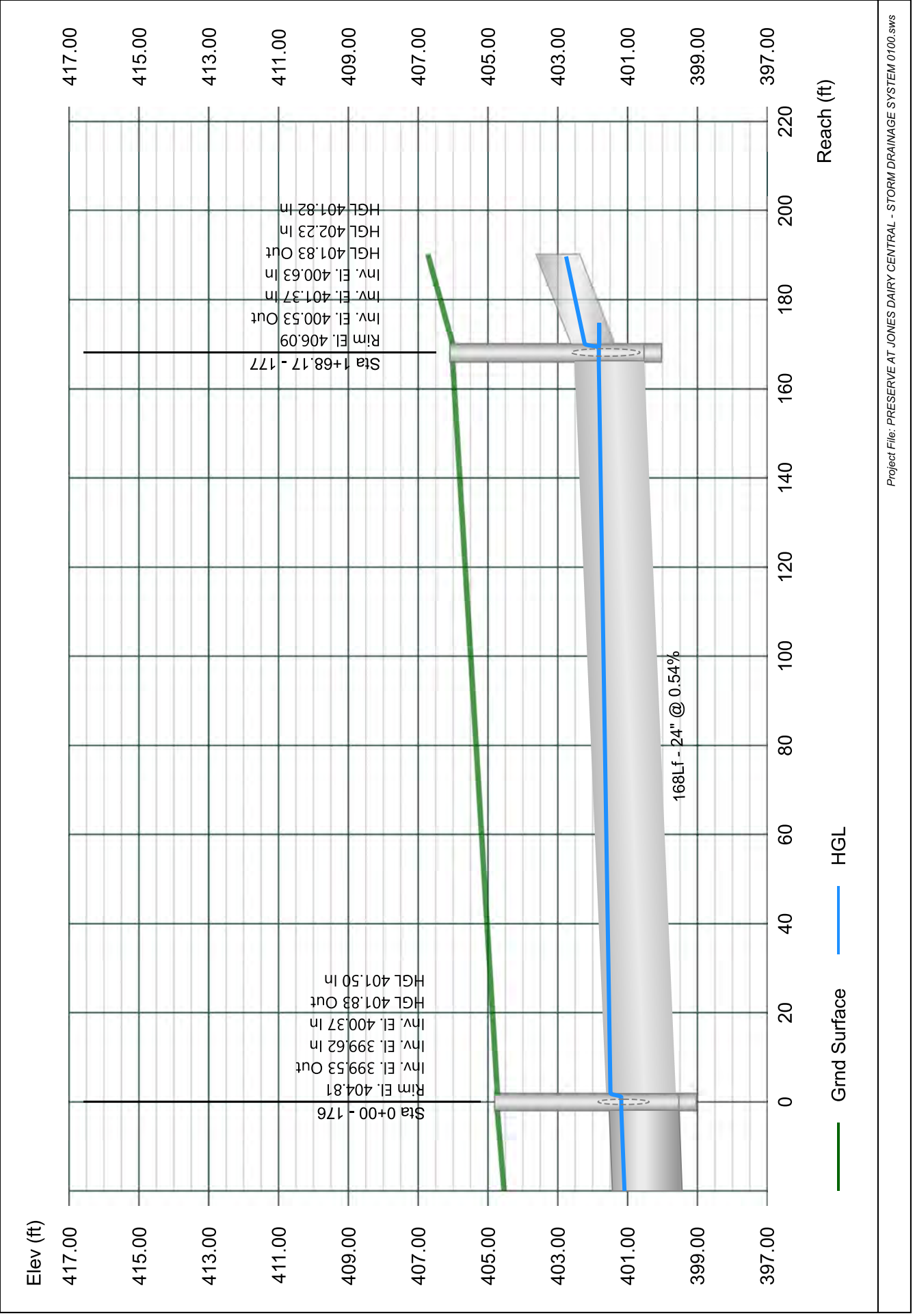

Line 78 - 178 TO 177

Stormwater Studio 2024 v 3.0.0.33

Project Name: Enter Project Name...

01-19-2024

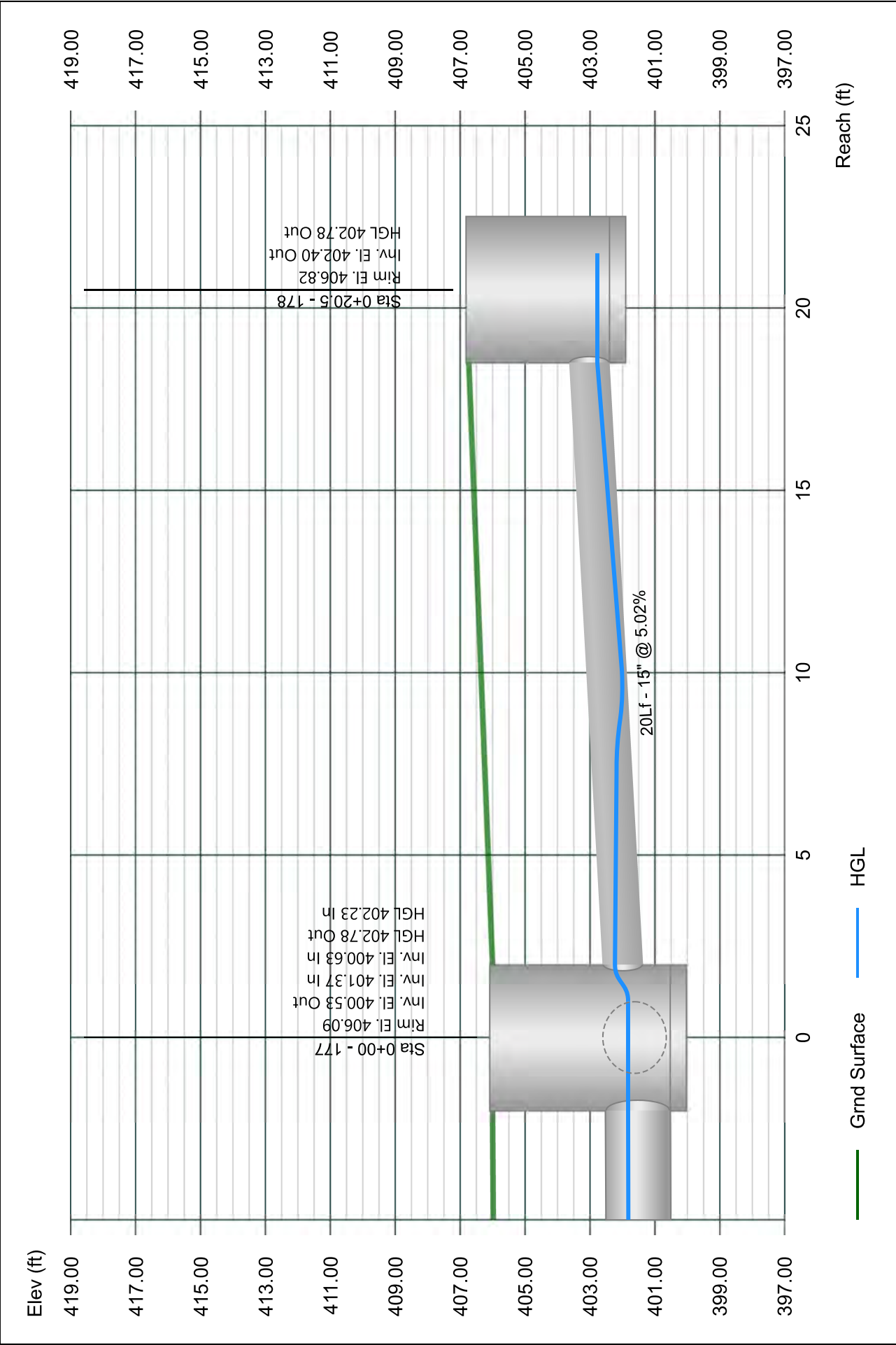

Line 79 - 179 TO 177

Stormwater Studio 2024 v 3.0.0.33

Project Name: Enter Project Name...

01-19-2024

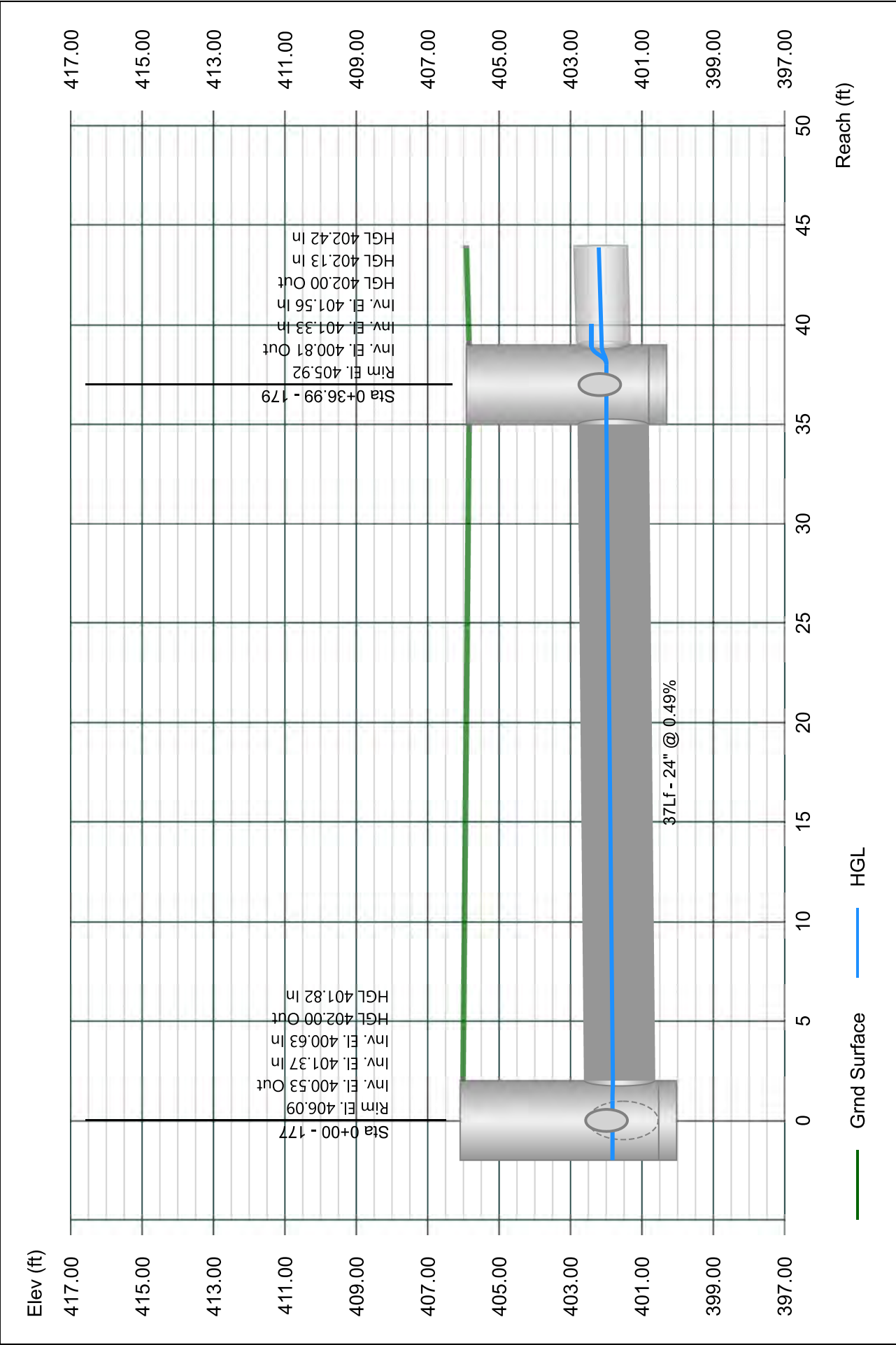

Line 80 - 180 TO 179

Stormwater Studio 2024 v 3.0.0.33

Project Name: Enter Project Name...

01-19-2024

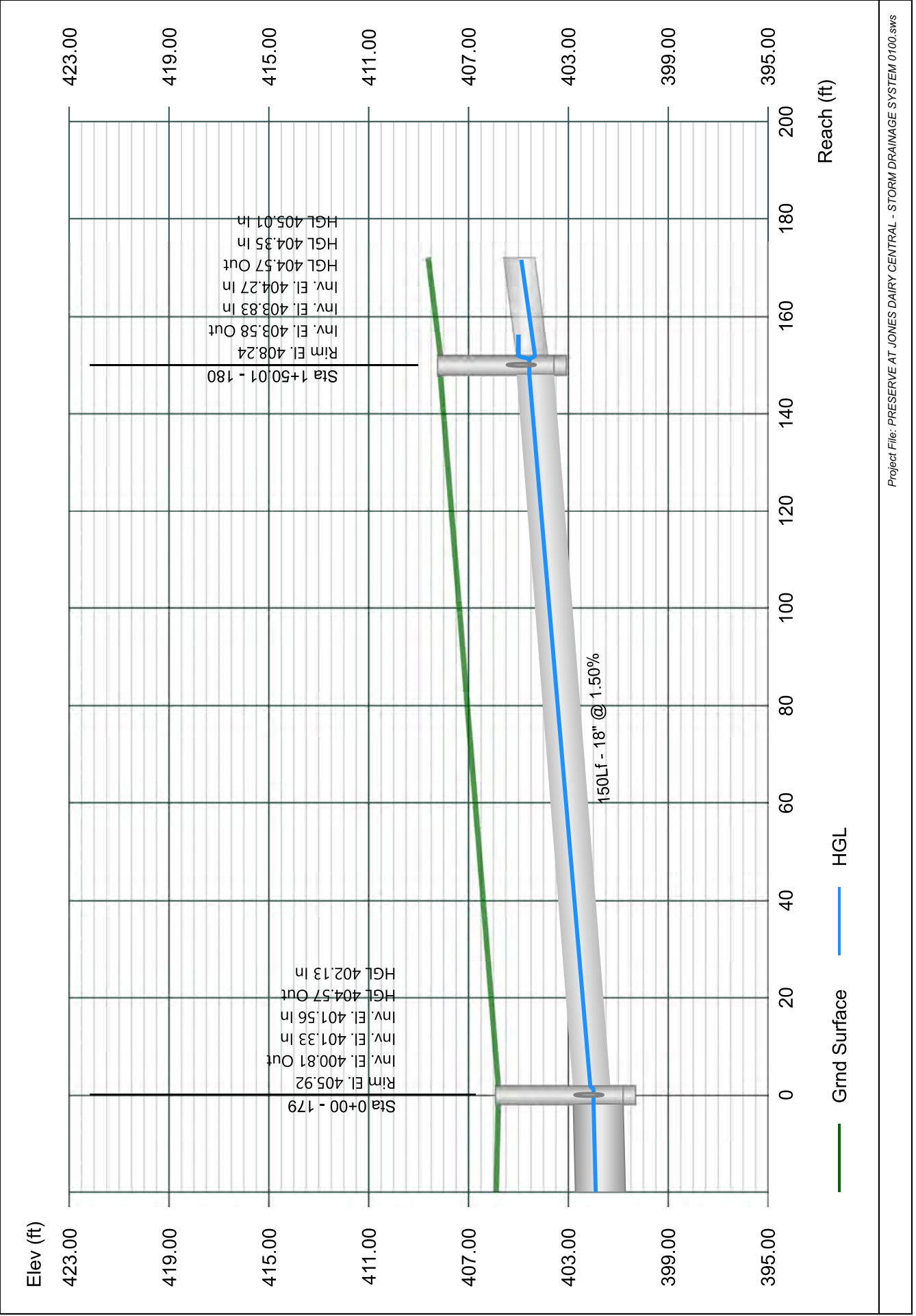

Line 81 - 181 TO 180

Stormwater Studio 2024 v 3.0.0.33

Project Name: Enter Project Name...

01-19-2024

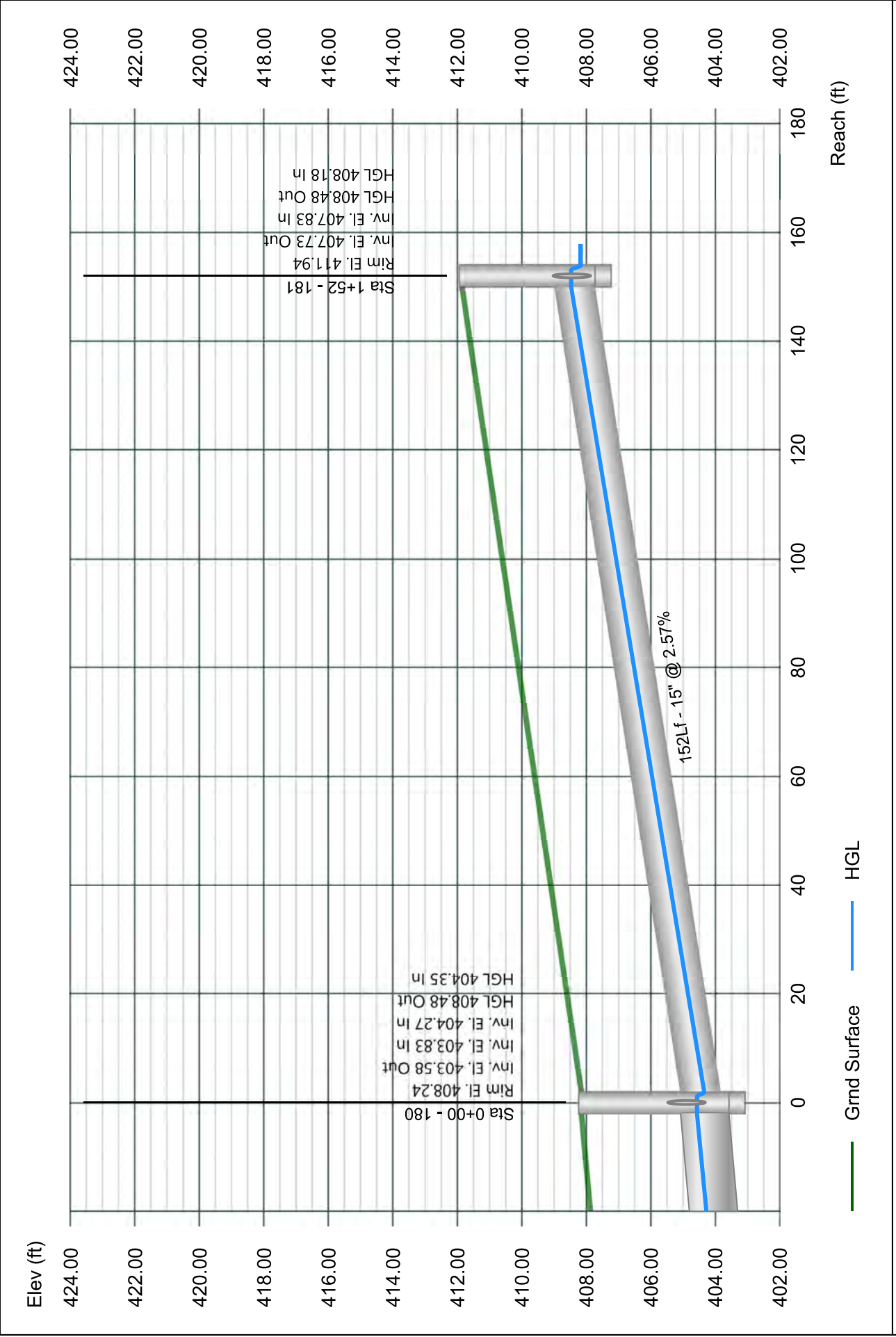

Line 82 - 182 TO 181

Stormwater Studio 2024 v 3.0.0.33

Project Name: Enter Project Name...

01-19-2024

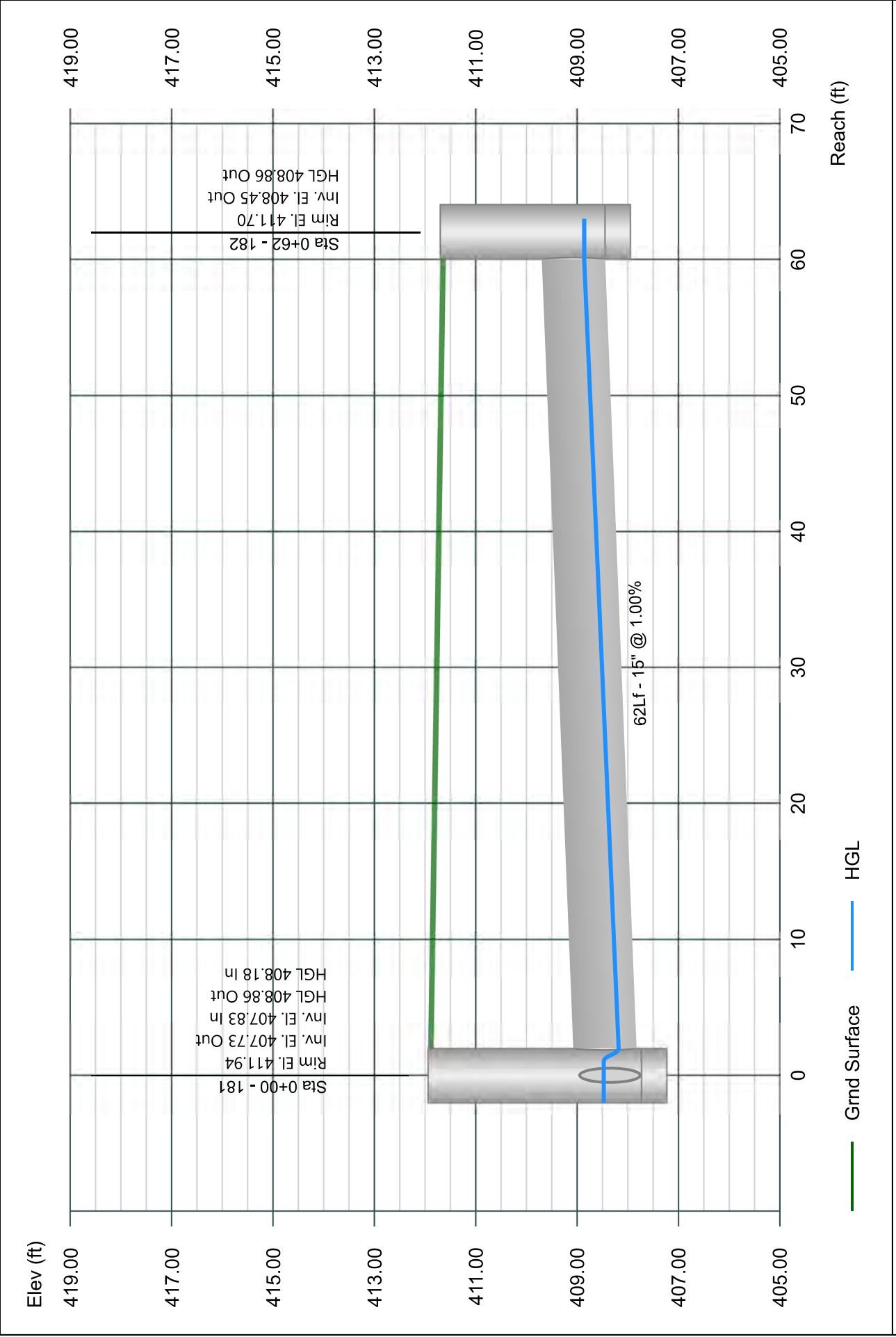

Line 83 - 188 TO 180

Stormwater Studio 2024 v 3.0.0.33

Project Name: Enter Project Name...

01-19-2024

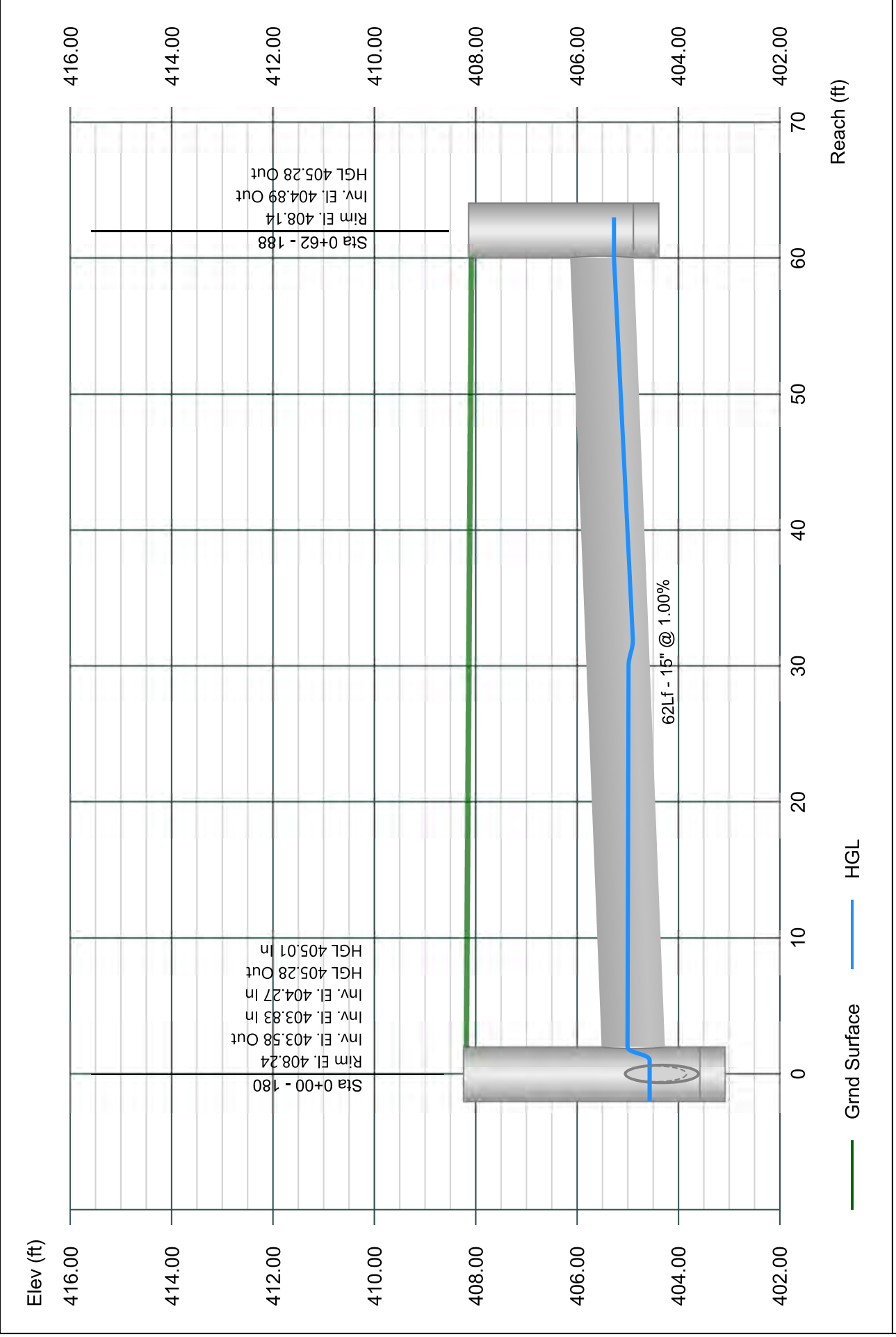

Line 84 - 187 TO 179

Stormwater Studio 2024 v 3.0.0.33

Project Name: Enter Project Name...

01-19-2024

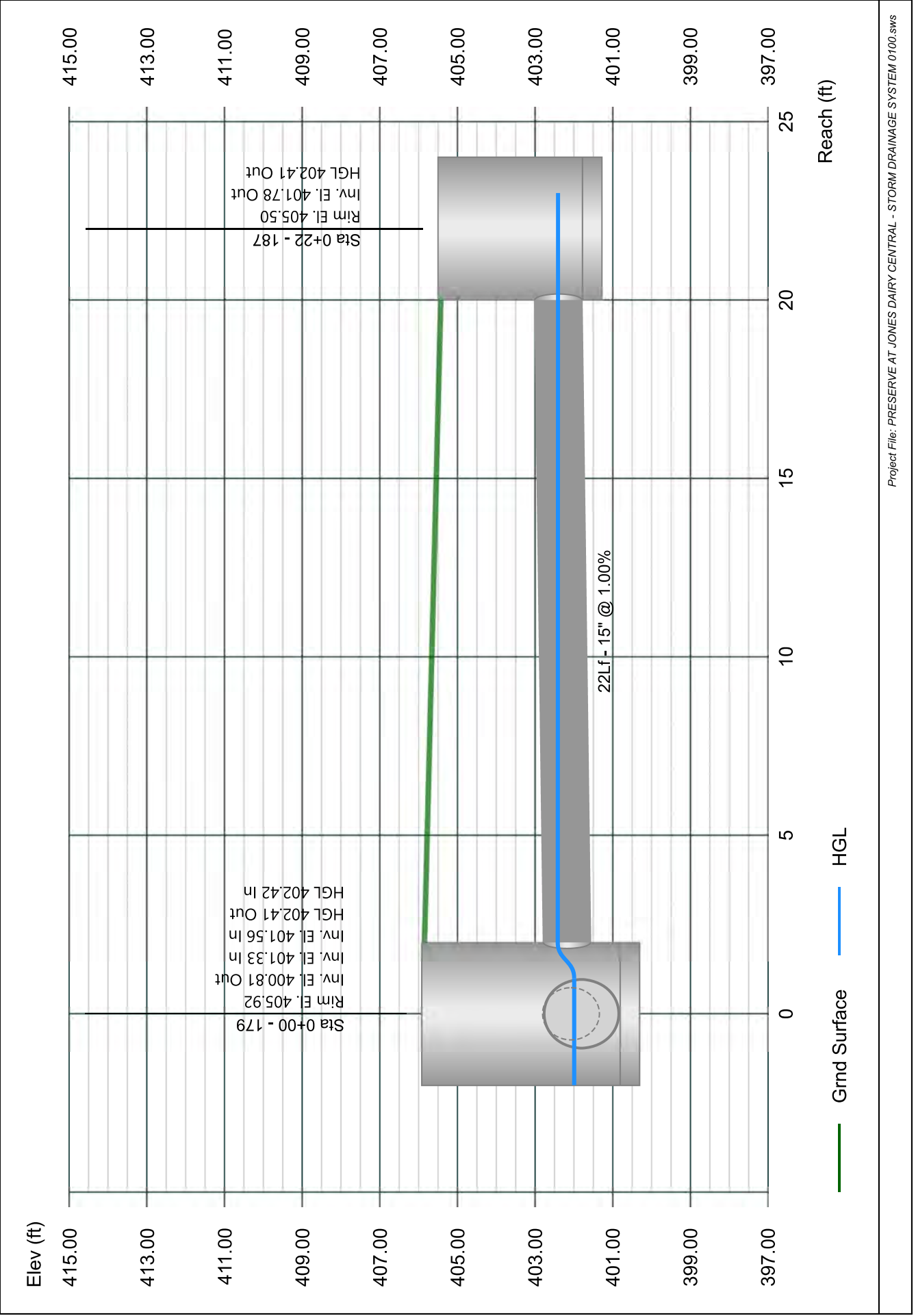

Line 85 - 186 TO 176

Stormwater Studio 2024 v 3.0.0.33

Project Name: Enter Project Name...

01-19-2024

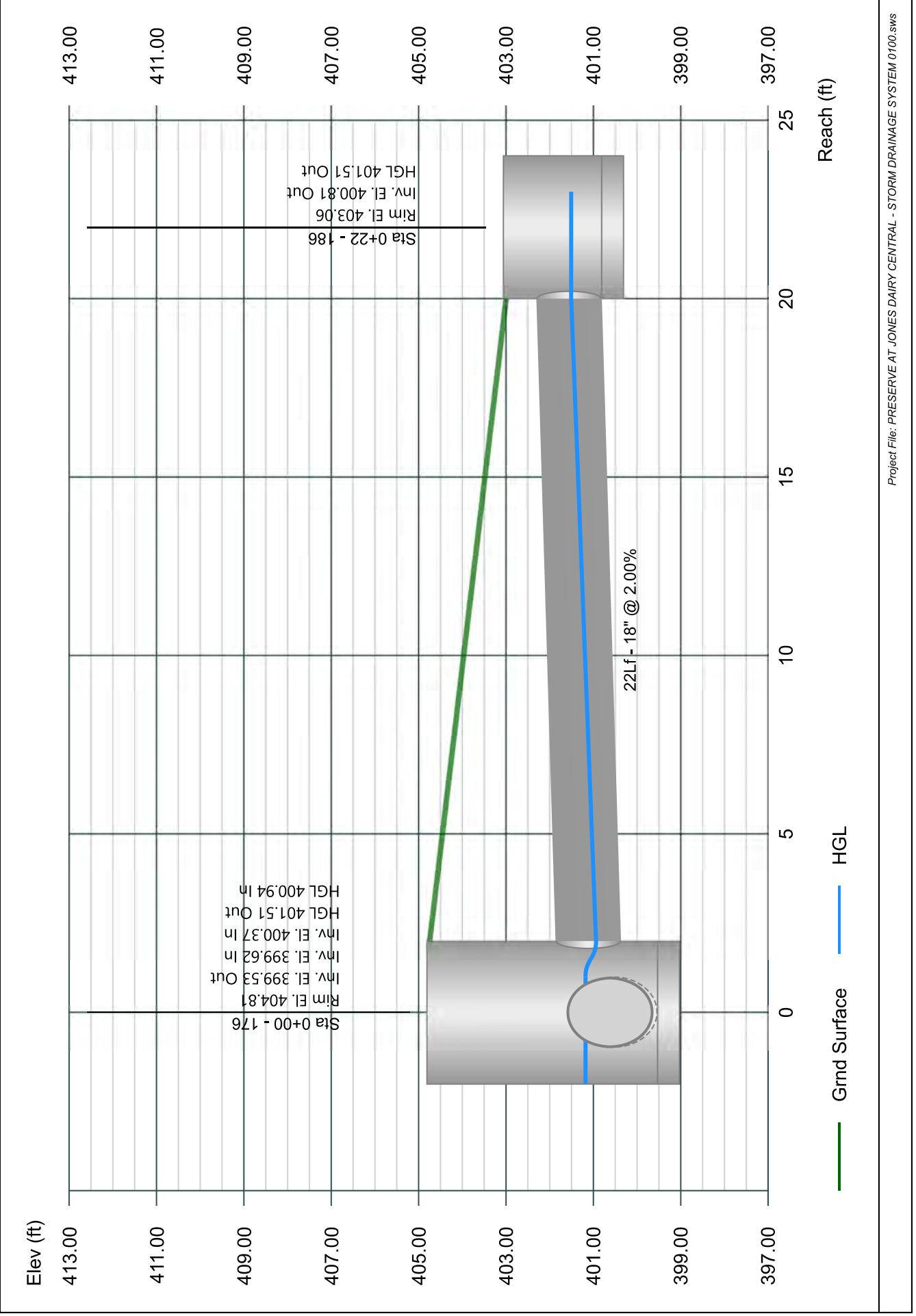

Line 86 - 185 TO 174

Stormwater Studio 2024 v 3.0.0.33

Project Name: Enter Project Name...

01-19-2024

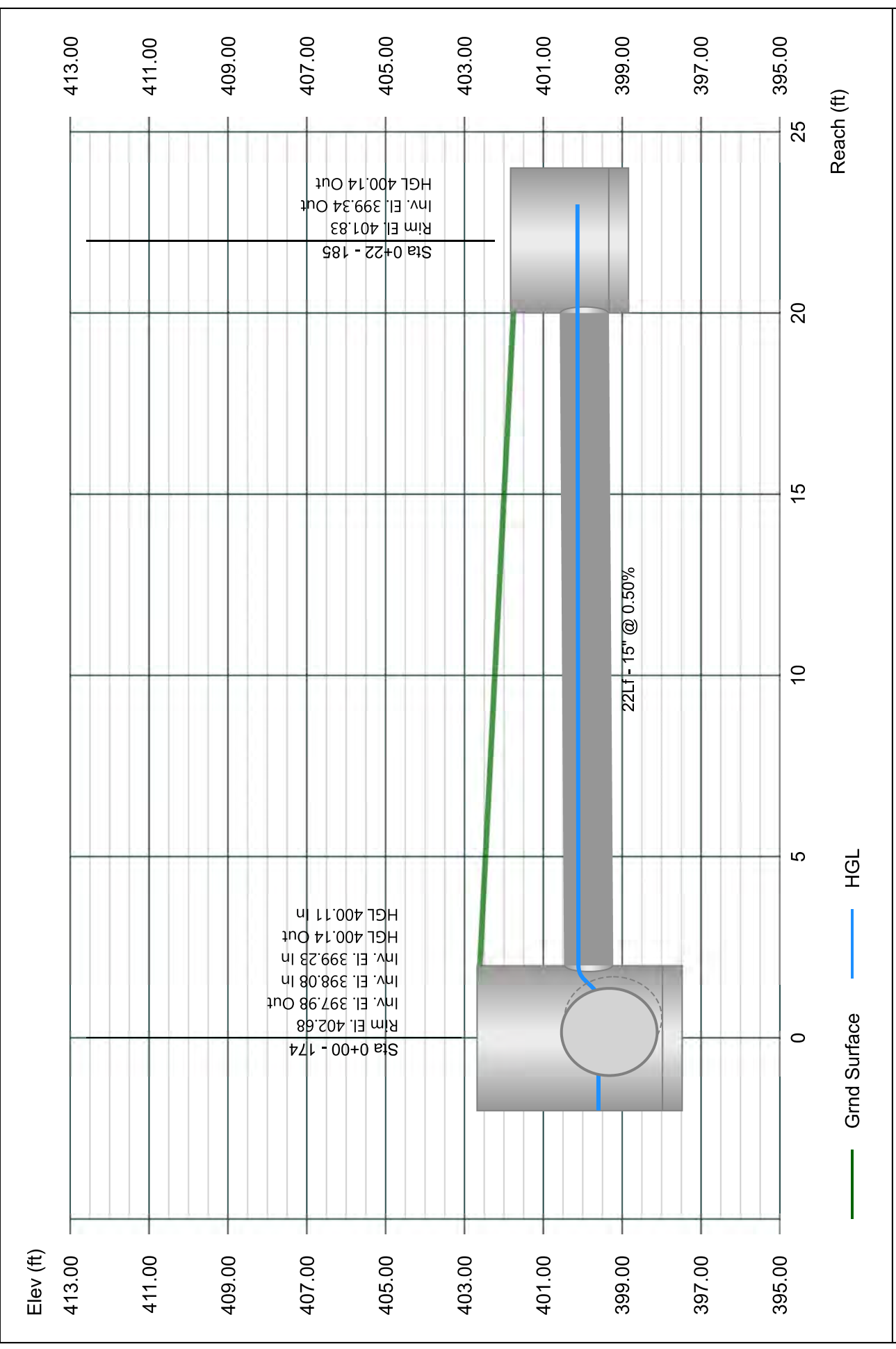

Line 87 - 184 TO 173

Stormwater Studio 2024 v 3.0.0.33

Project Name: Enter Project Name...

01-19-2024

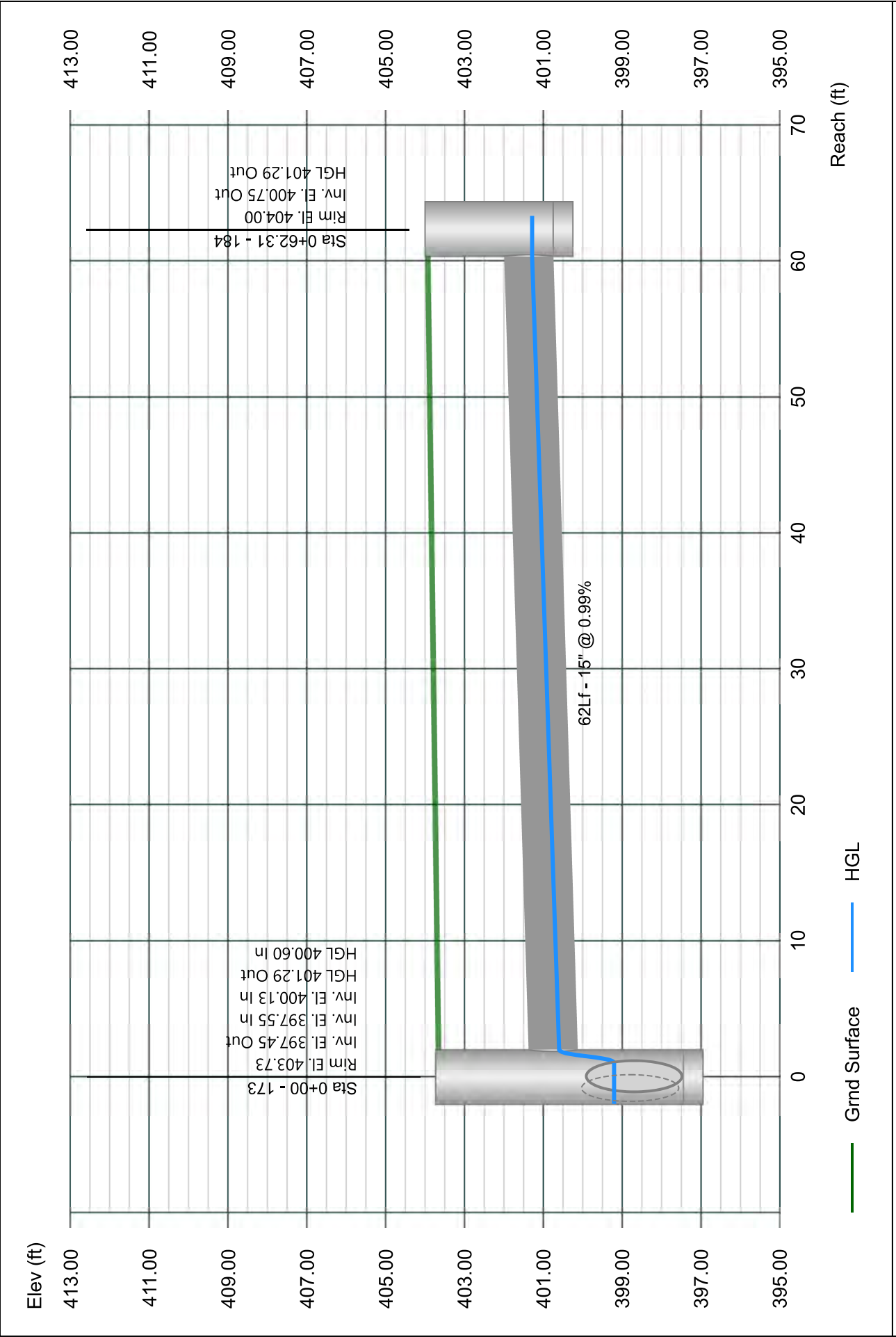

Line 88 - 183 TO 172

Stormwater Studio 2024 v 3.0.0.33

Project Name: Enter Project Name...

01-19-2024

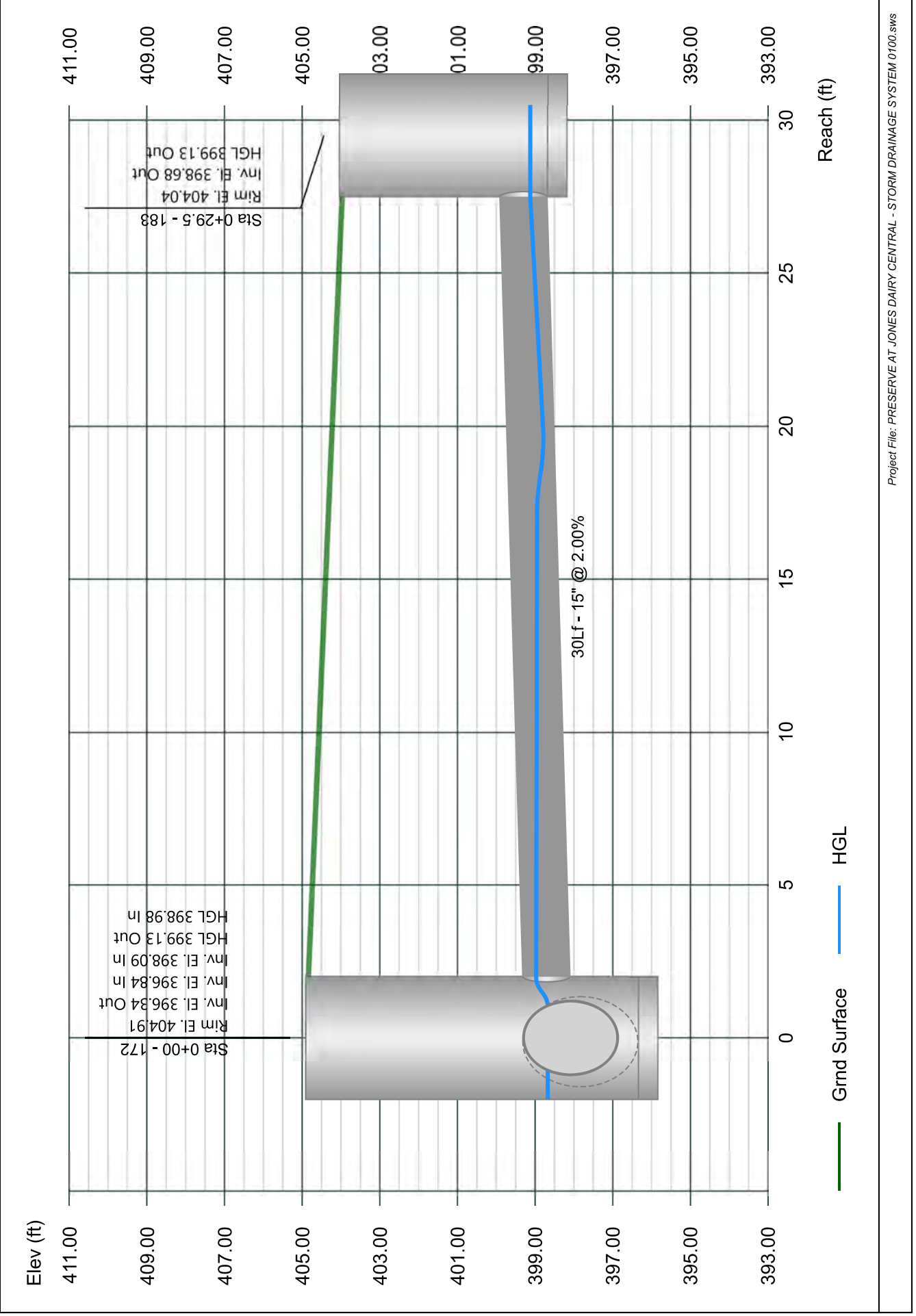

Line 89 - 189 TO 171

Stormwater Studio 2024 v 3.0.0.33

Project Name: Enter Project Name...

01-19-2024

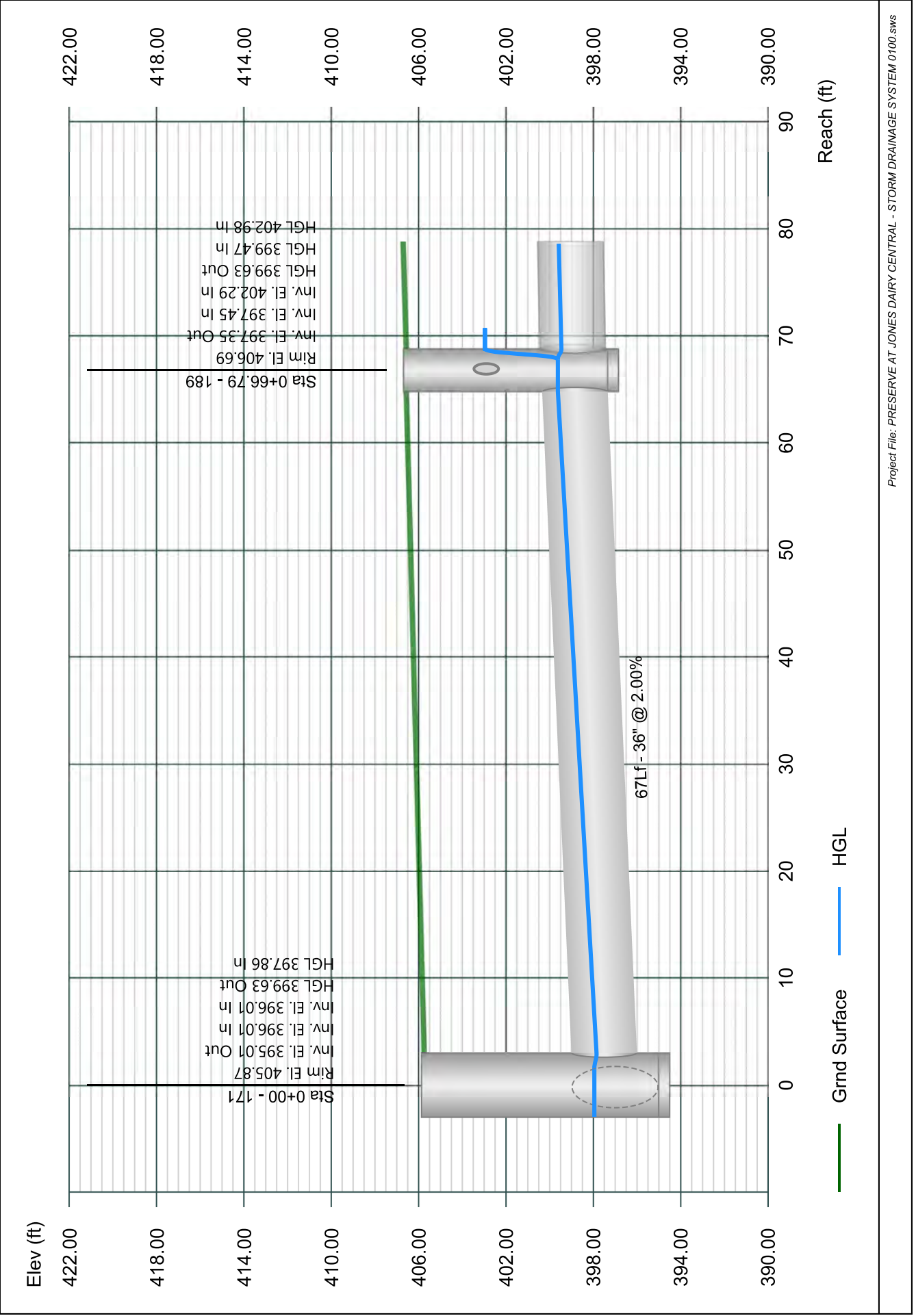

Line 90 - 190 TO 189

Stormwater Studio 2024 v 3.0.0.33

Project Name: Enter Project Name...

01-19-2024

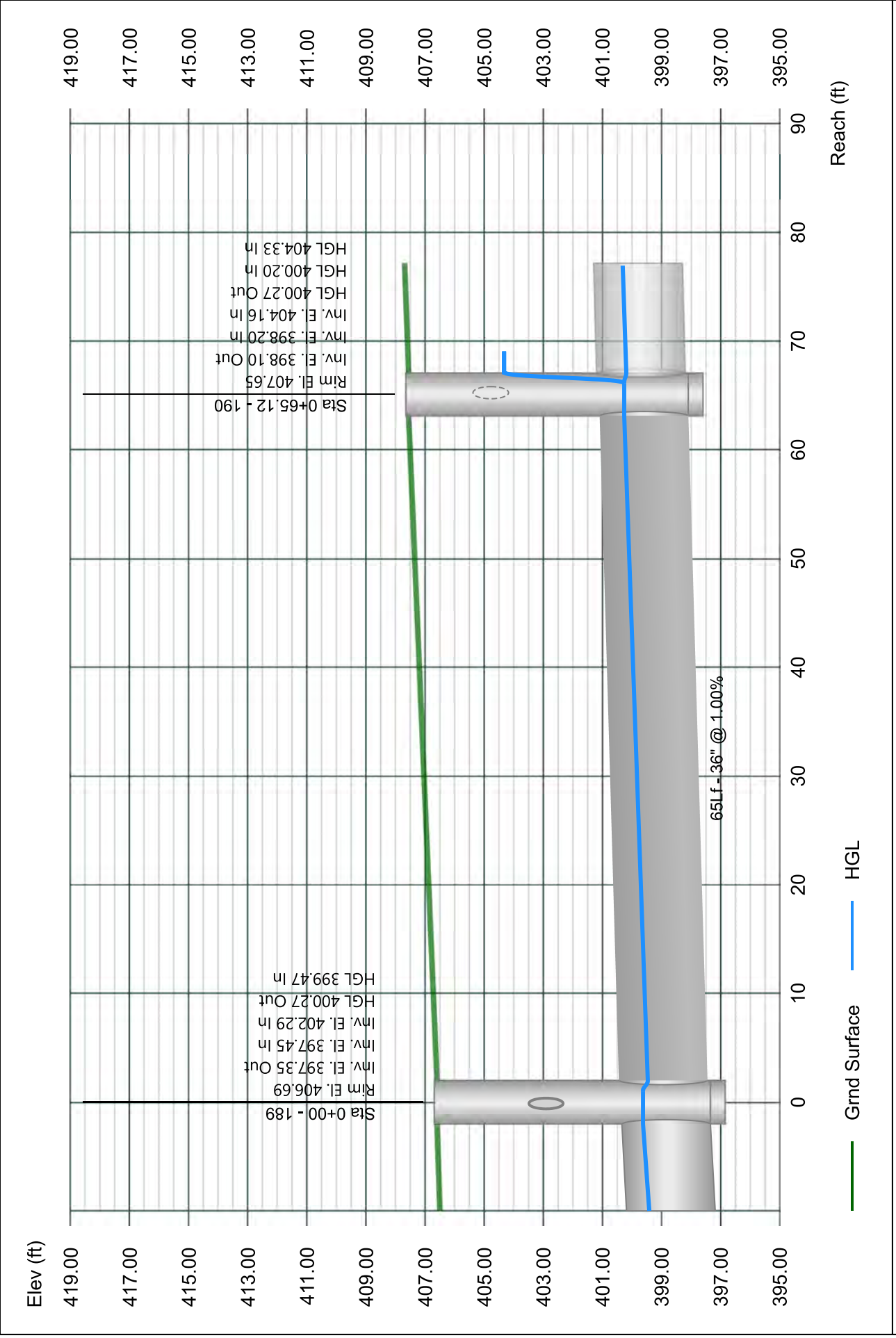

Line 91 - 191 TO 190

Stormwater Studio 2024 v 3.0.0.33

Project Name: Enter Project Name...

01-19-2024

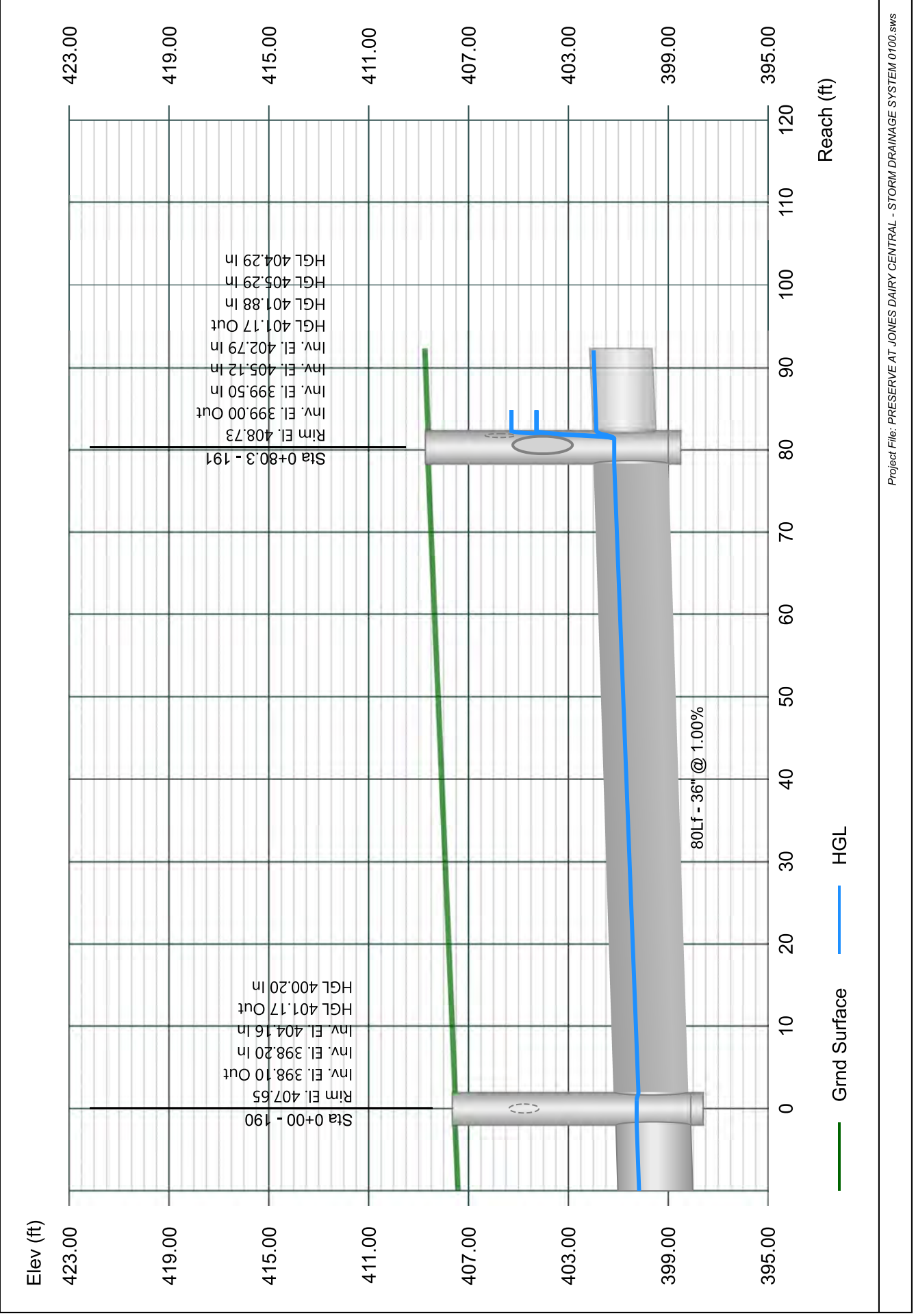

Line 92 - 192 TO 191

Stormwater Studio 2024 v 3.0.0.33

Project Name: Enter Project Name...

01-19-2024

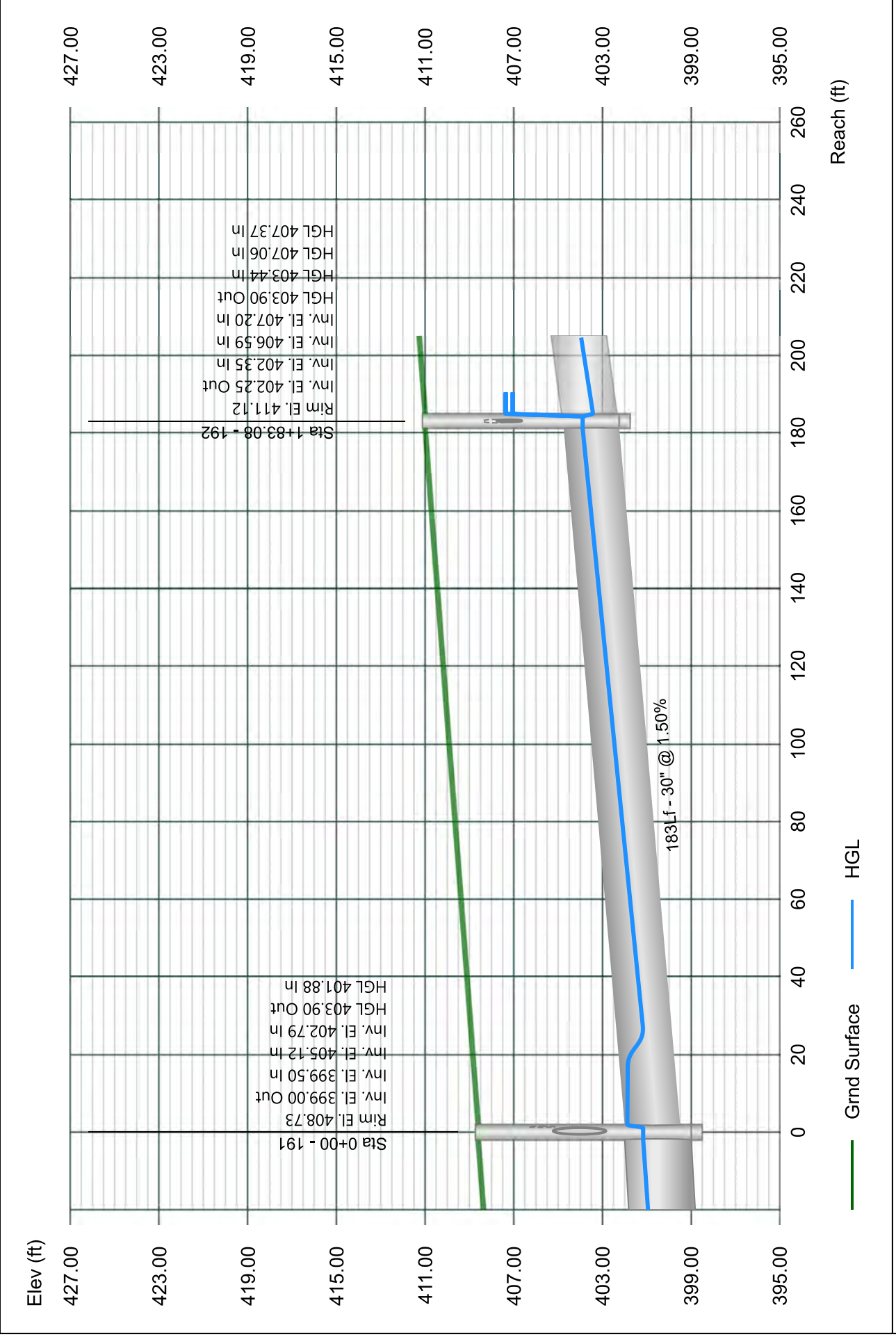

Line 93 - 193 TO 192

Stormwater Studio 2024 v 3.0.0.33

Project Name: Enter Project Name...

01-19-2024

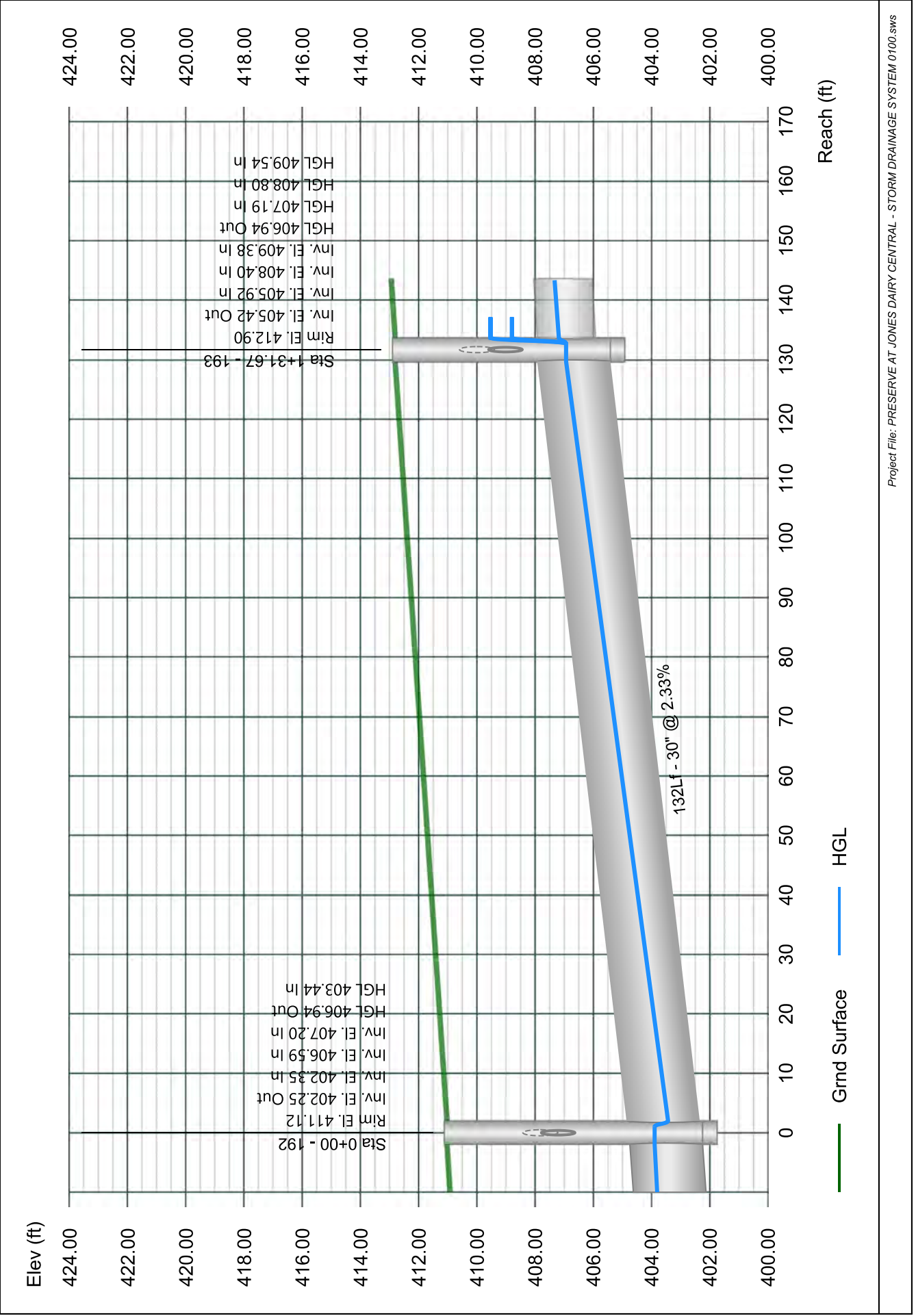

Line 94 - 194 TO 193

Stormwater Studio 2024 v 3.0.0.33

Project Name: Enter Project Name...

01-19-2024

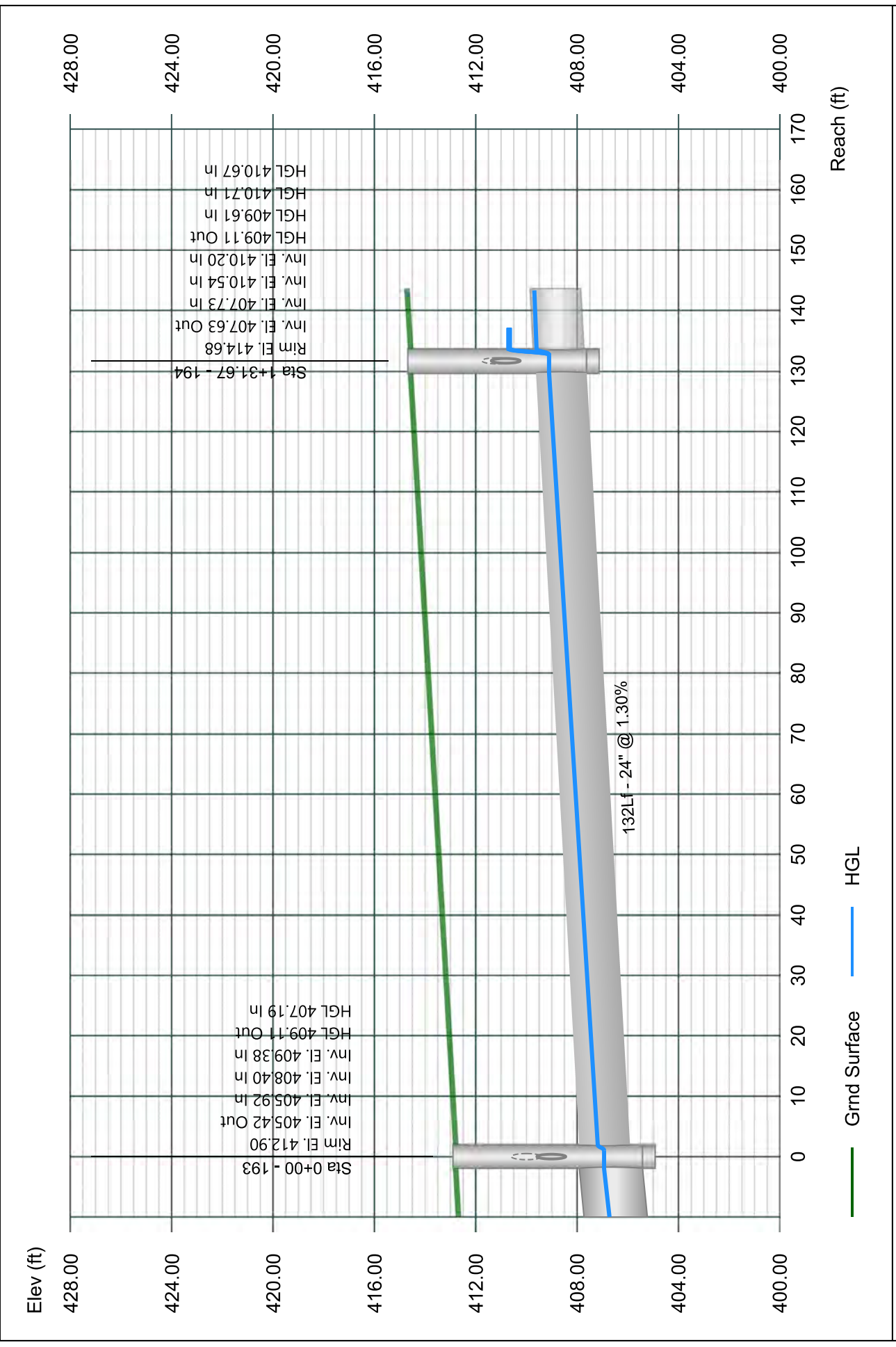

Line 95 - 195 TO 194

Stormwater Studio 2024 v 3.0.0.33

Project Name: Enter Project Name...

01-19-2024

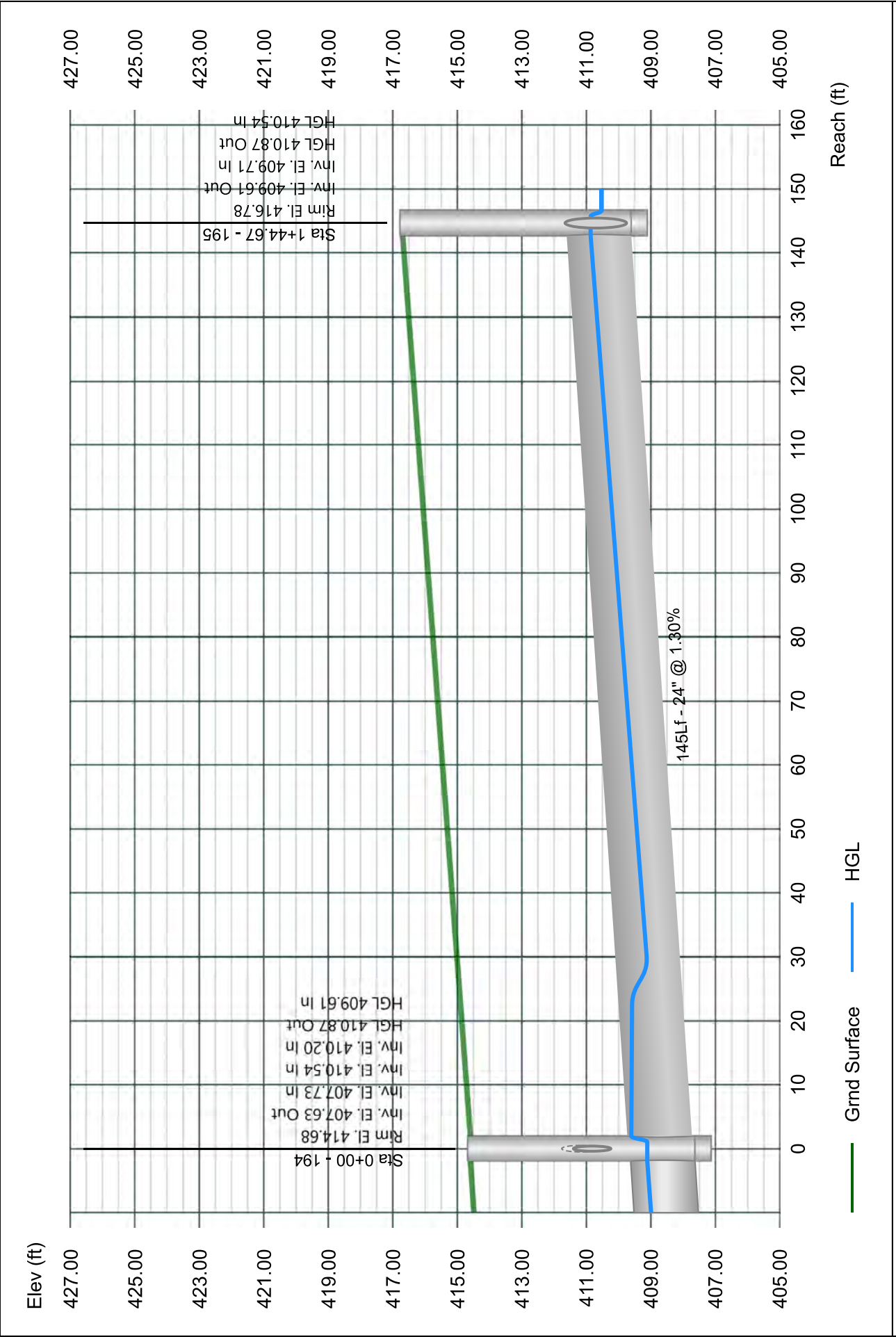

Line 96 - 196 TO 195

Stormwater Studio 2024 v 3.0.0.33

Project Name: Enter Project Name...

01-19-2024

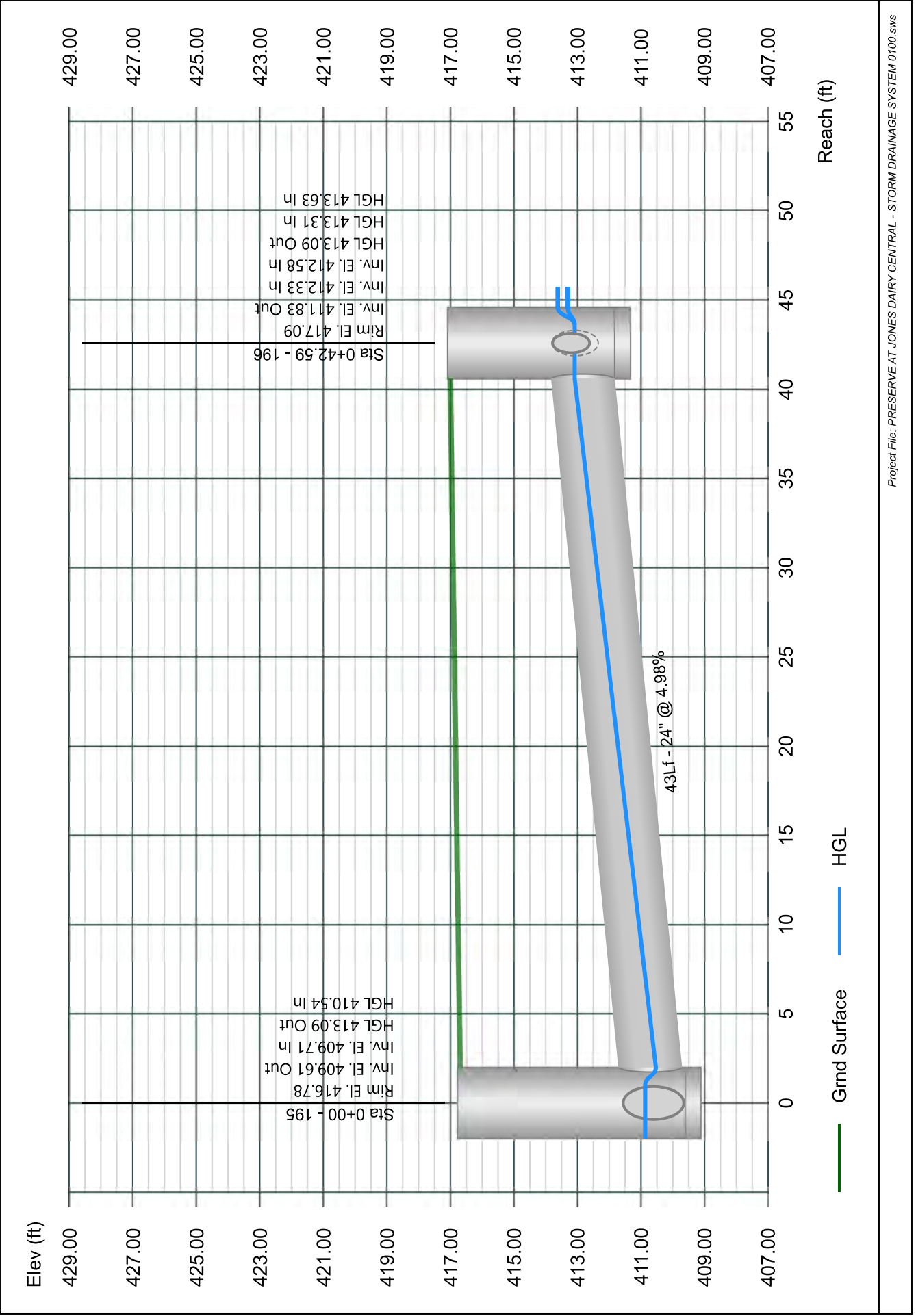

Line 97 - 197 TO 196

Stormwater Studio 2024 v 3.0.0.33

Project Name: Enter Project Name...

01-19-2024

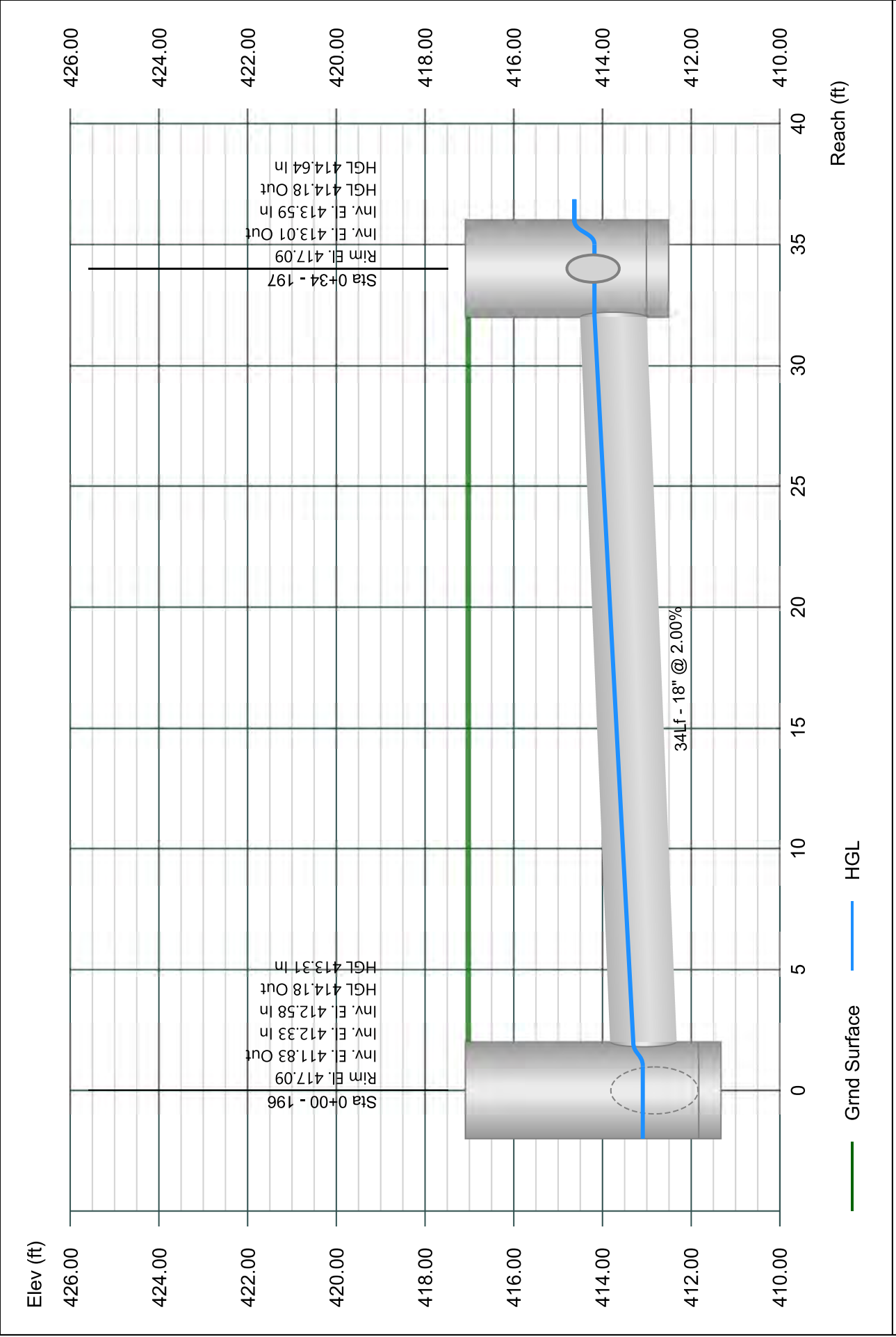

Line 98 - 198 TO 197

Stormwater Studio 2024 v 3.0.0.33

Project Name: Enter Project Name...

01-19-2024

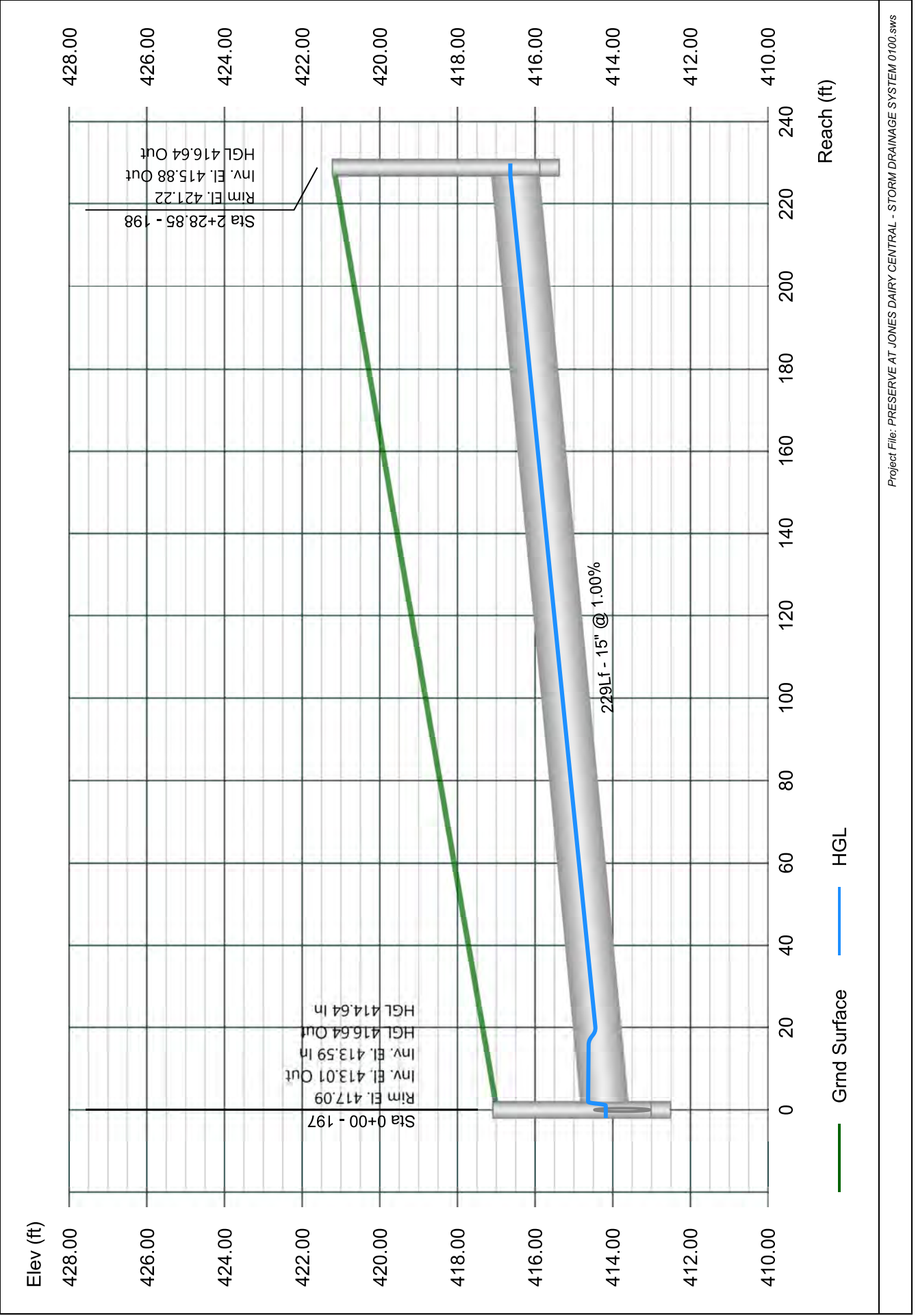

Line 99 - 199 TO 196

Stormwater Studio 2024 v 3.0.0.33

Project Name: Enter Project Name...

01-19-2024

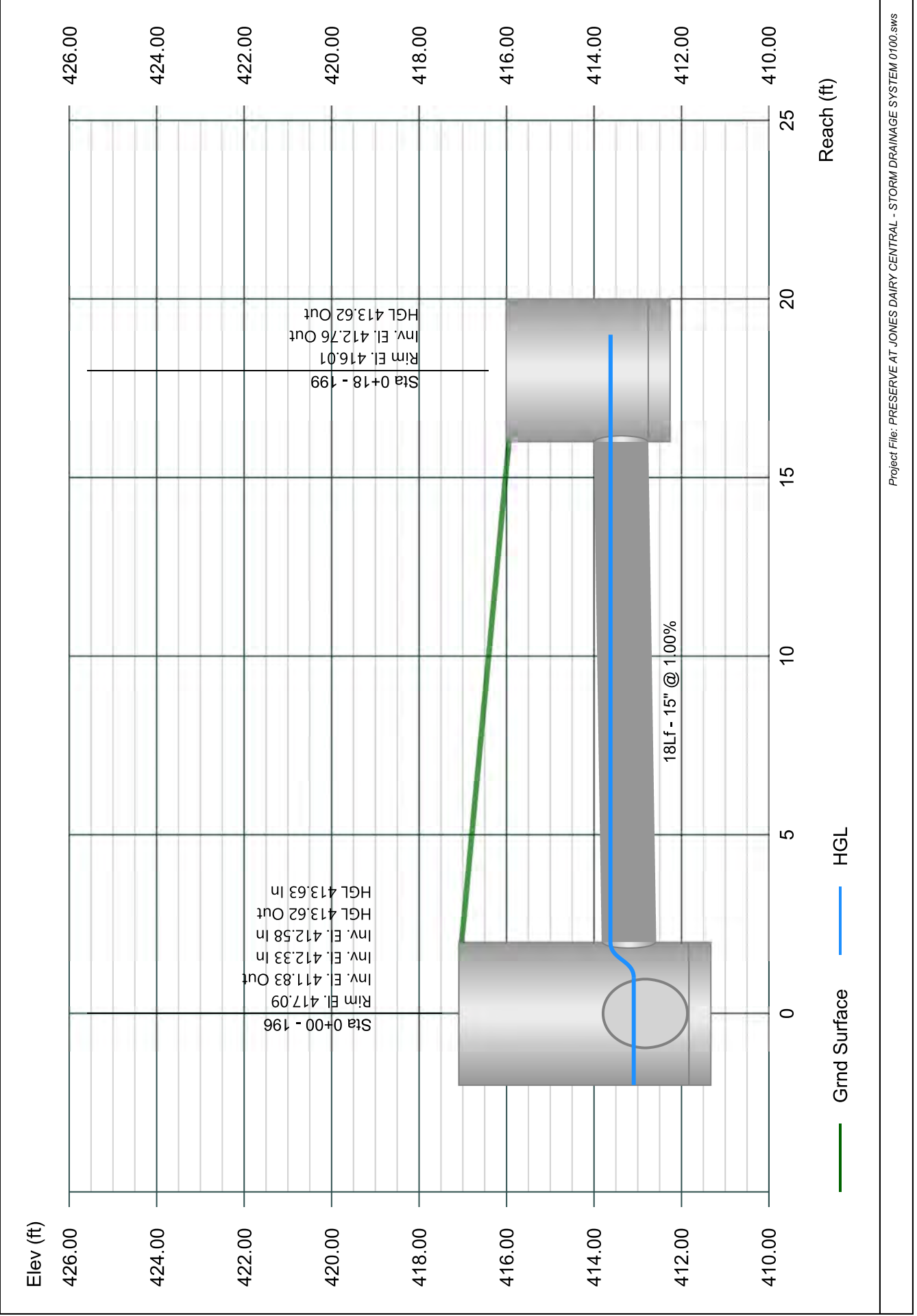

Line 100 - 200 TO 194

Stormwater Studio 2024 v 3.0.0.33

Project Name: Enter Project Name...

01-19-2024

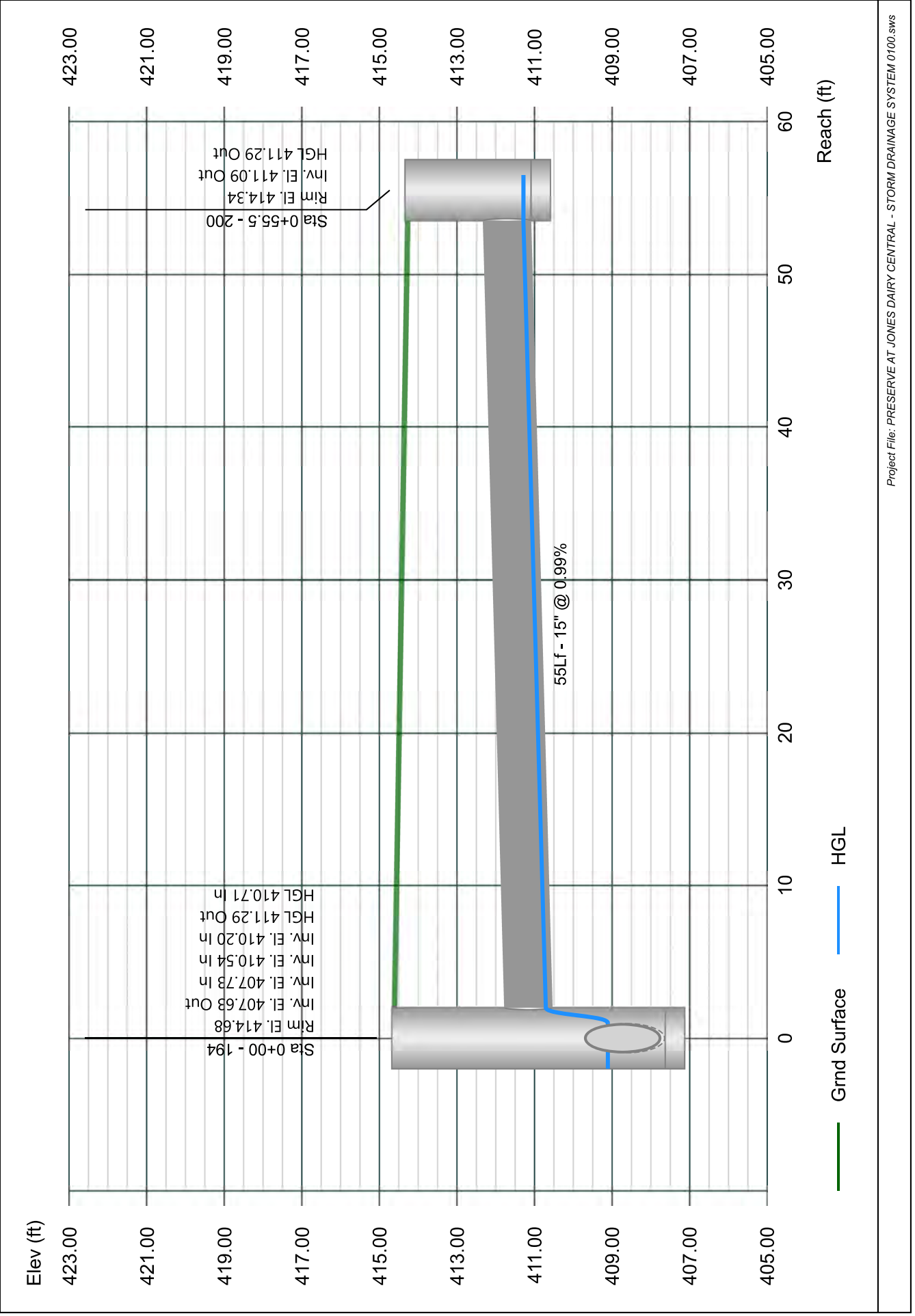

Line 101 - 201 TO 194

Stormwater Studio 2024 v 3.0.0.33

Project Name: Enter Project Name...

01-19-2024

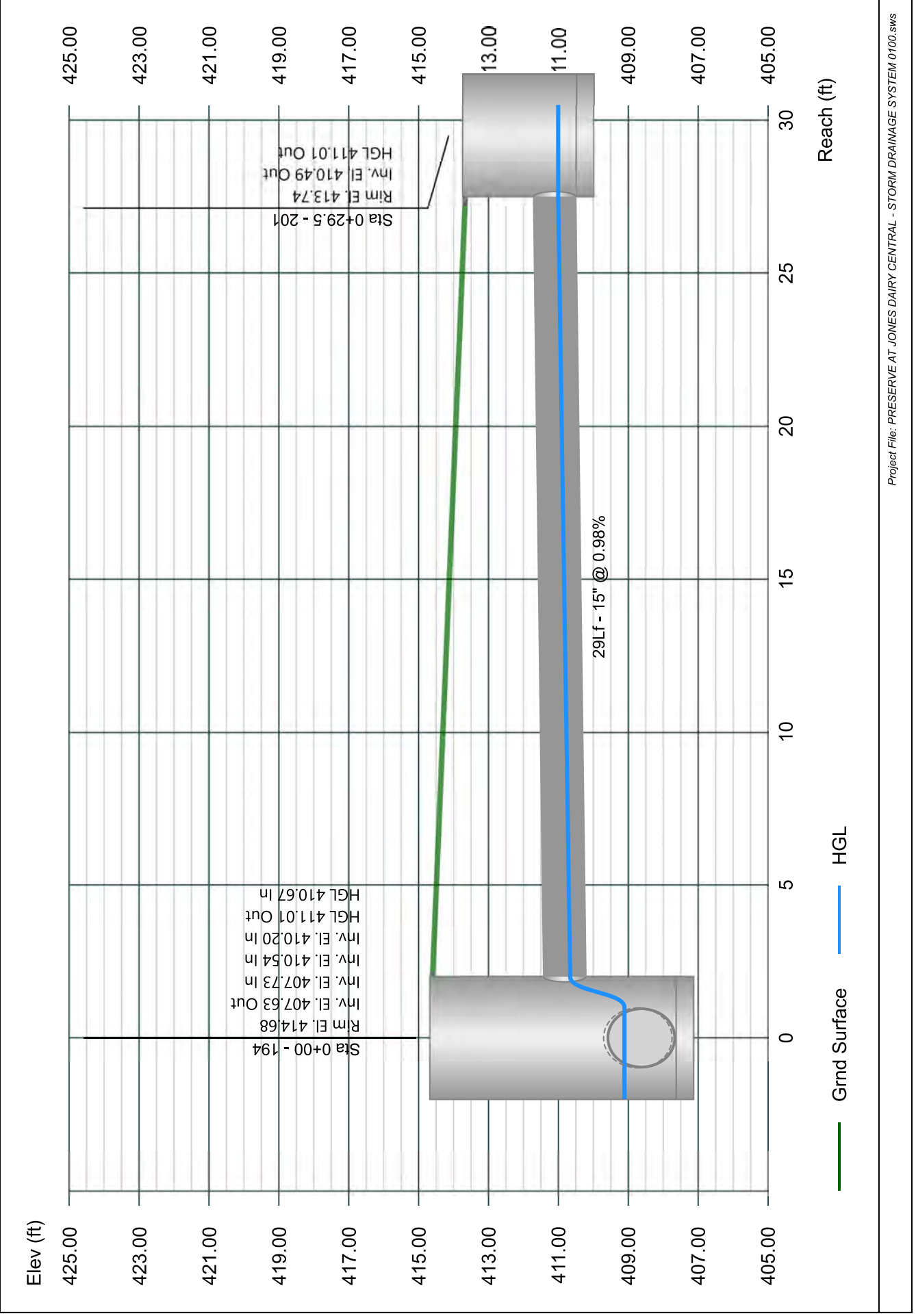

Line 102 - 202 TO 193

Stormwater Studio 2024 v 3.0.0.33

Project Name: Enter Project Name...

01-19-2024

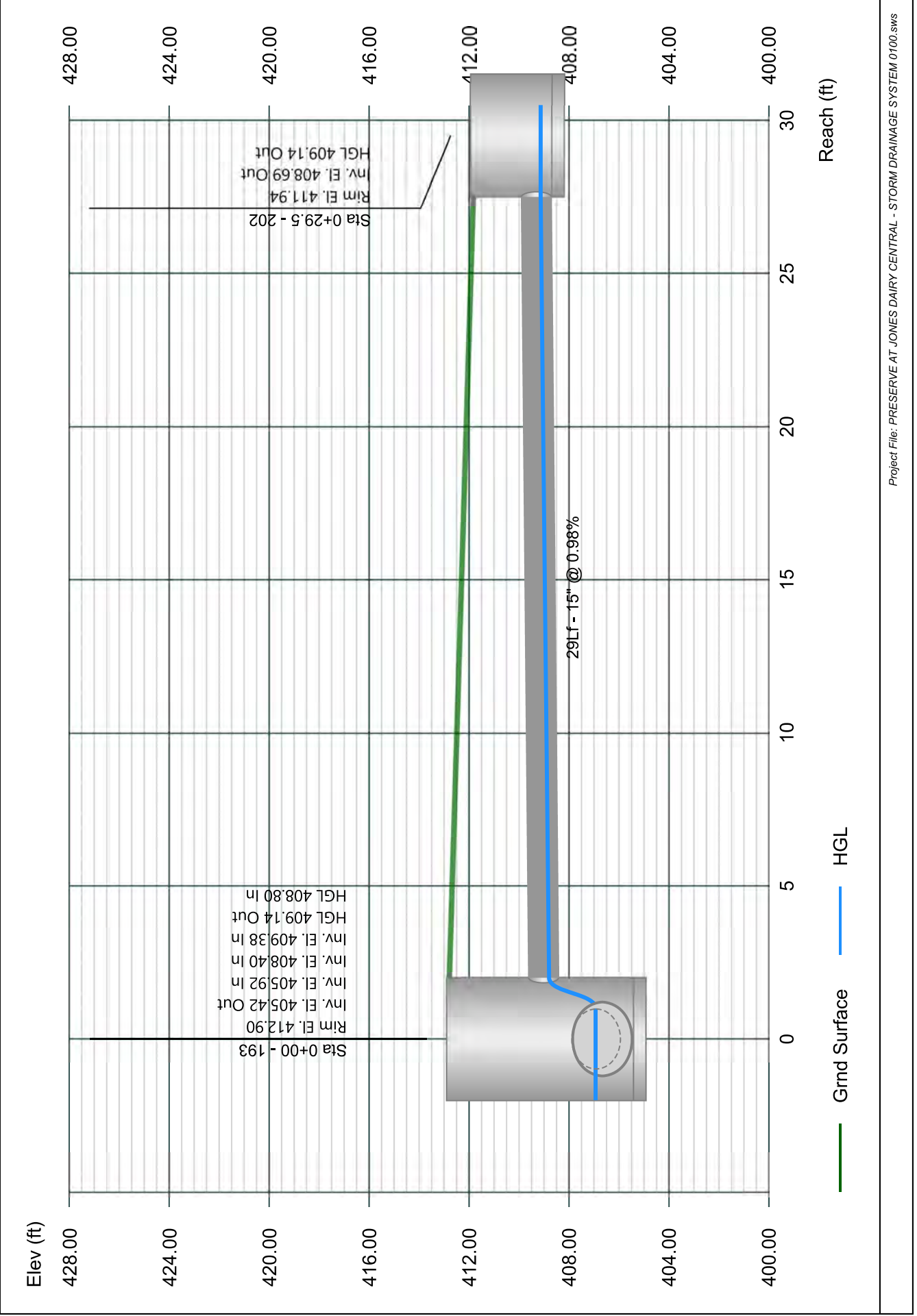

Line 103 - 203 TO 193

Stormwater Studio 2024 v 3.0.0.33

Project Name: Enter Project Name...

01-19-2024

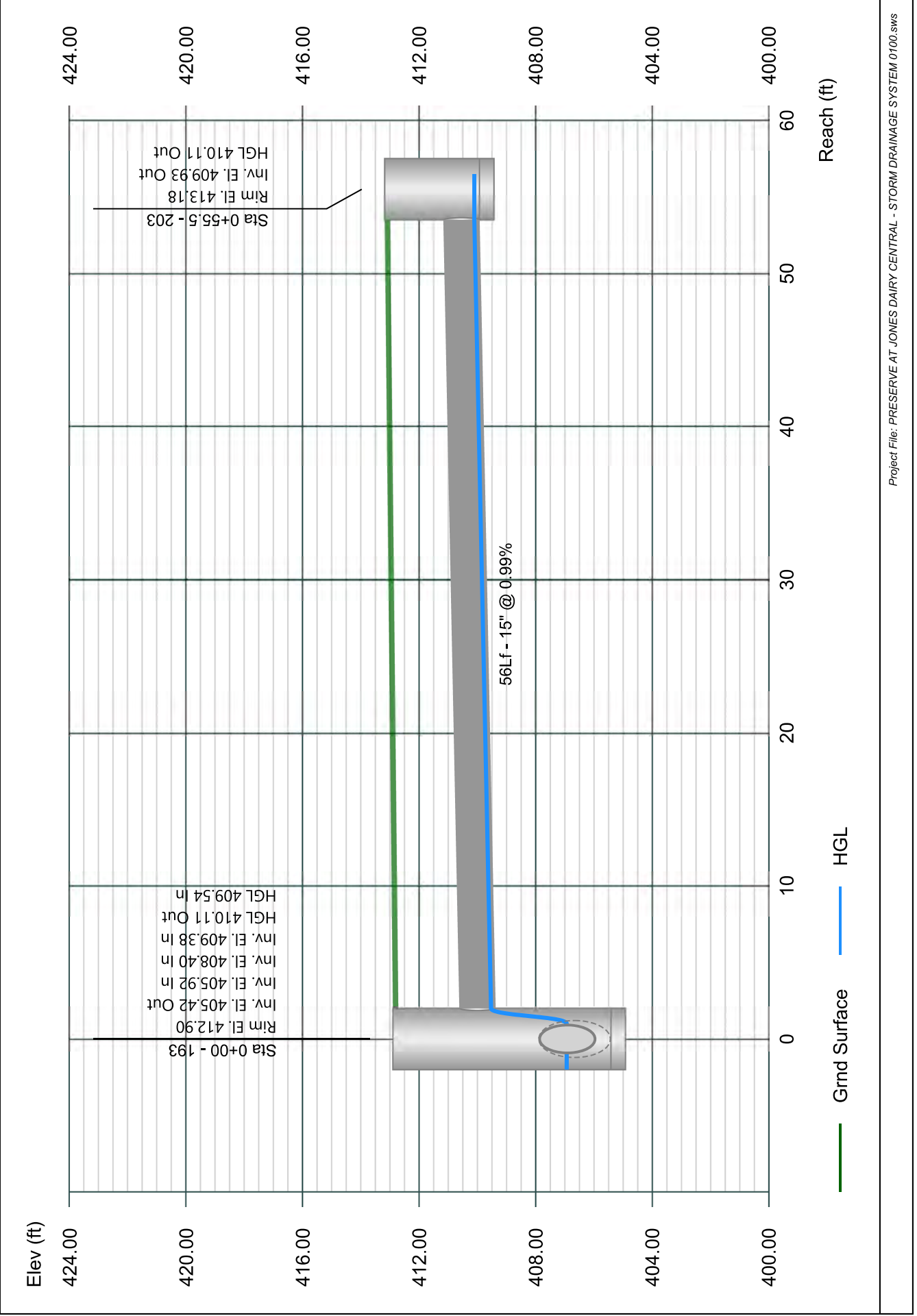

Line 104 - 204 TO 192

Stormwater Studio 2024 v 3.0.0.33

Project Name: Enter Project Name...

01-19-2024

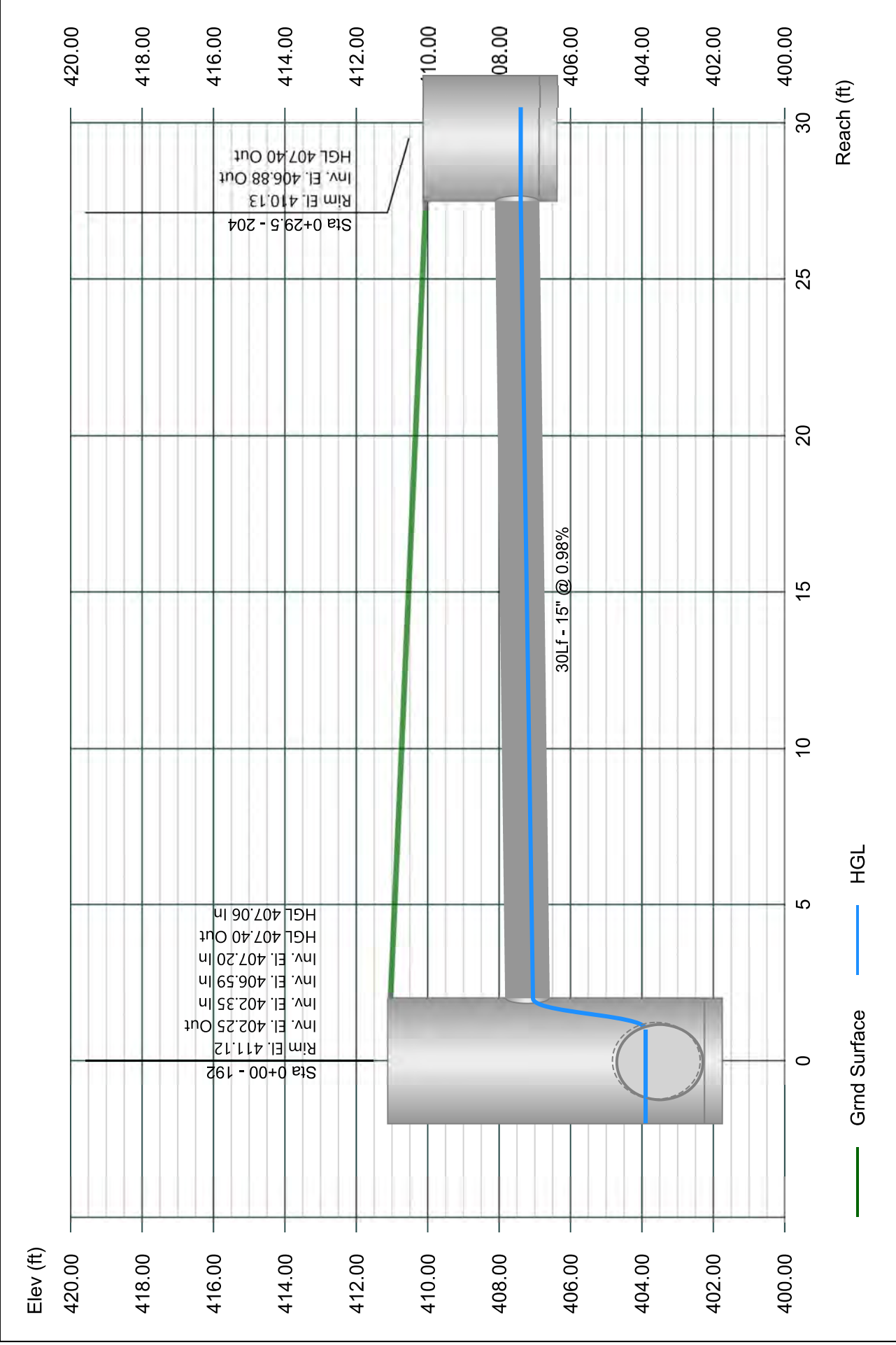

Line 105 - 205 TO 192

Stormwater Studio 2024 v 3.0.0.33

Project Name: Enter Project Name...

01-19-2024

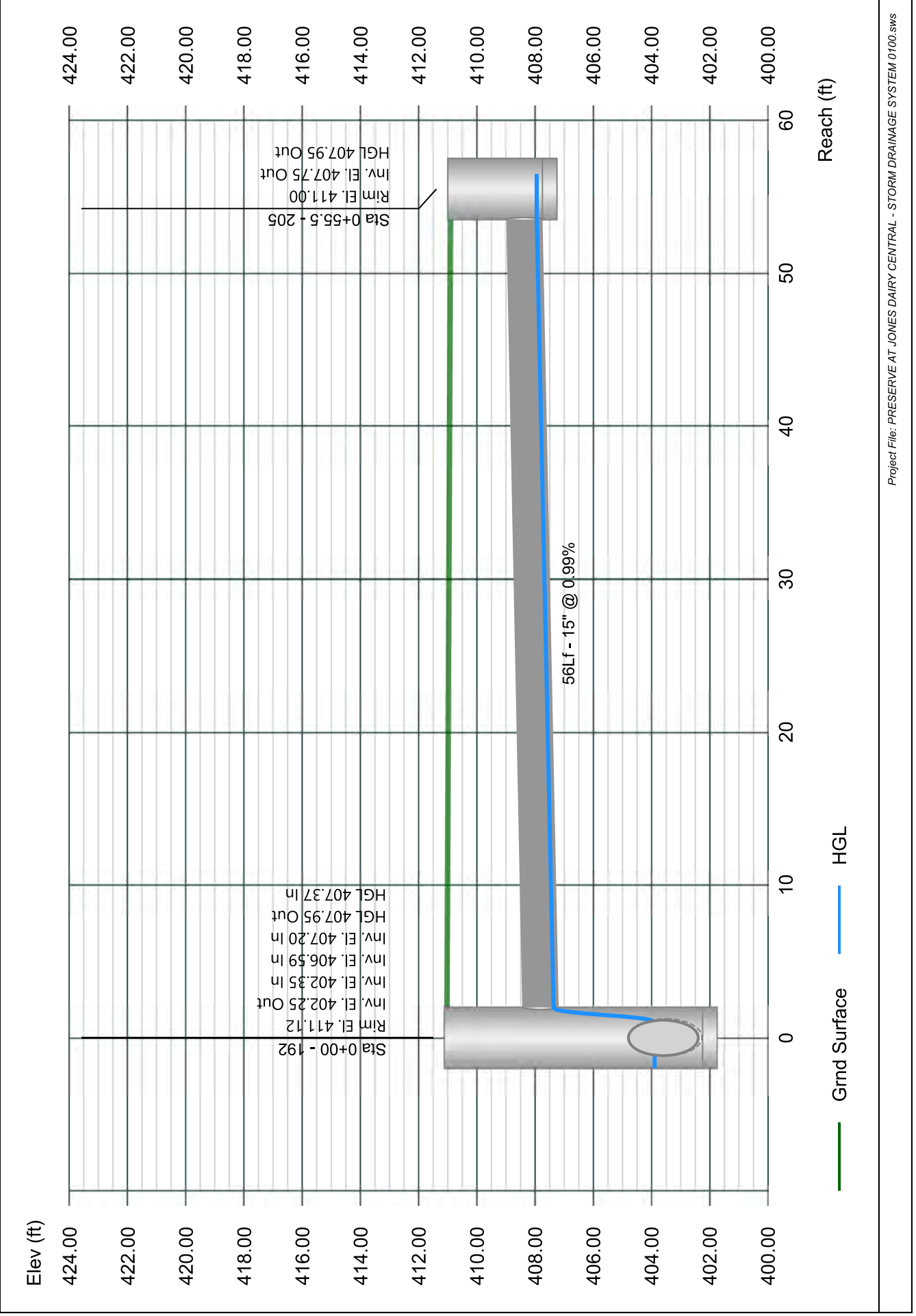

Line 106 - 206 TO 191

Stormwater Studio 2024 v 3.0.0.33

Project Name: Enter Project Name...

01-19-2024

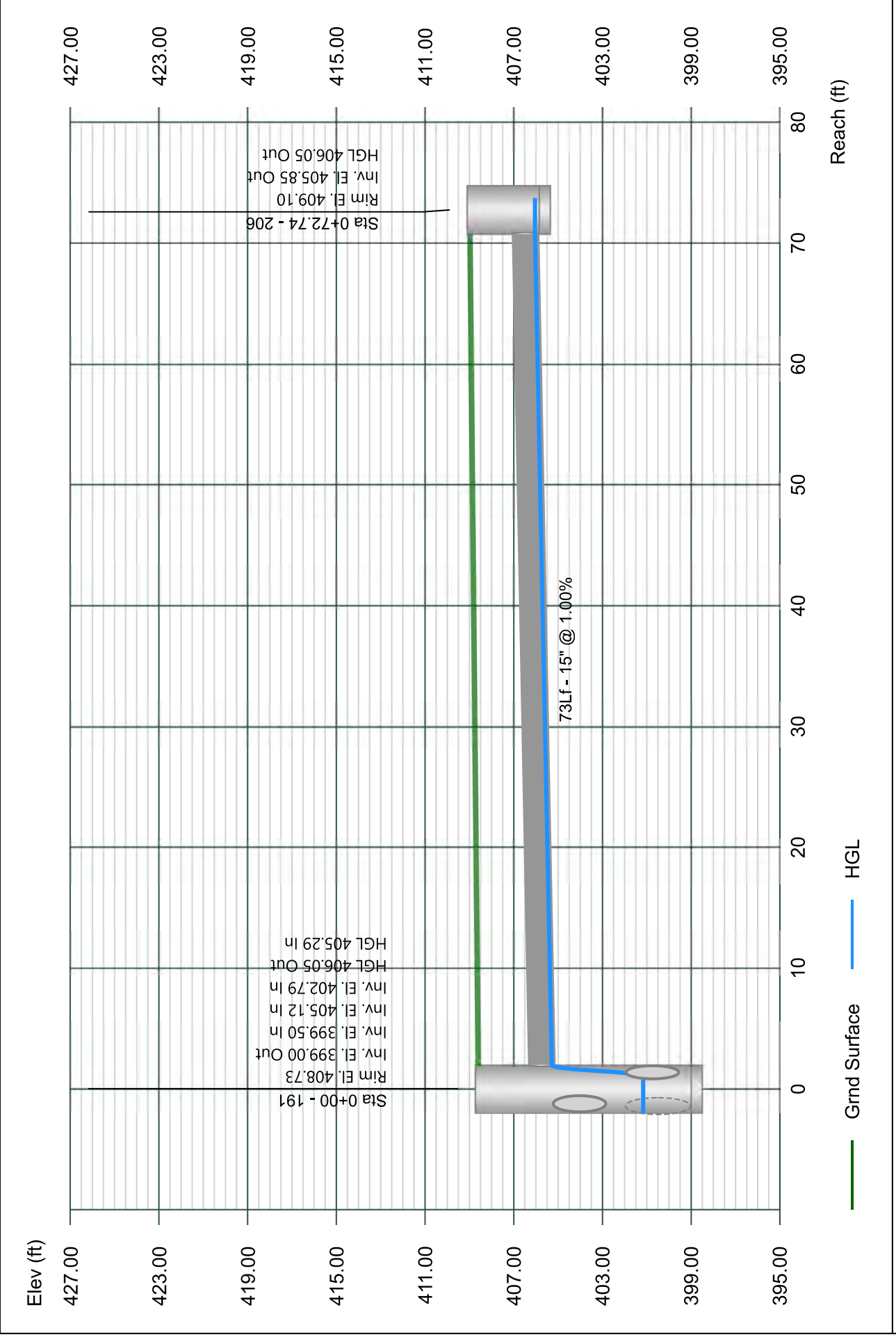

Line 107 - 207 TO 191

Stormwater Studio 2024 v 3.0.0.33

Project Name: Enter Project Name...

01-19-2024

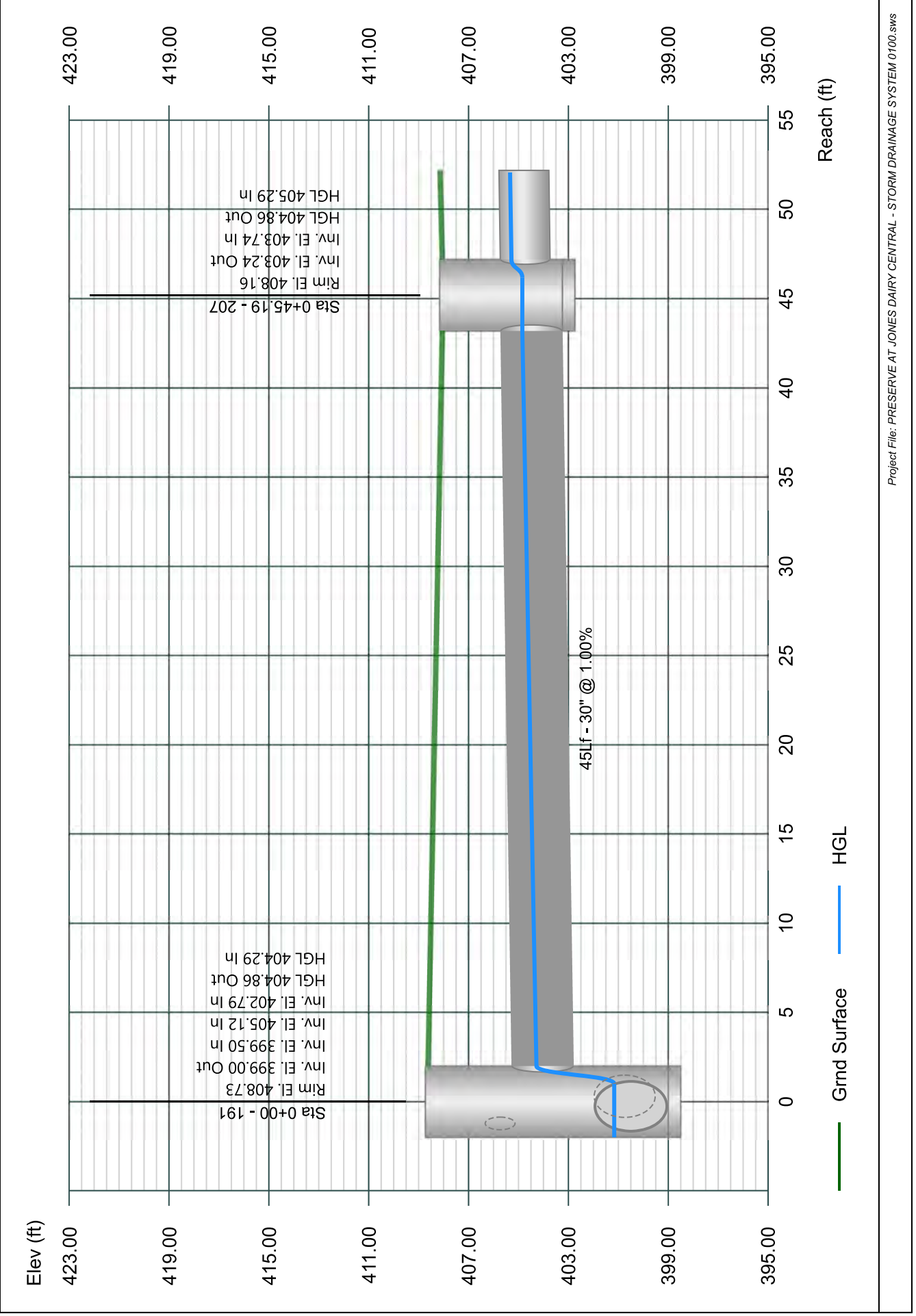

Line 108 - 208 TO 207

Stormwater Studio 2024 v 3.0.0.33

Project Name: Enter Project Name...

01-19-2024

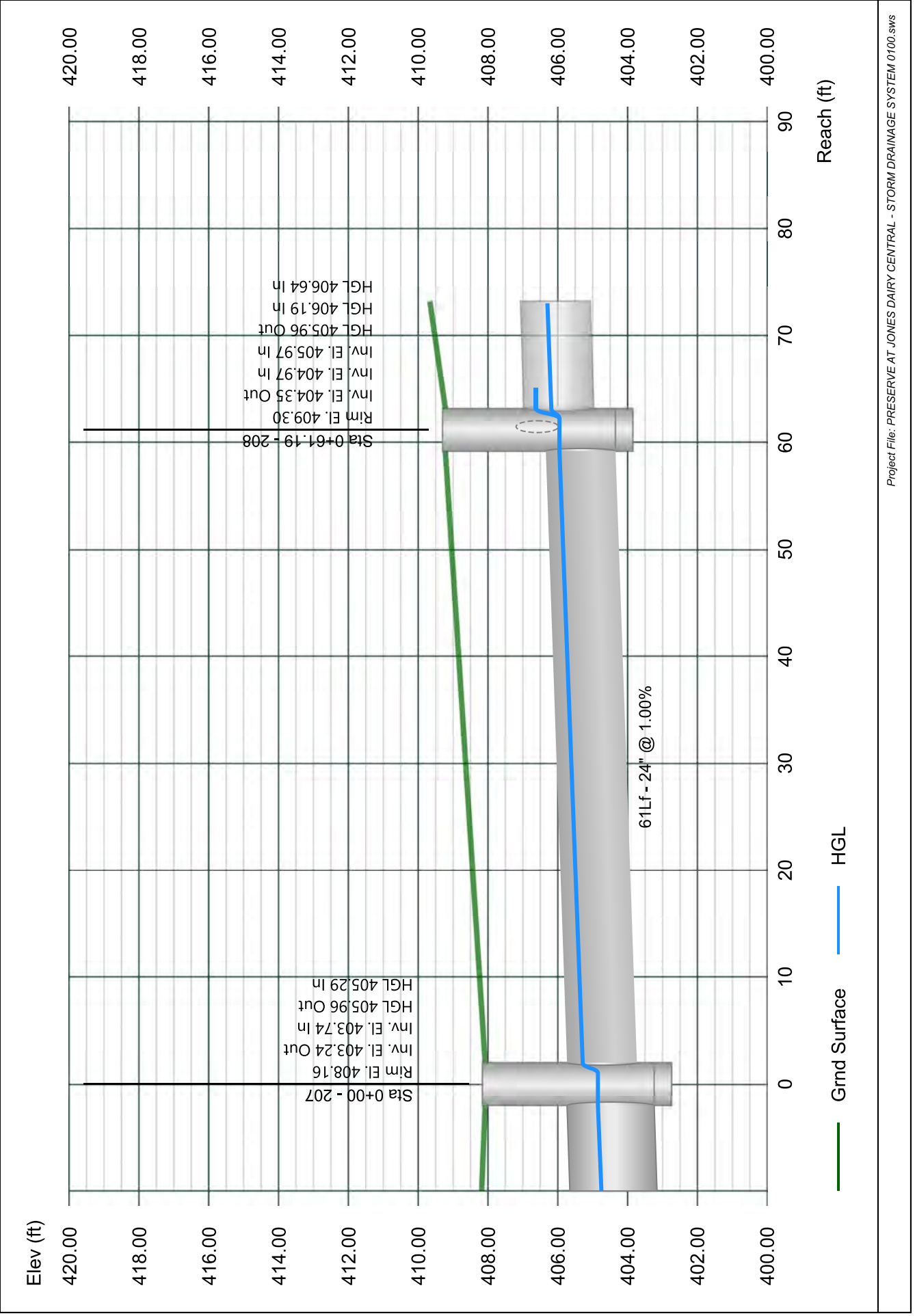

Line 109 - 209 TO 208

Stormwater Studio 2024 v 3.0.0.33

Project Name: Enter Project Name...

01-19-2024

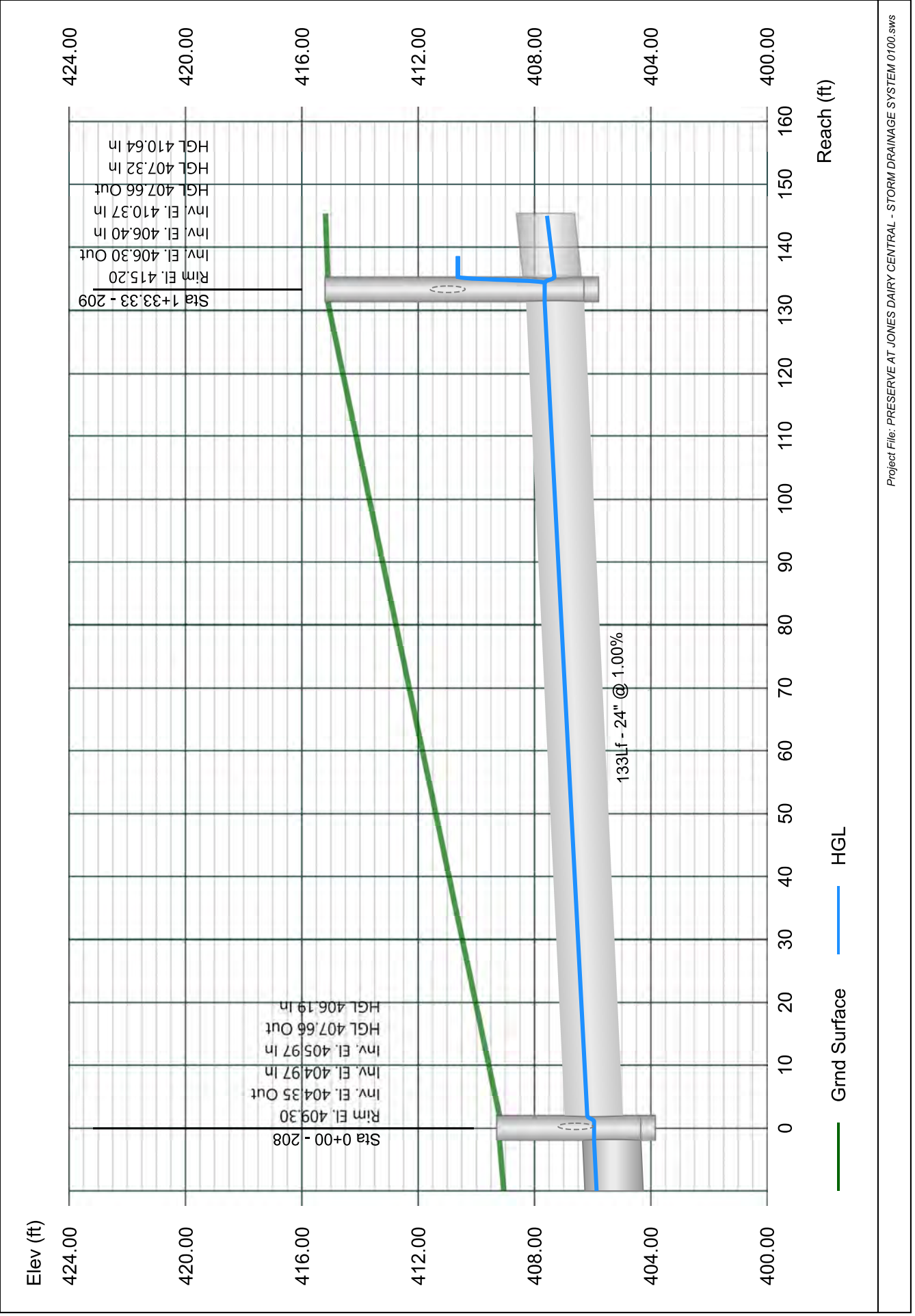

Line 111 - 211 TO 210

Stormwater Studio 2024 v 3.0.0.33

Project Name: Enter Project Name...

01-19-2024

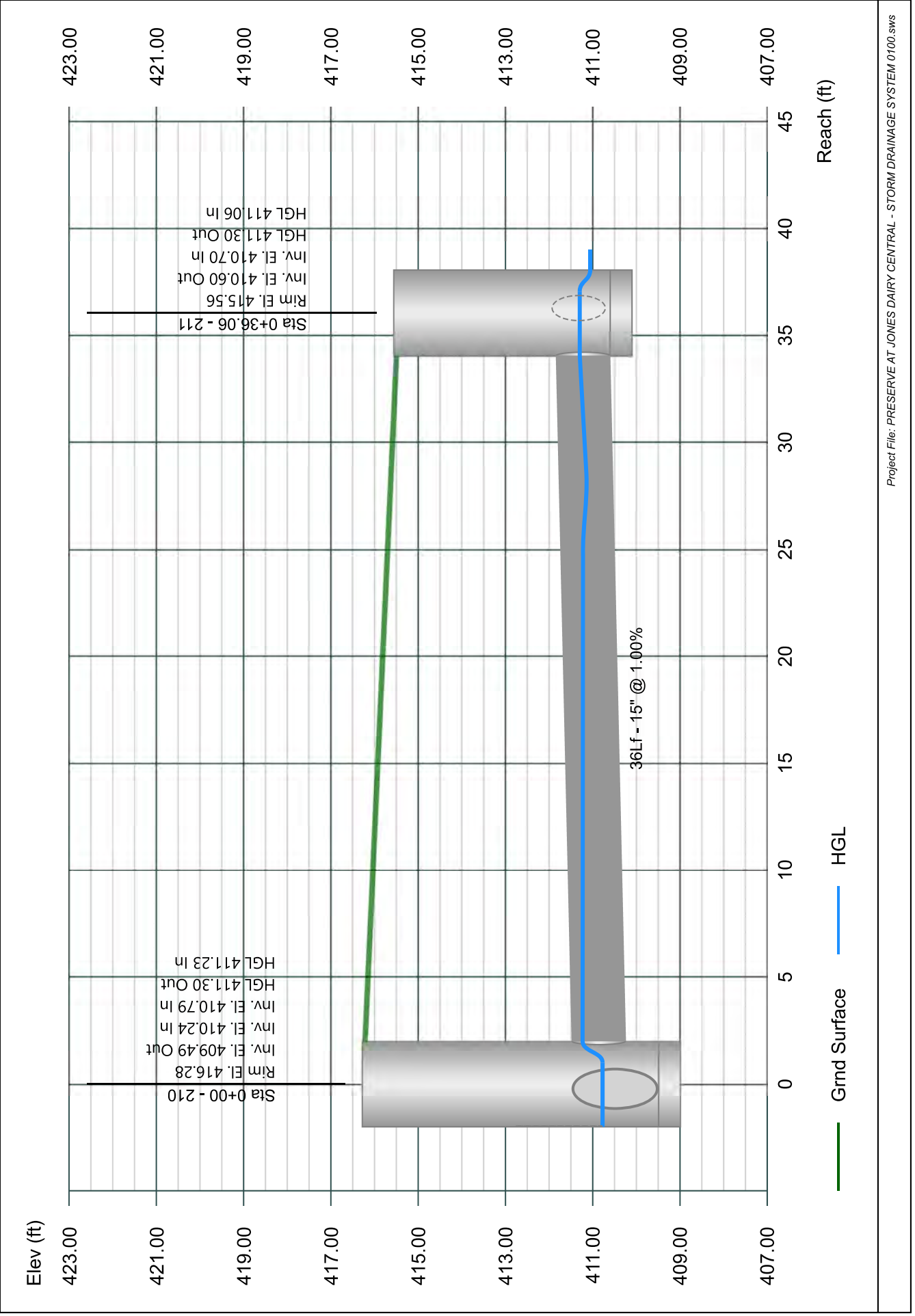

Line 112 - 212 TO 211

Stormwater Studio 2024 v 3.0.0.33

Project Name: Enter Project Name...

01-19-2024

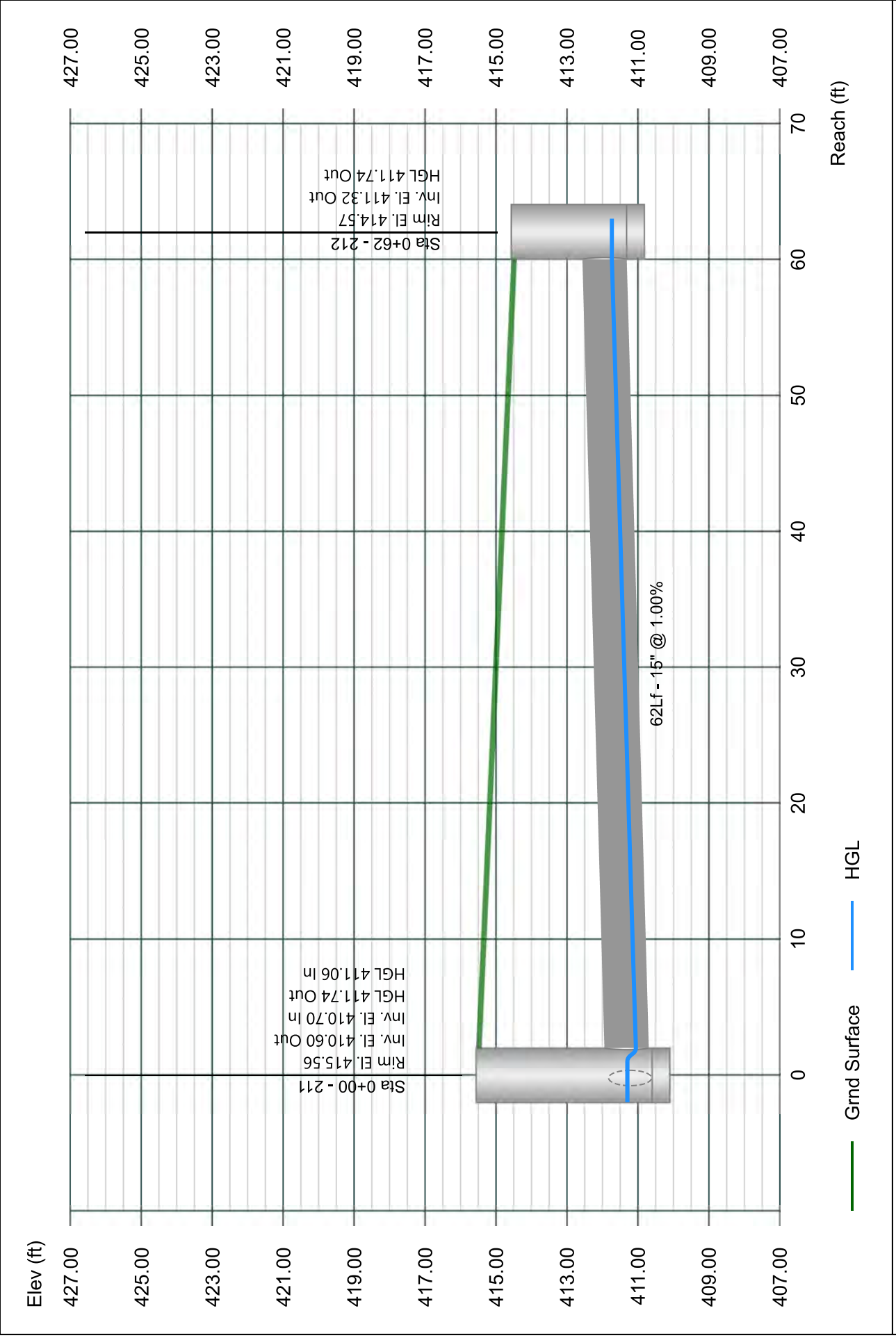

Line 113 - 213 TO 210

Stormwater Studio 2024 v 3.0.0.33

Project Name: Enter Project Name...

01-19-2024

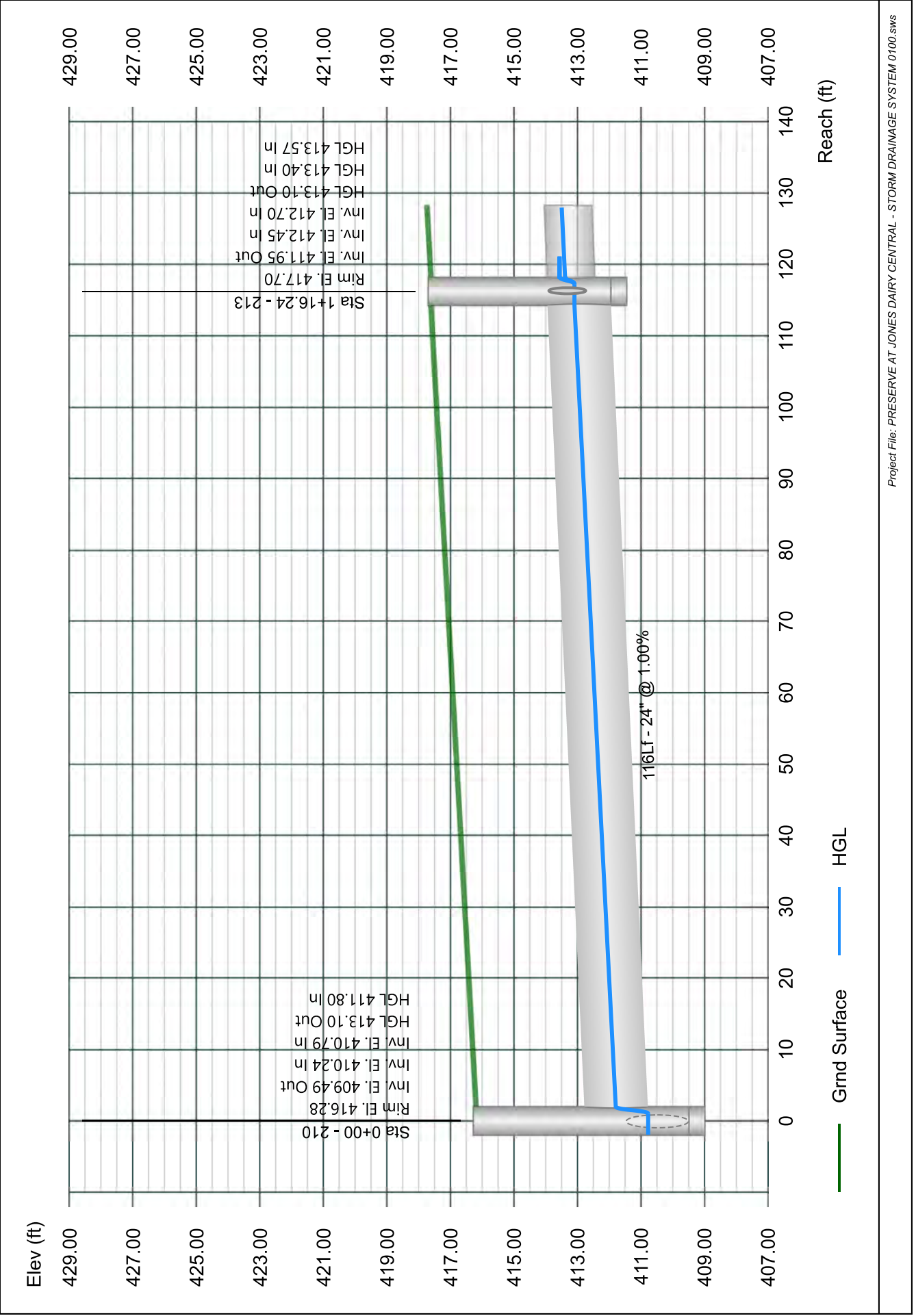

Line 114 - 213A TO 213

Stormwater Studio 2024 v 3.0.0.33

Project Name: Enter Project Name...

01-19-2024

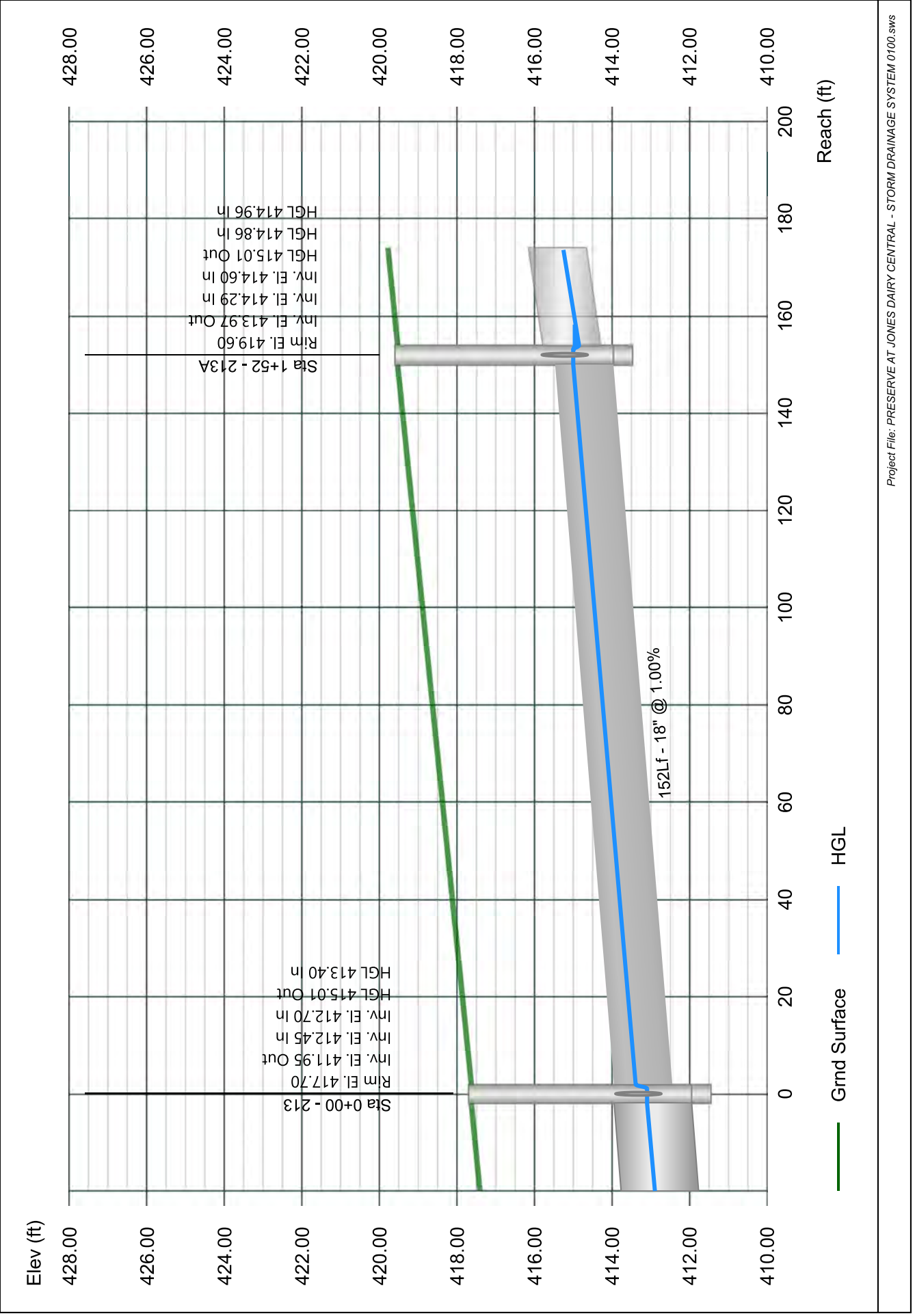

Line 115 - 214 TO 213A

Stormwater Studio 2024 v 3.0.0.33

Project Name: Enter Project Name...

01-19-2024

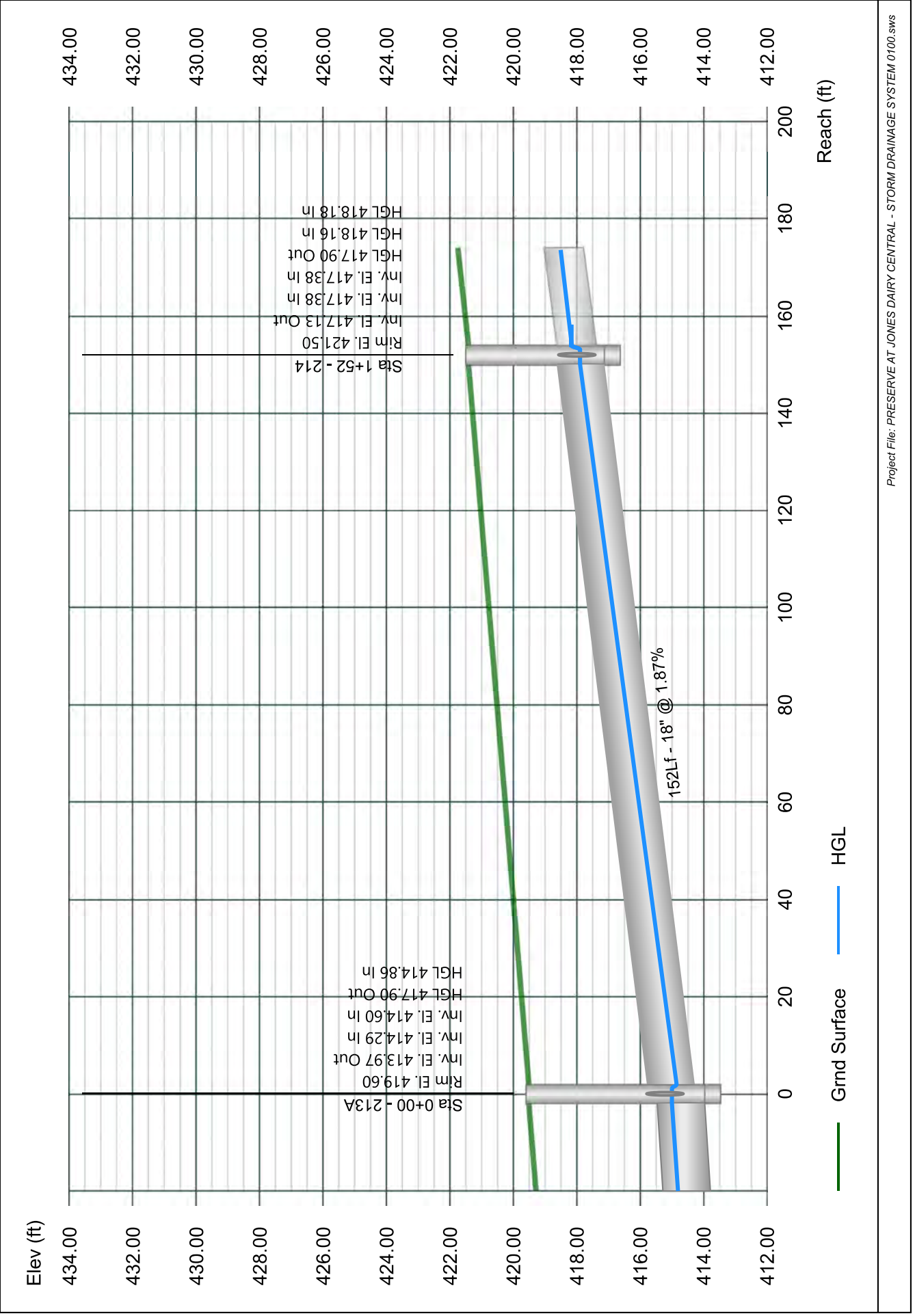

Line 116 - 215 TO 214

Stormwater Studio 2024 v 3.0.0.33

Project Name: Enter Project Name...

01-19-2024

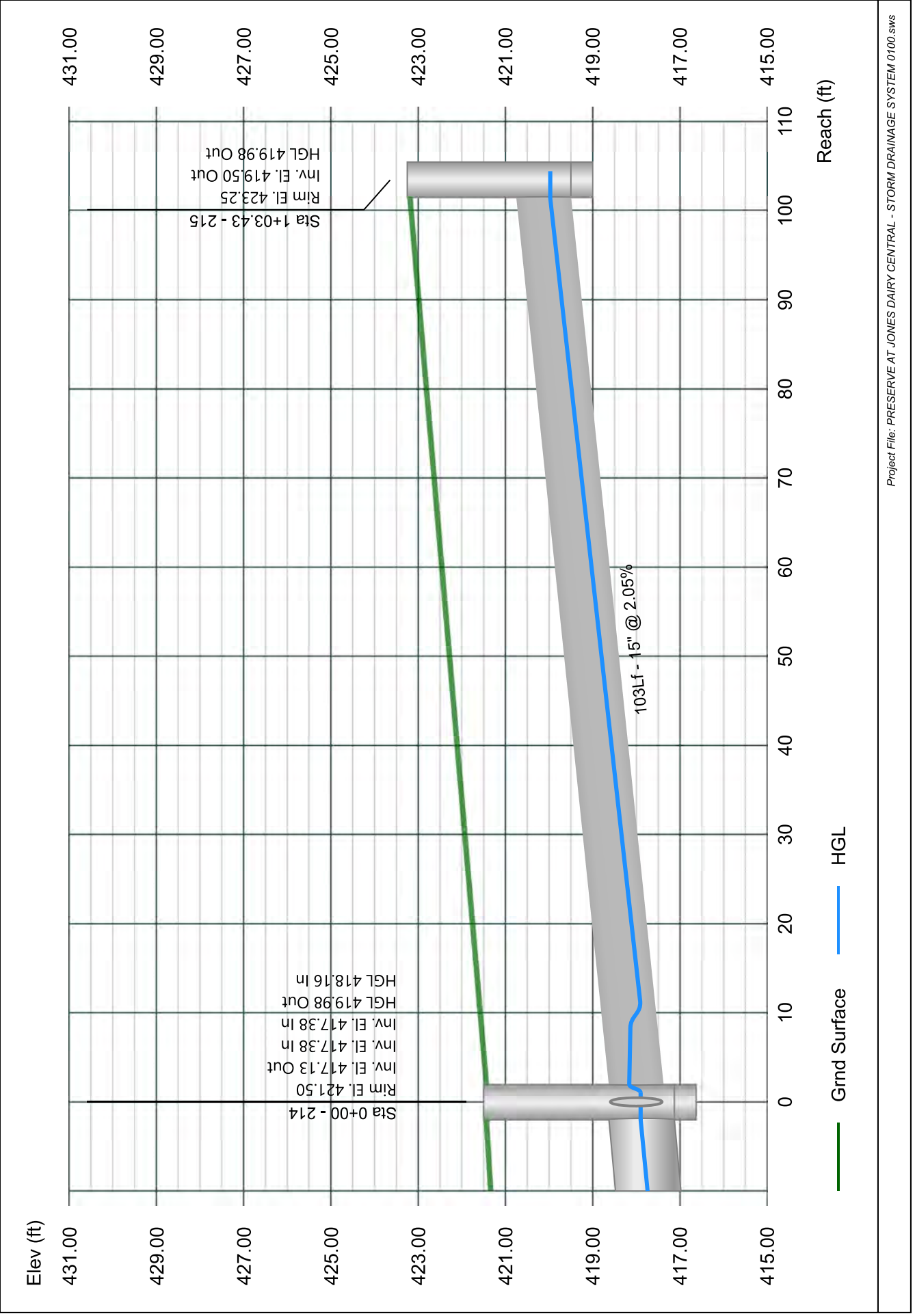

Line 117 - 216 TO 214

Stormwater Studio 2024 v 3.0.0.33

Project Name: Enter Project Name...

01-19-2024

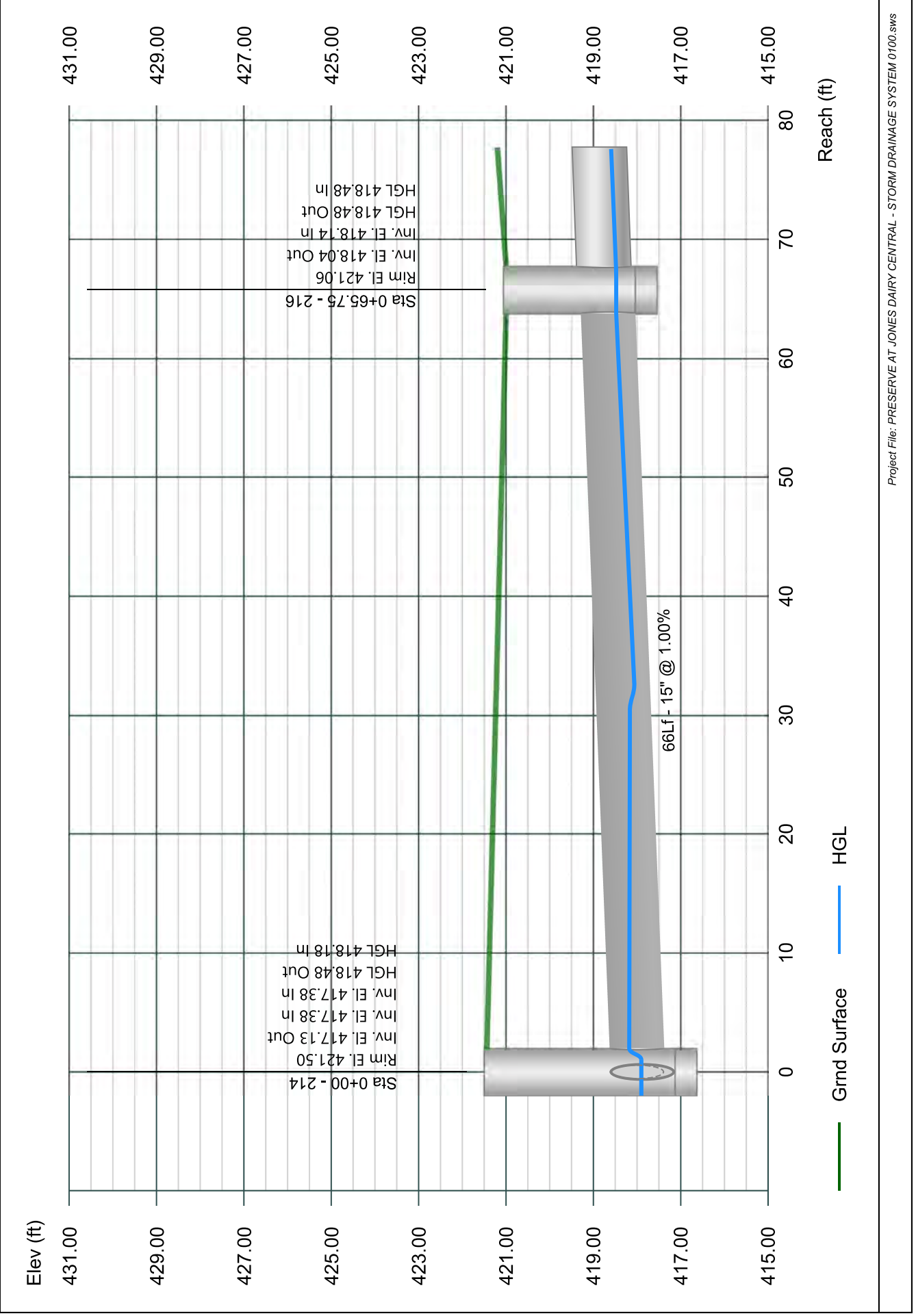

Line 118 - 217 TO 216

Stormwater Studio 2024 v 3.0.0.33

Project Name: Enter Project Name...

01-19-2024

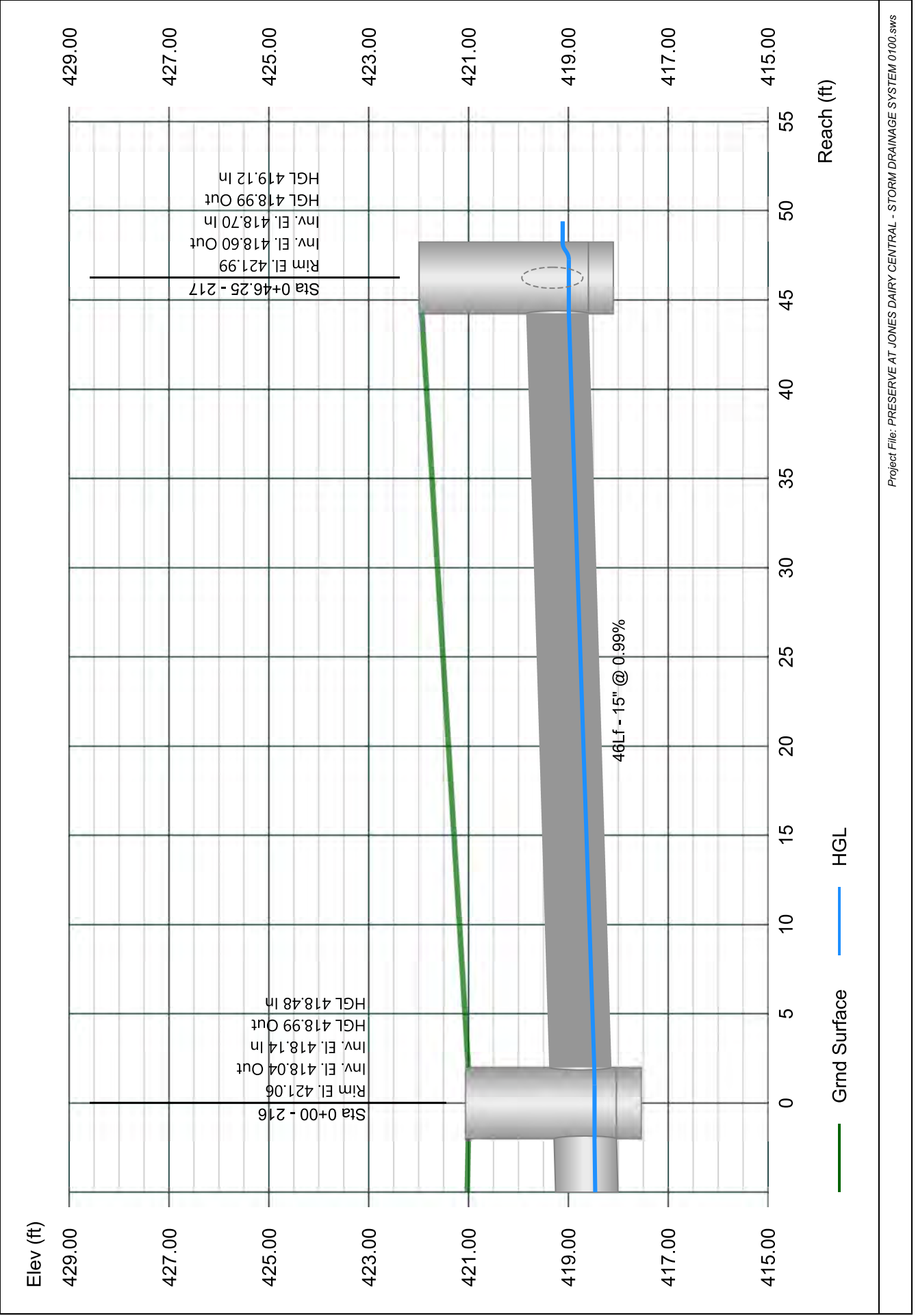

Line 119 - 218 TO 217

Stormwater Studio 2024 v 3.0.0.33

Project Name: Enter Project Name...

01-19-2024

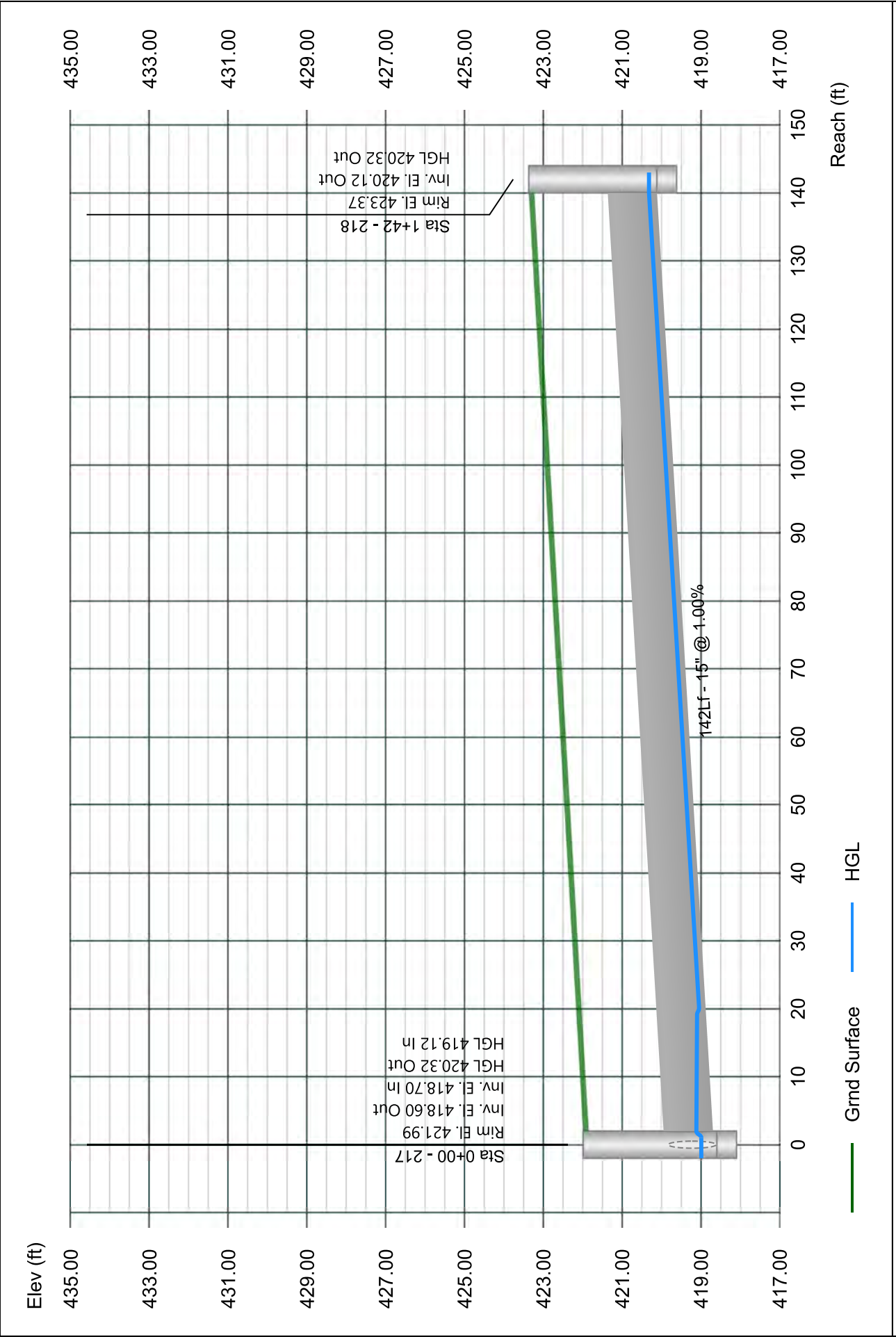

Line 120 - 219 TO 213

Stormwater Studio 2024 v 3.0.0.33

Project Name: Enter Project Name...

01-19-2024

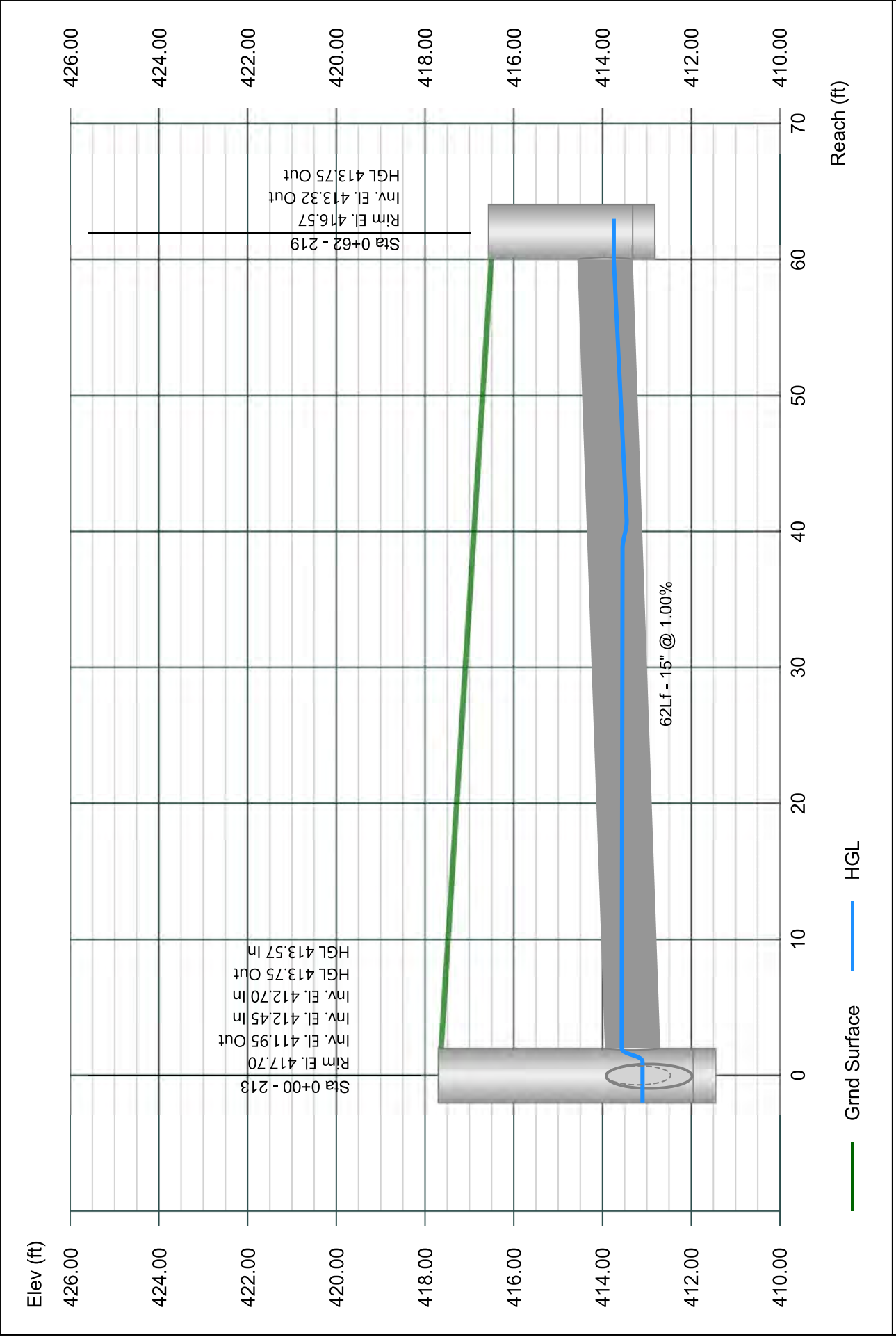

Line 121 - 220 TO 209

Stormwater Studio 2024 v 3.0.0.33

Project Name: Enter Project Name...

01-19-2024

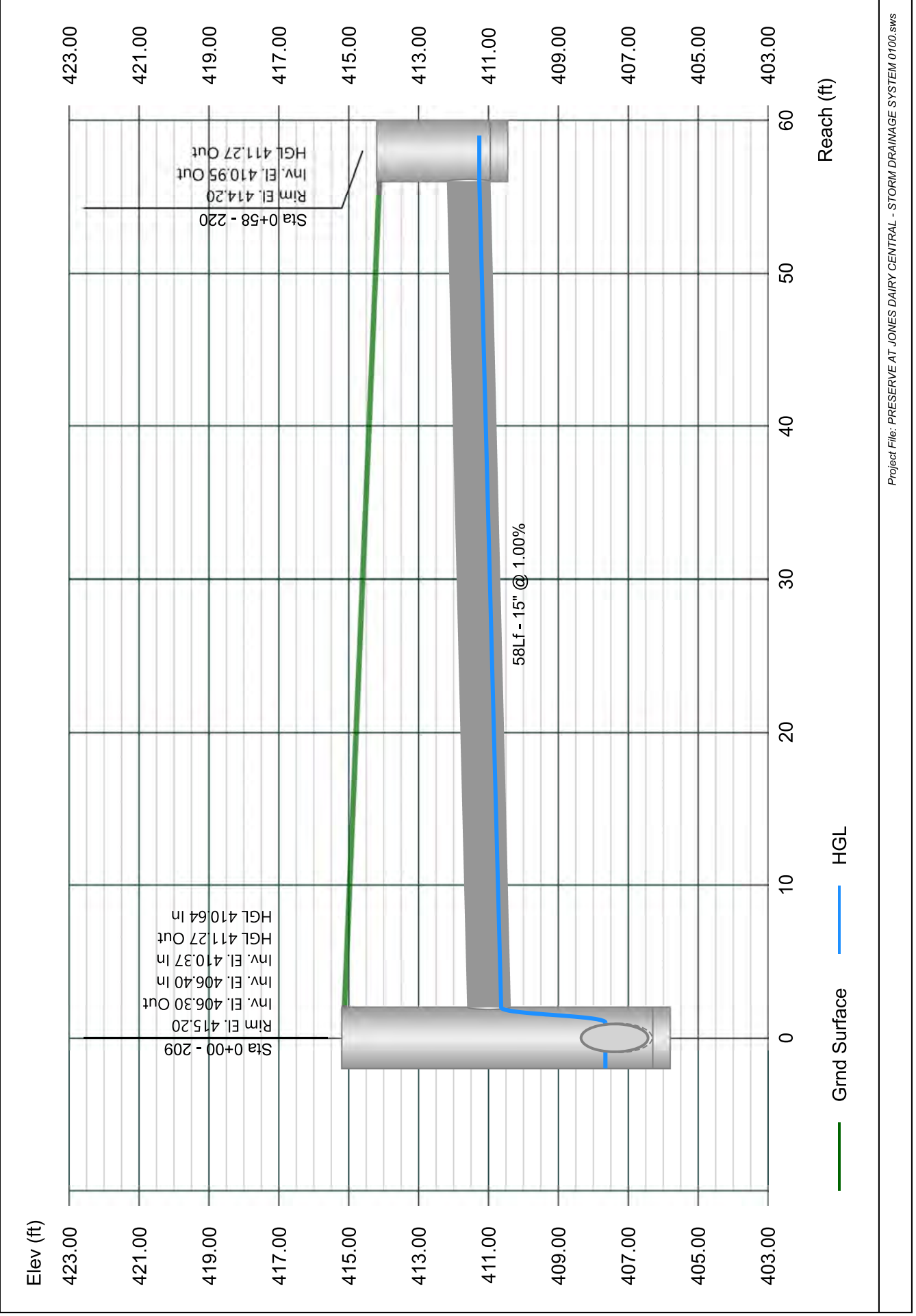

Line 122 - 221 TO 208

Stormwater Studio 2024 v 3.0.0.33

Project Name: Enter Project Name...

01-19-2024

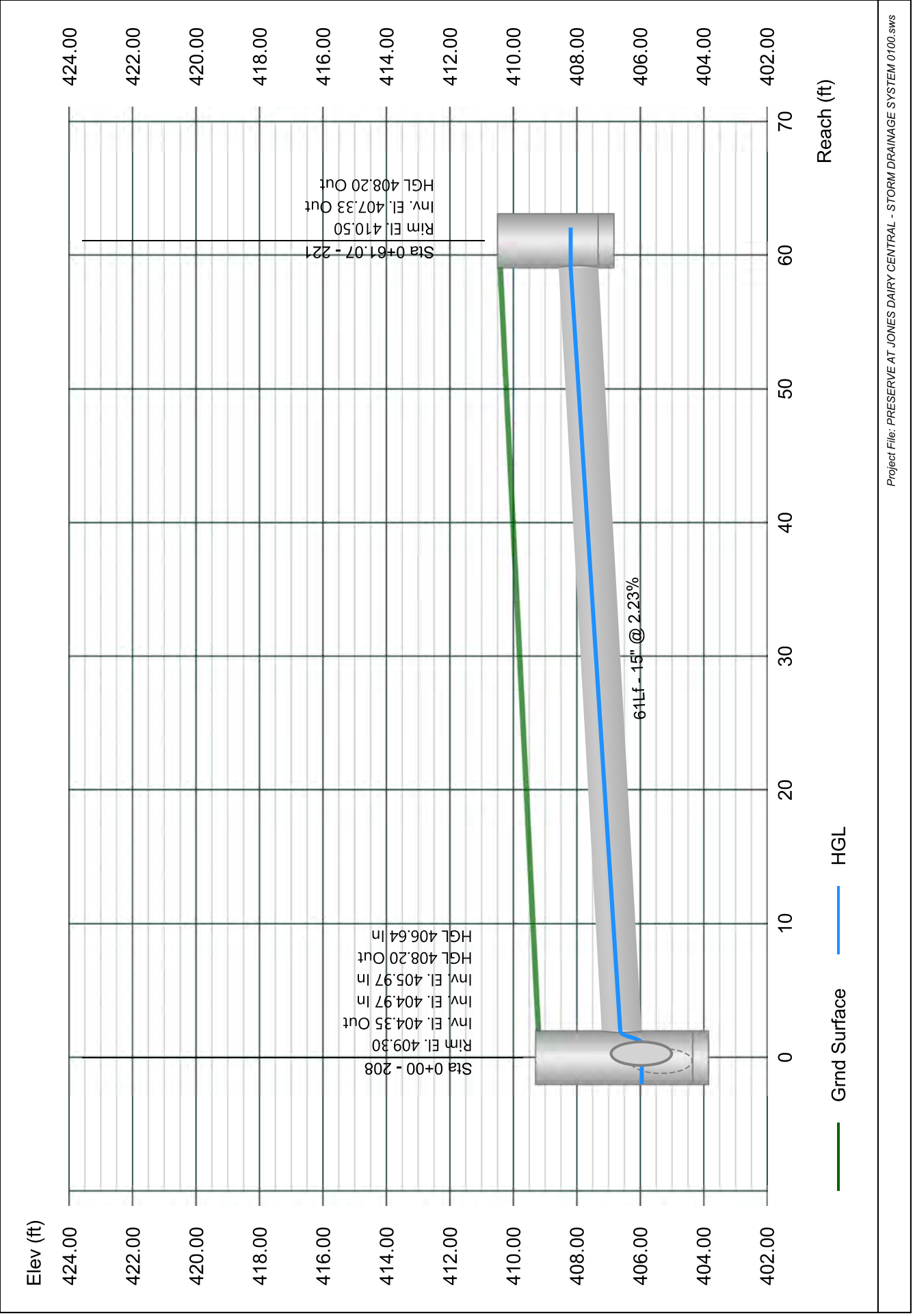

Line 123 - 222 TO 190

Stormwater Studio 2024 v 3.0.0.33

Project Name: Enter Project Name...

01-19-2024

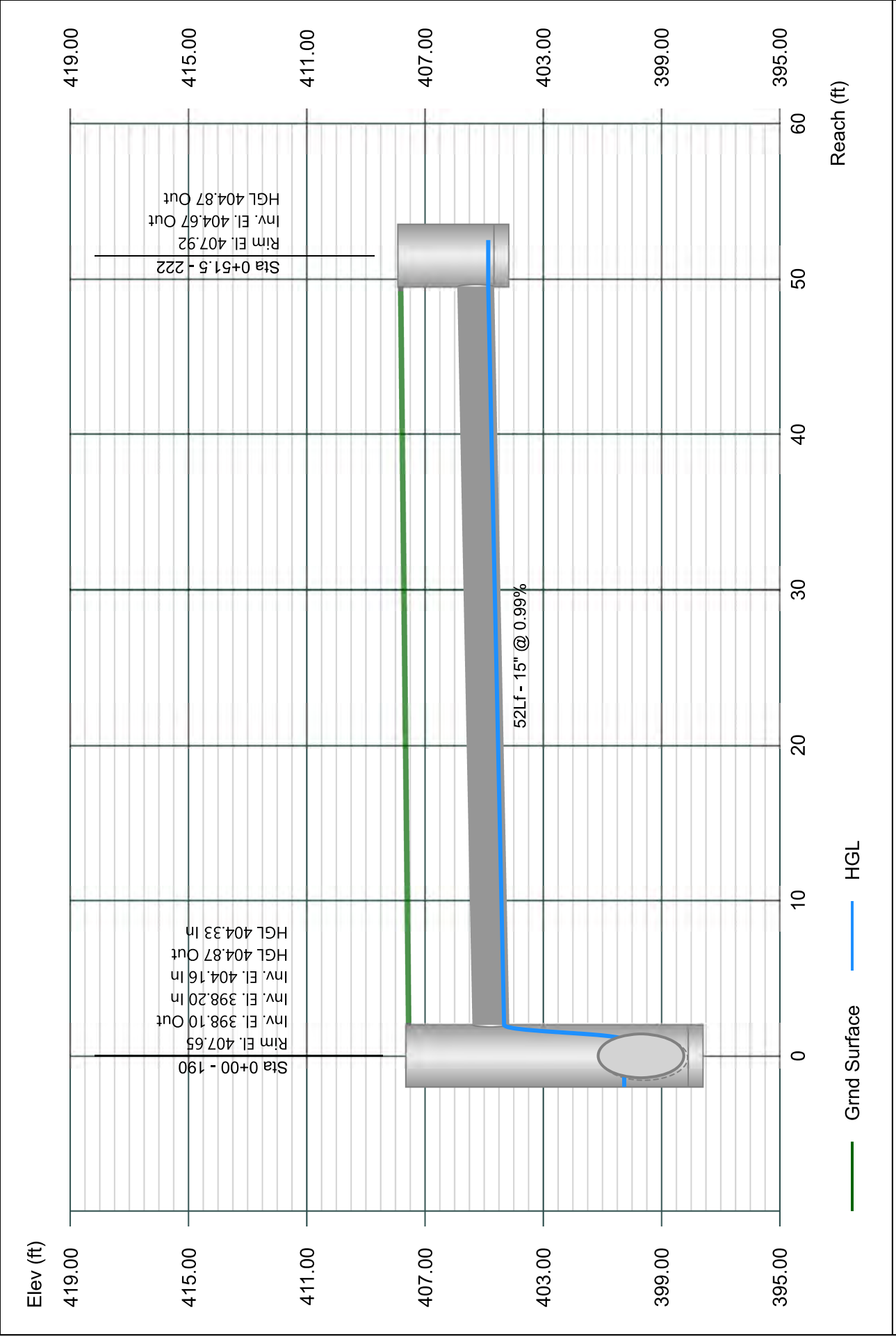

Line 124 - 223 TO 189

Stormwater Studio 2024 v 3.0.0.33

Project Name: Enter Project Name...

01-19-2024

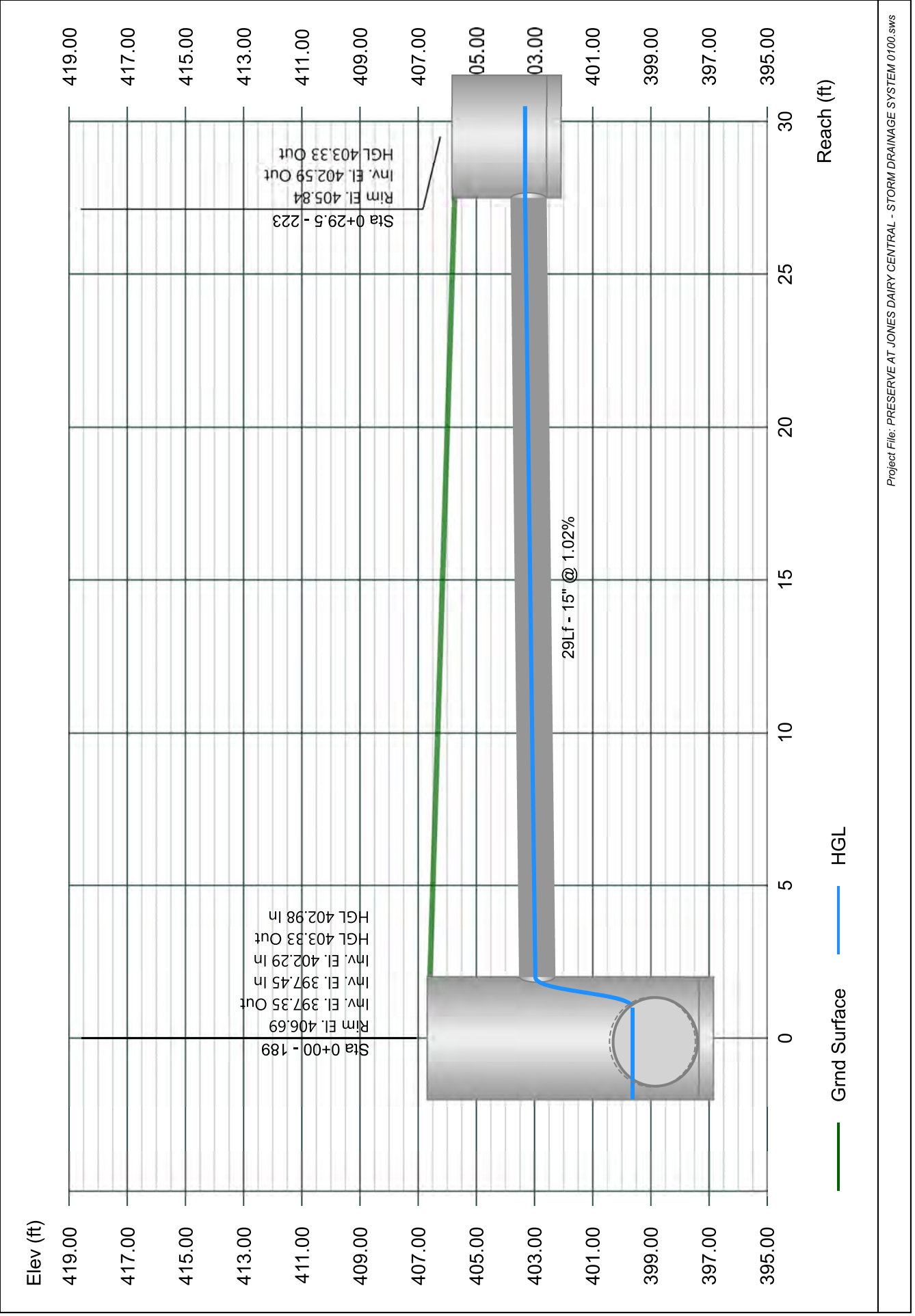

Line 125 - 314 TO 112

Stormwater Studio 2024 v 3.0.0.33

Project Name: Enter Project Name...

01-19-2024

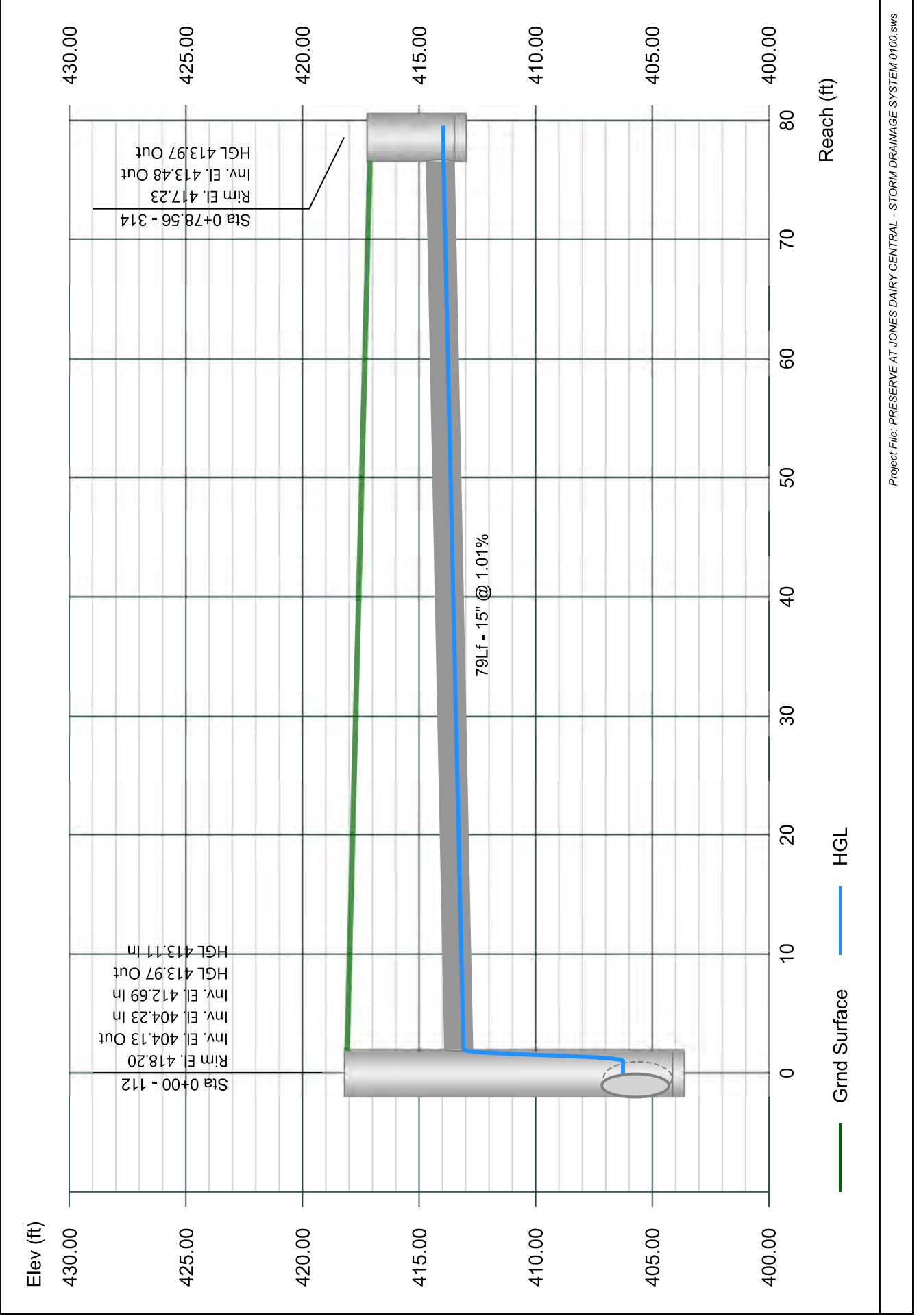

Line 1 - 301 TO 300

Stormwater Studio 2023 v 3.0.0.31

Project Name: Enter Project Name...

05-03-2023

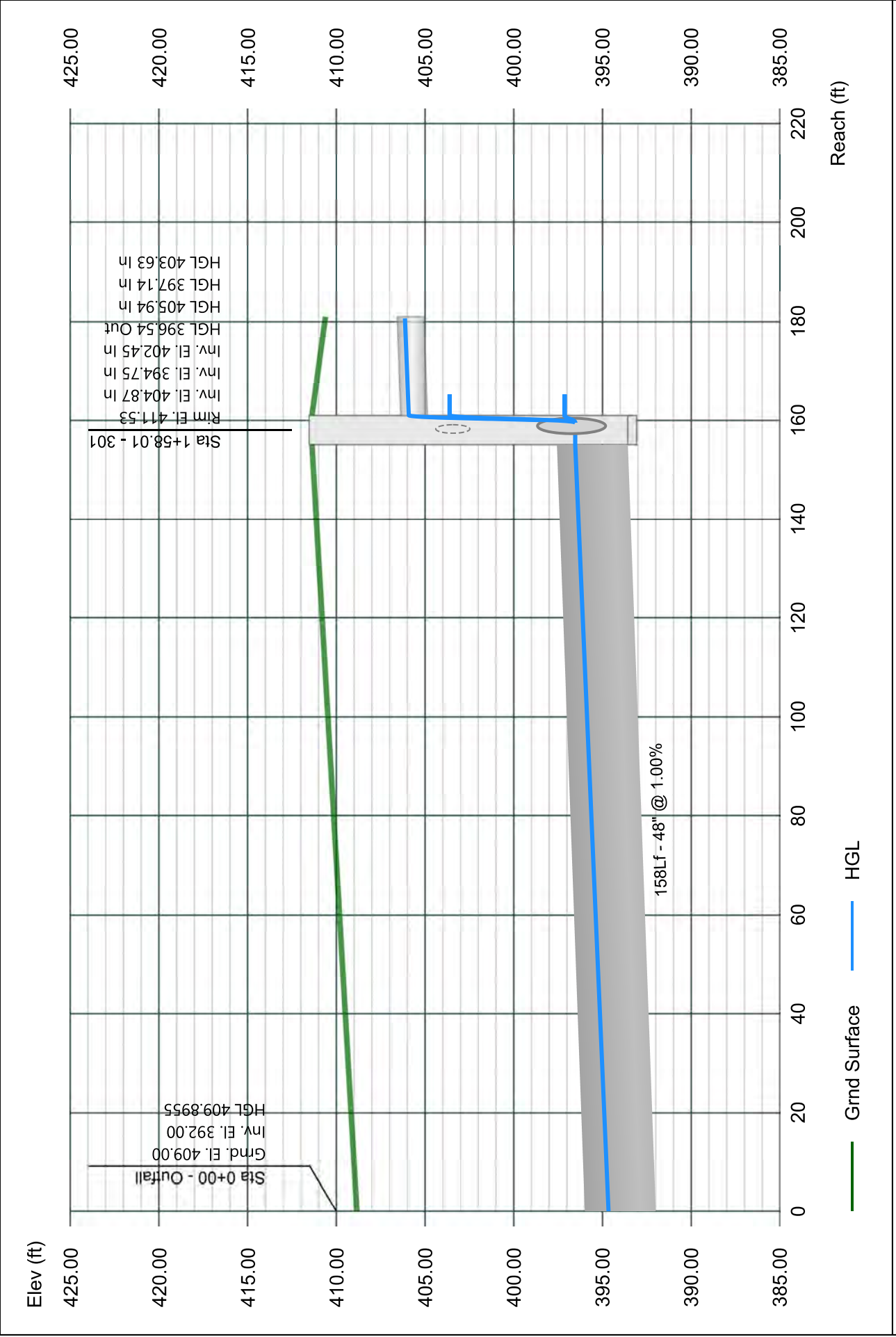

Line 2 - 318 TO 301

Stormwater Studio 2023 v 3.0.0.31

Project Name: Enter Project Name...

05-03-2023

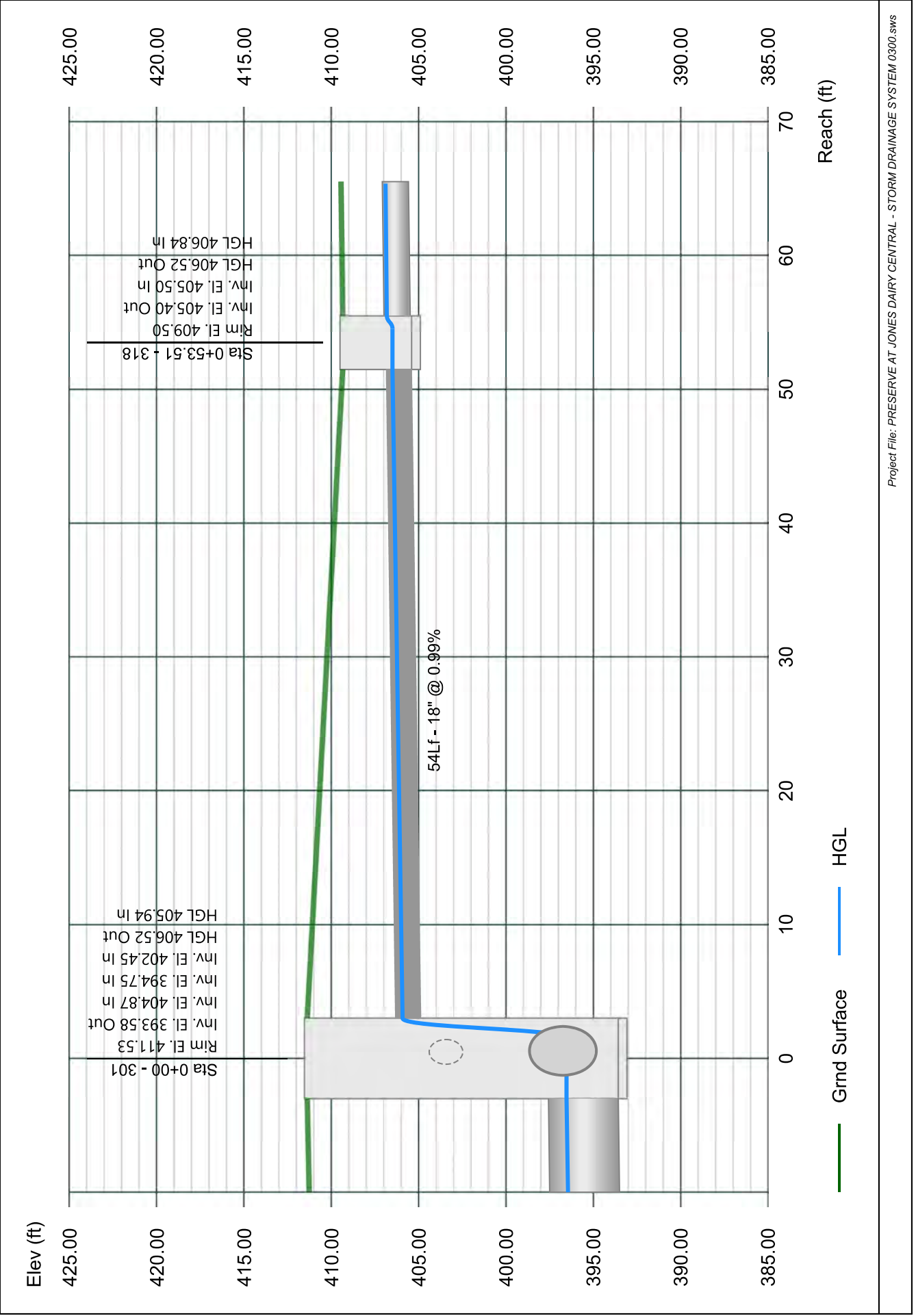

Line 3 - 319 TO 318

Stormwater Studio 2023 v 3.0.0.31

Project Name: Enter Project Name...

05-03-2023

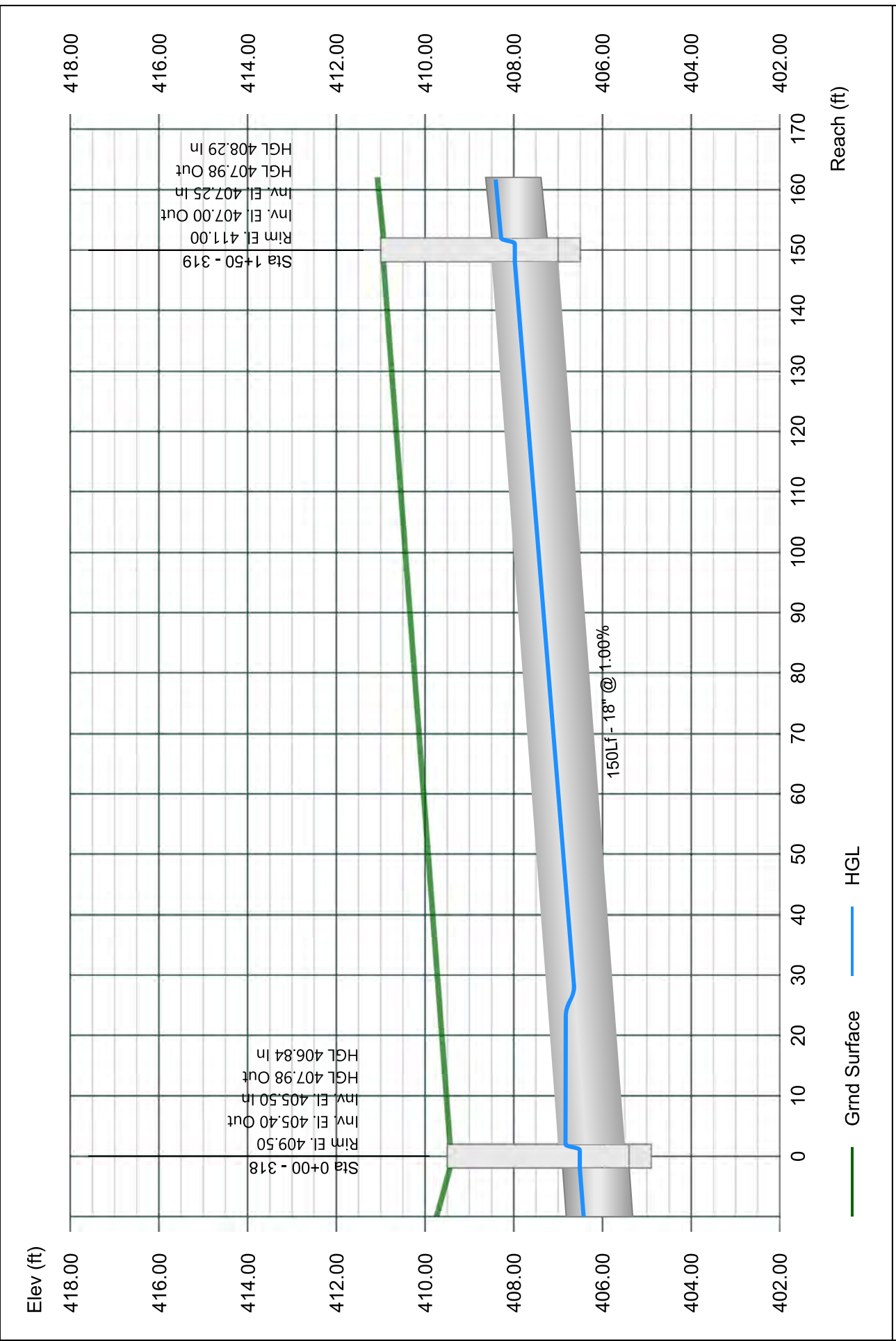

Line 4 - 320 TO 319

Stormwater Studio 2023 v 3.0.0.31

Project Name: Enter Project Name...

05-03-2023

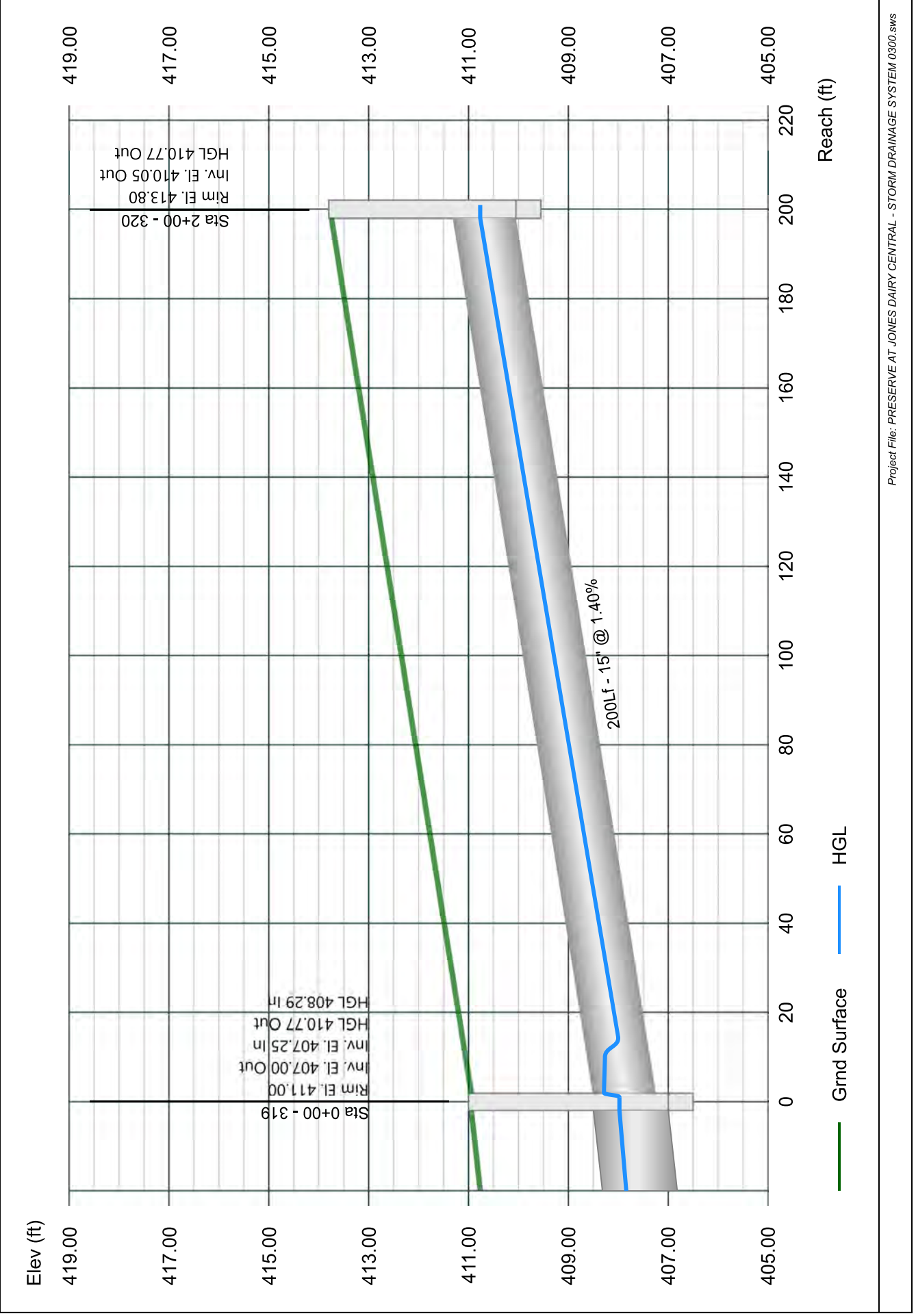

Line 5 - 302 TO 301

Stormwater Studio 2023 v 3.0.0.31

Project Name: Enter Project Name...

05-03-2023

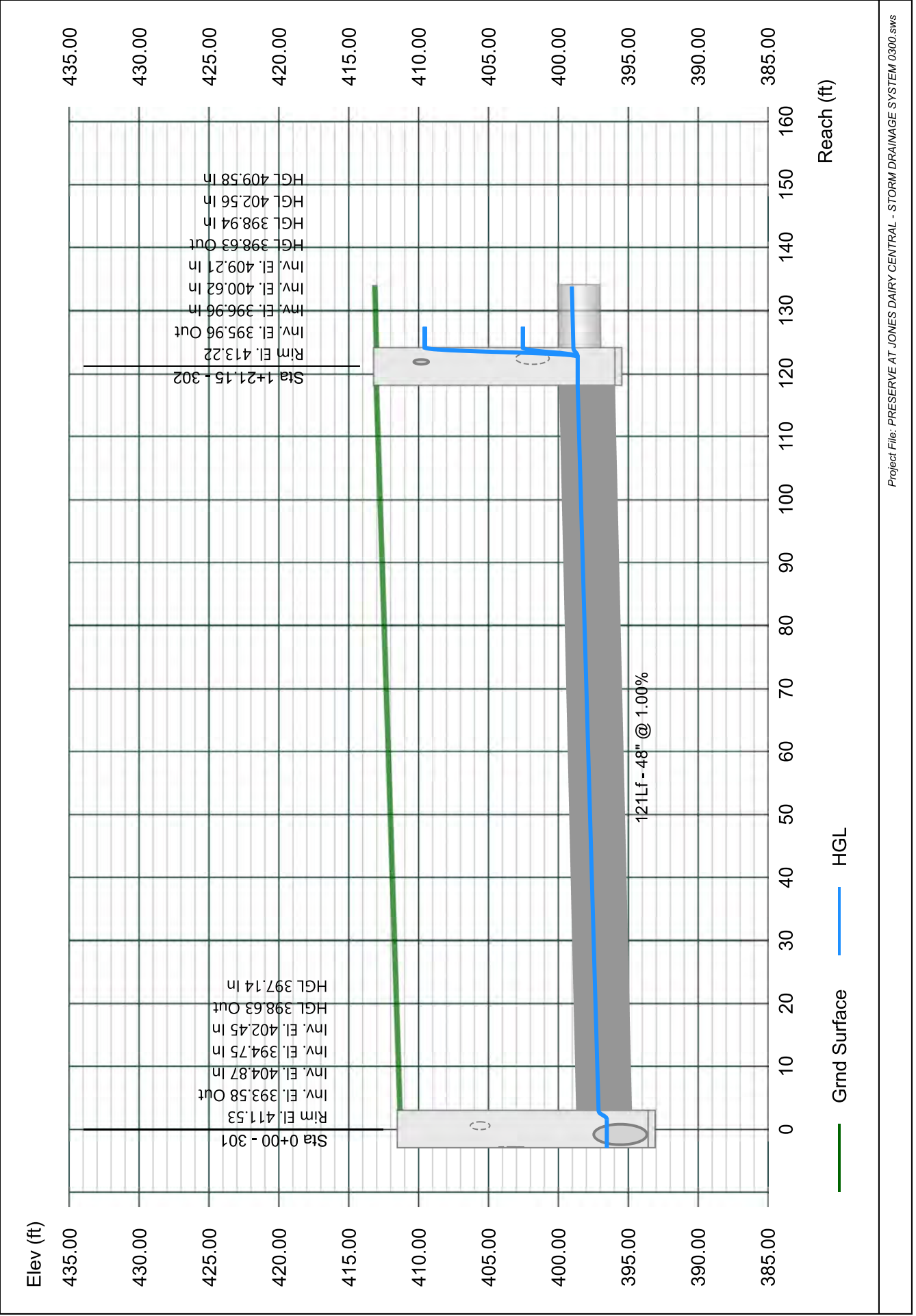

Line 6 - 303 TO 302

Stormwater Studio 2023 v 3.0.0.31

Project Name: Enter Project Name...

05-03-2023

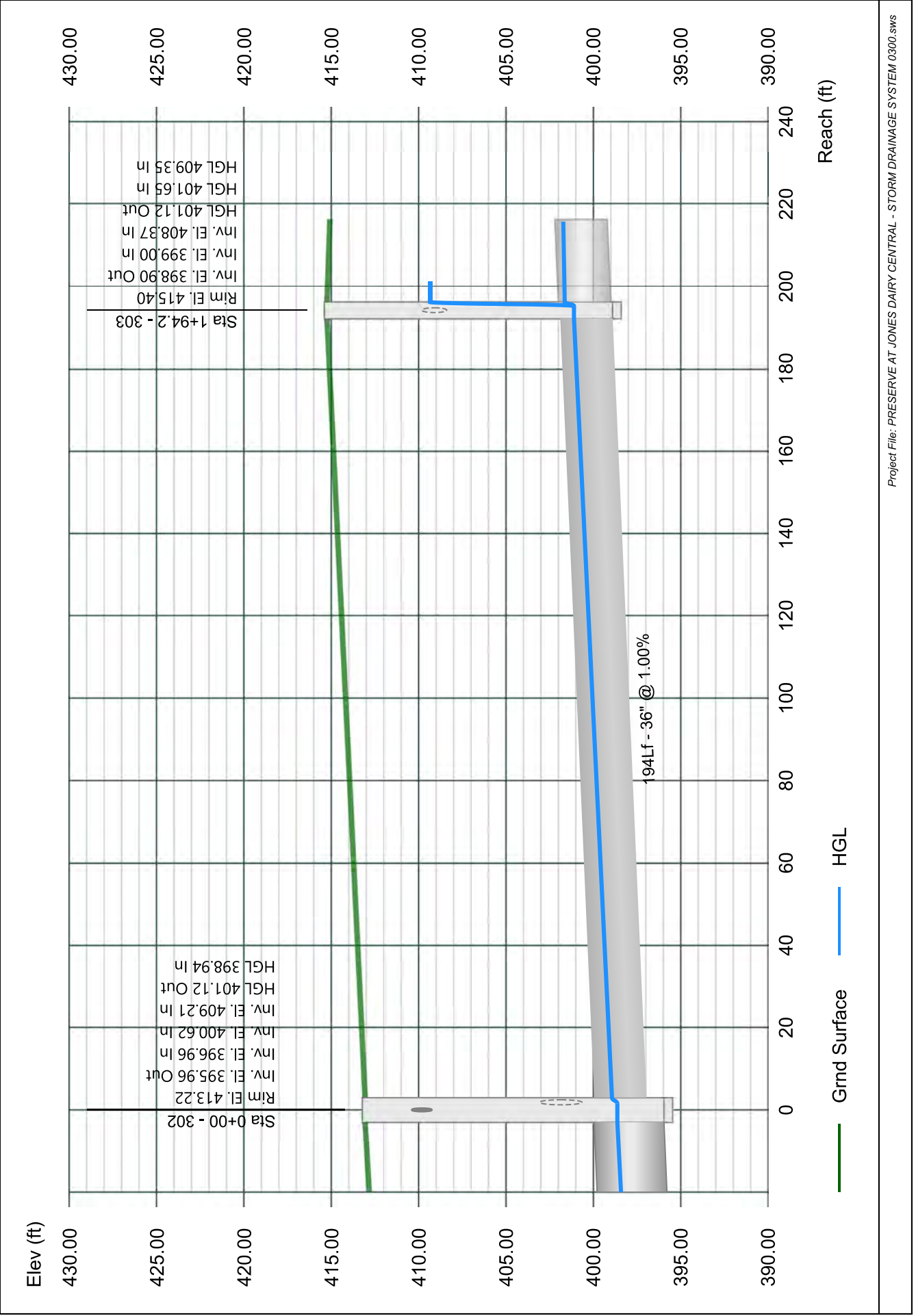

Line 7 - 304 TO 303

Stormwater Studio 2023 v 3.0.0.31

Project Name: Enter Project Name...

05-03-2023

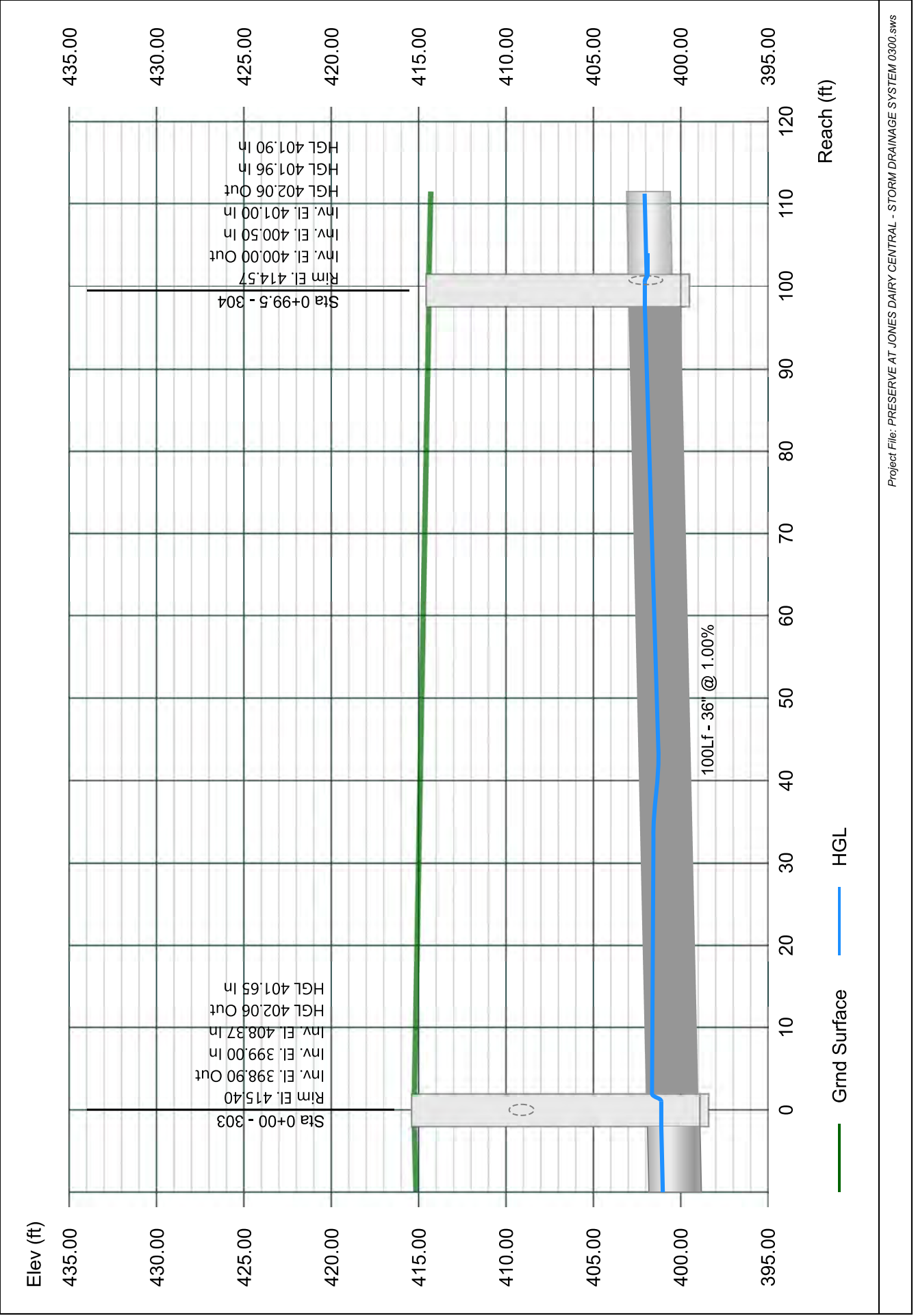

Line 8 - 305 TO 304

Stormwater Studio 2023 v 3.0.0.31

Project Name: Enter Project Name...

05-03-2023

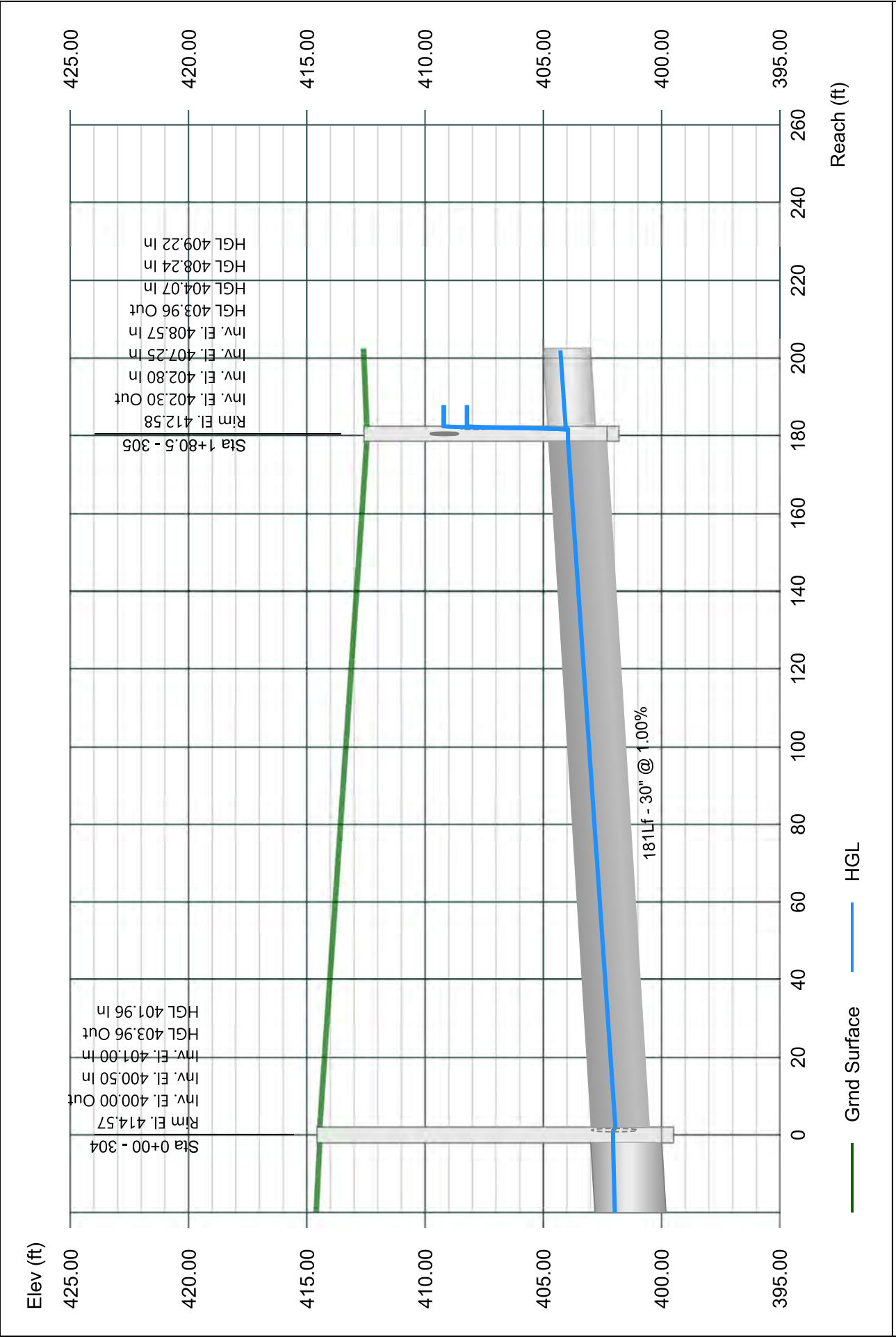

Line 9 - 306 TO 305

Stormwater Studio 2023 v 3.0.0.31

Project Name: Enter Project Name...

05-03-2023

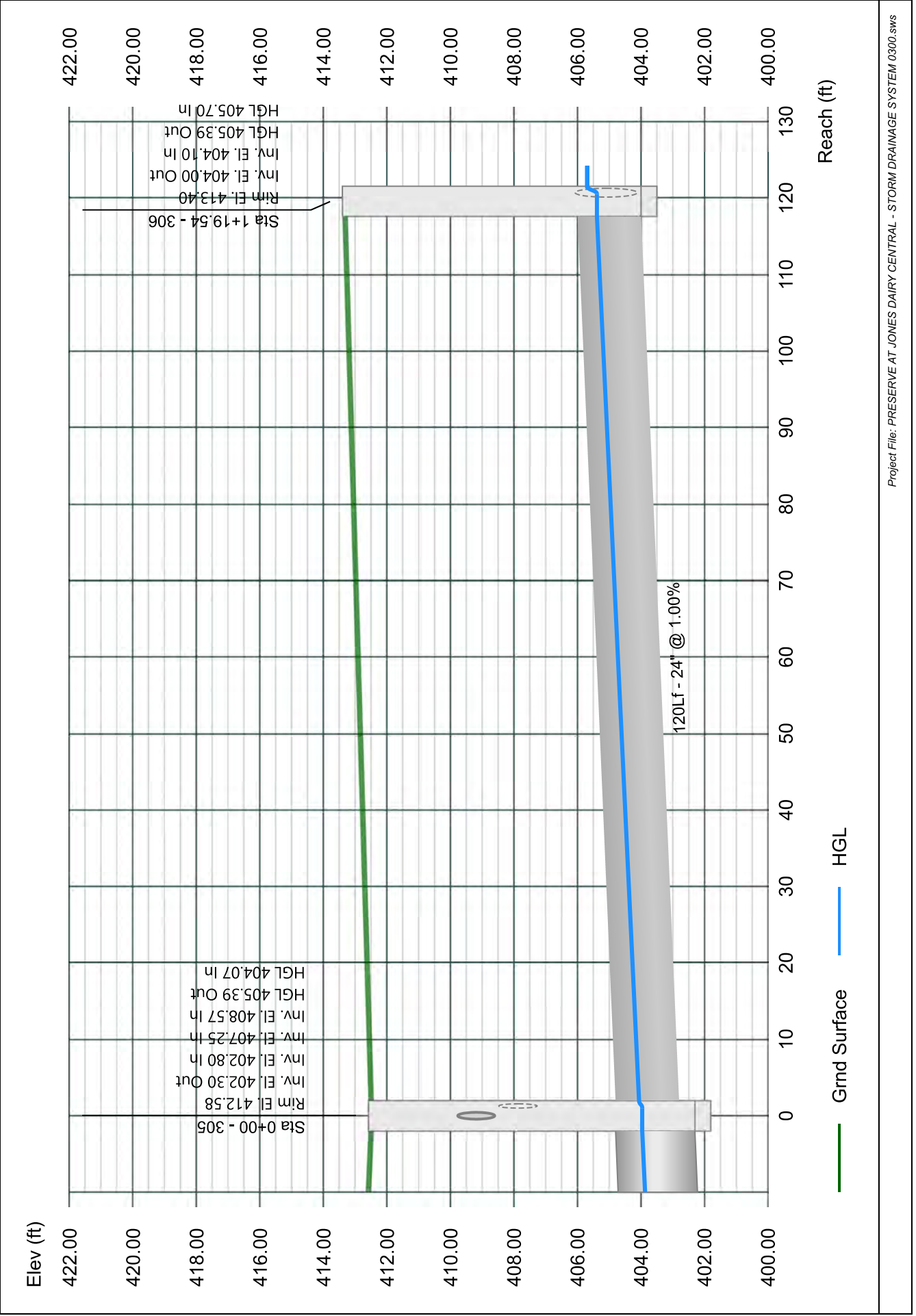

Line 10 - 307 TO 306

Stormwater Studio 2023 v 3.0.0.31

Project Name: Enter Project Name...

05-03-2023

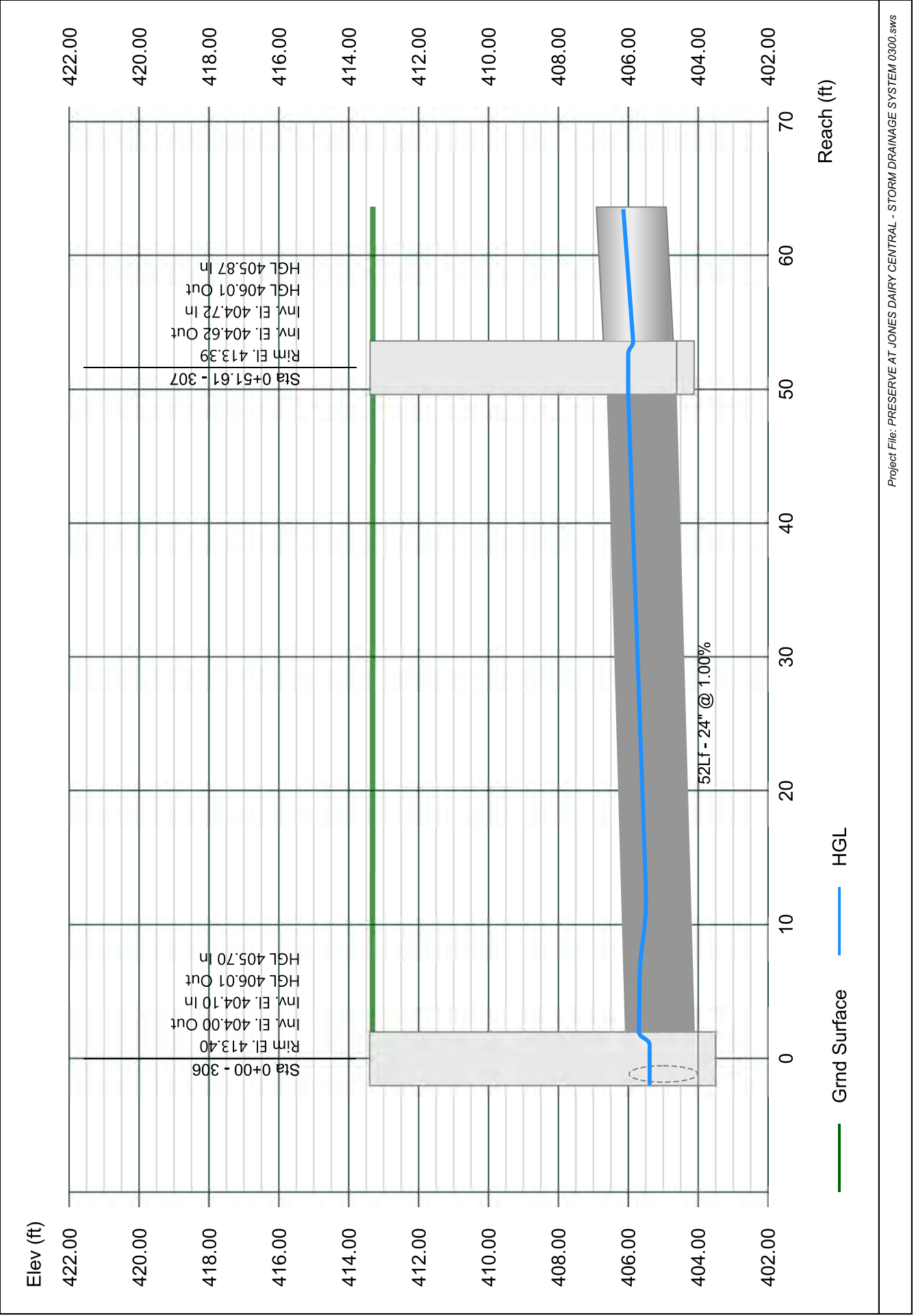

Line 11 - 308 TO 307

Stormwater Studio 2023 v 3.0.0.31

Project Name: Enter Project Name...

05-03-2023

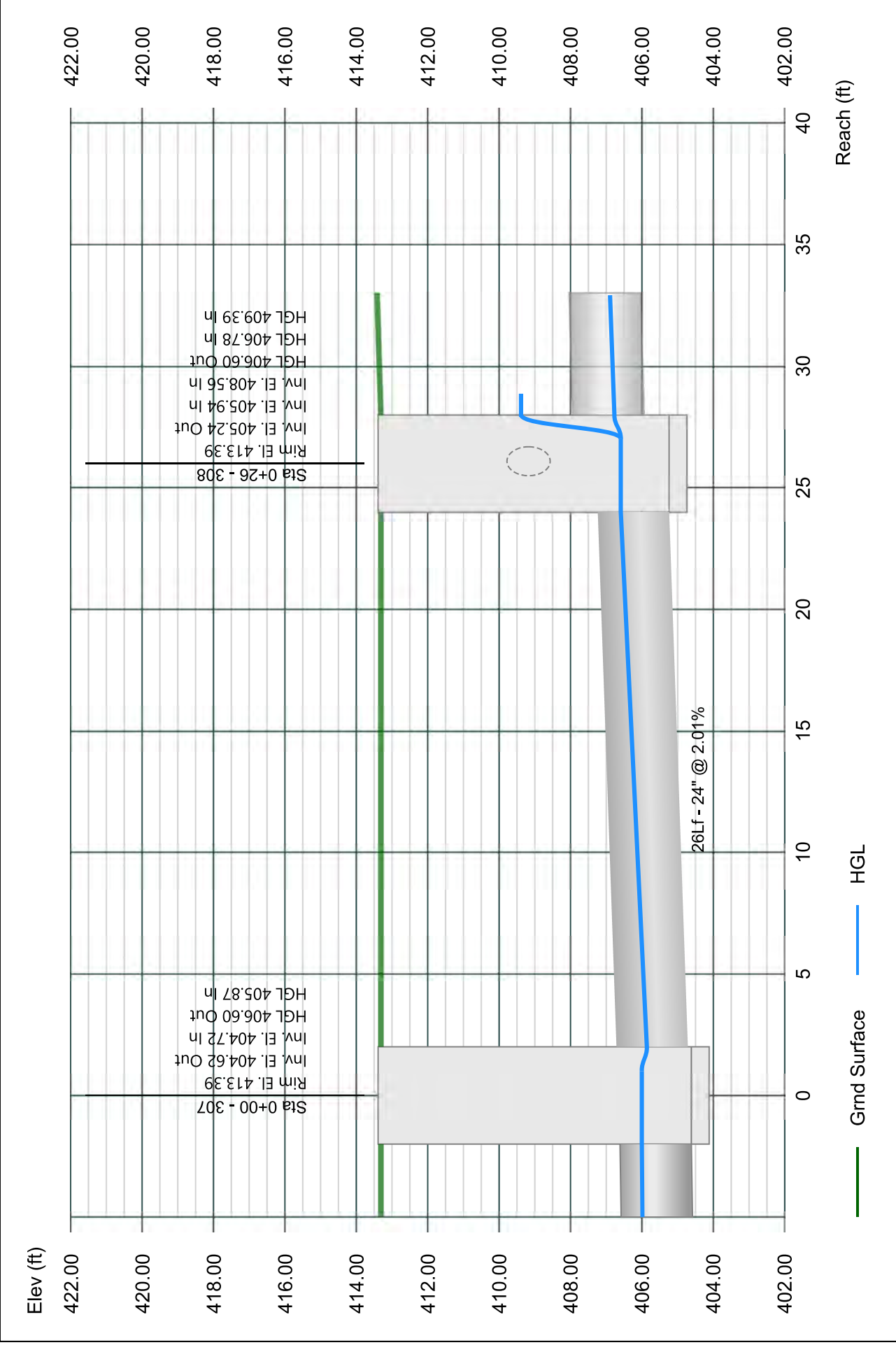

Line 12 - 309 TO 308

Stormwater Studio 2023 v 3.0.0.31

Project Name: Enter Project Name...

05-03-2023

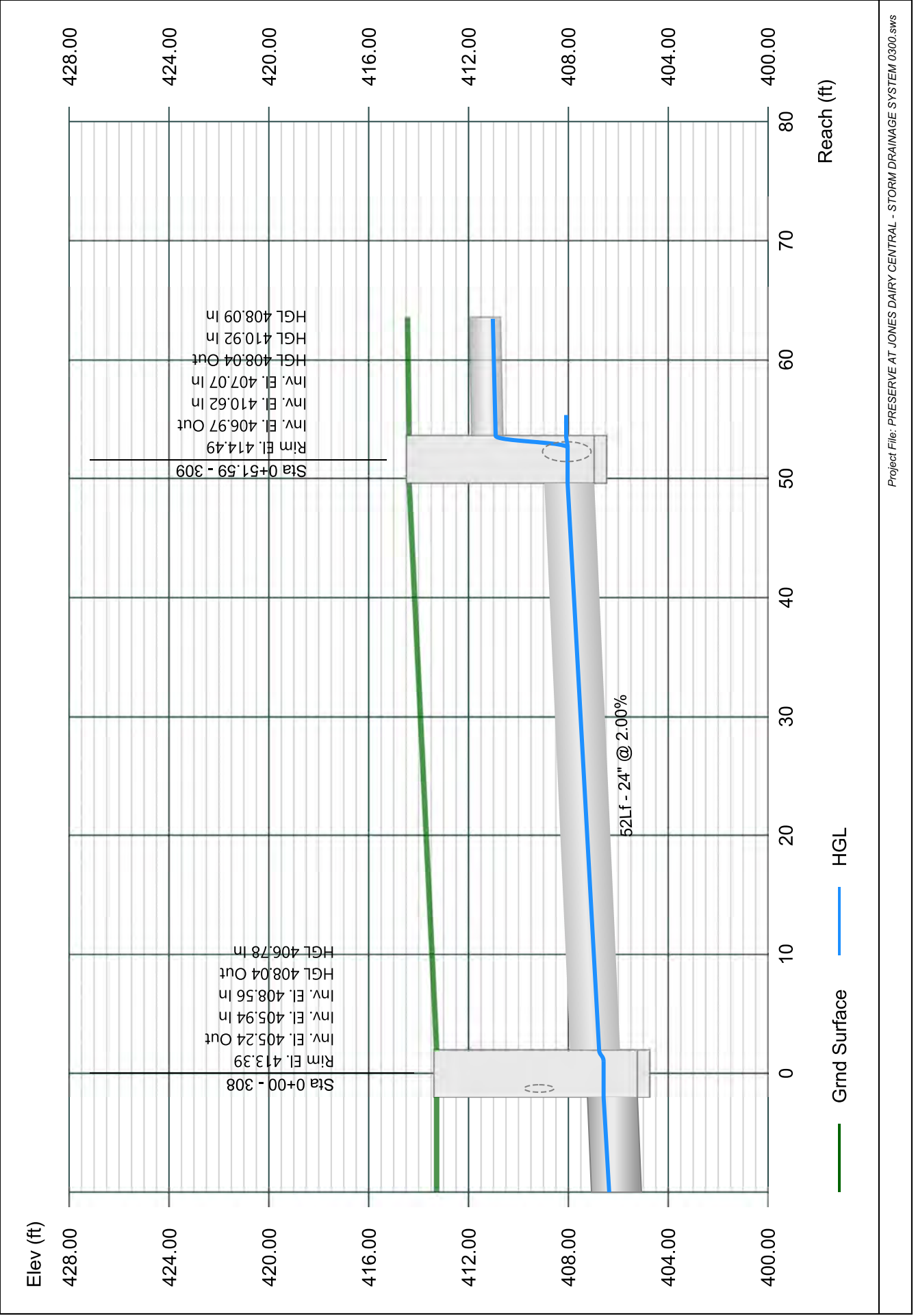

Line 13 - 363 TO 309

Stormwater Studio 2023 v 3.0.0.31

Project Name: Enter Project Name...

05-03-2023

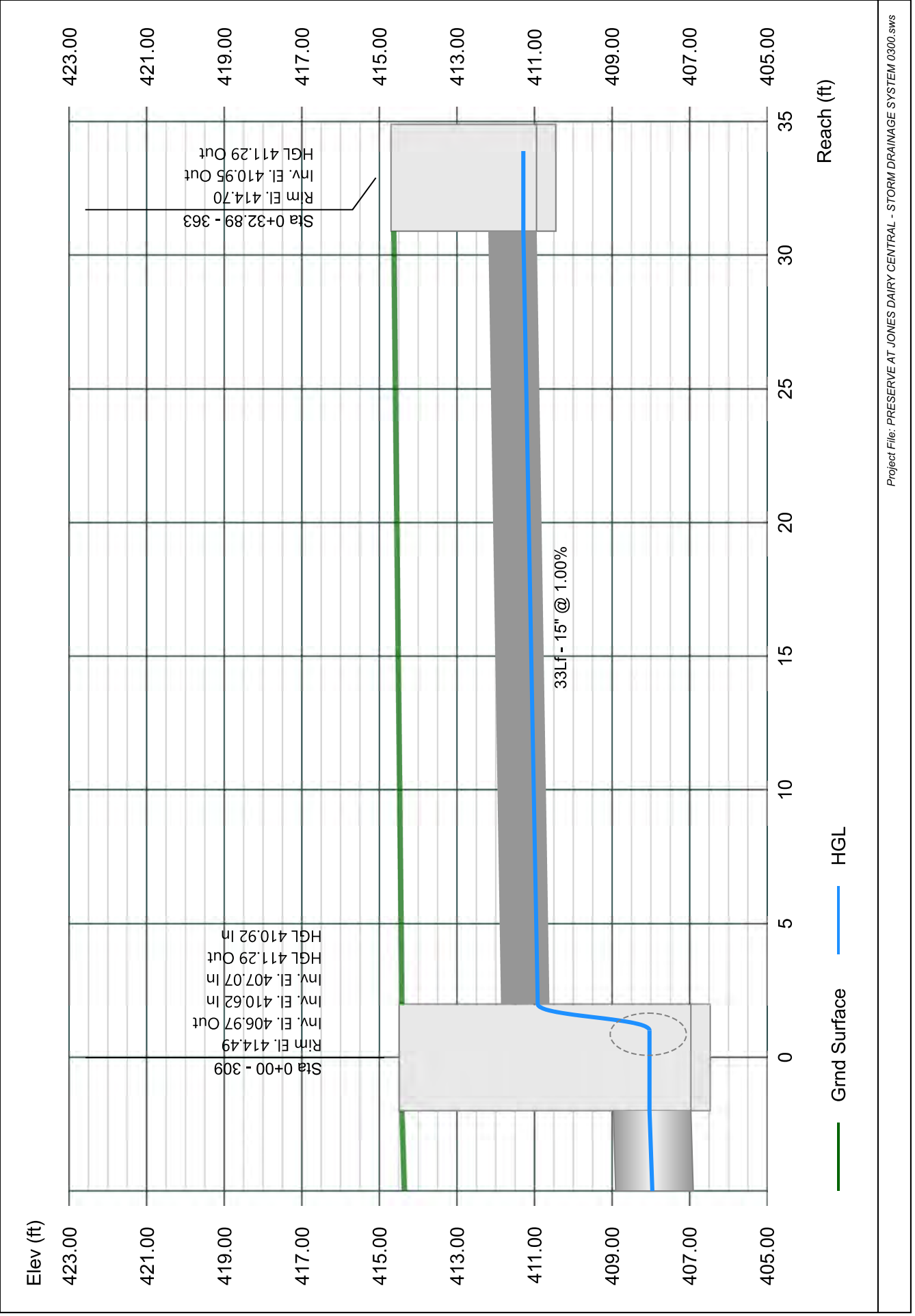

Line 14 - 310 TO 309

Stormwater Studio 2023 v 3.0.0.31

Project Name: Enter Project Name...

05-03-2023

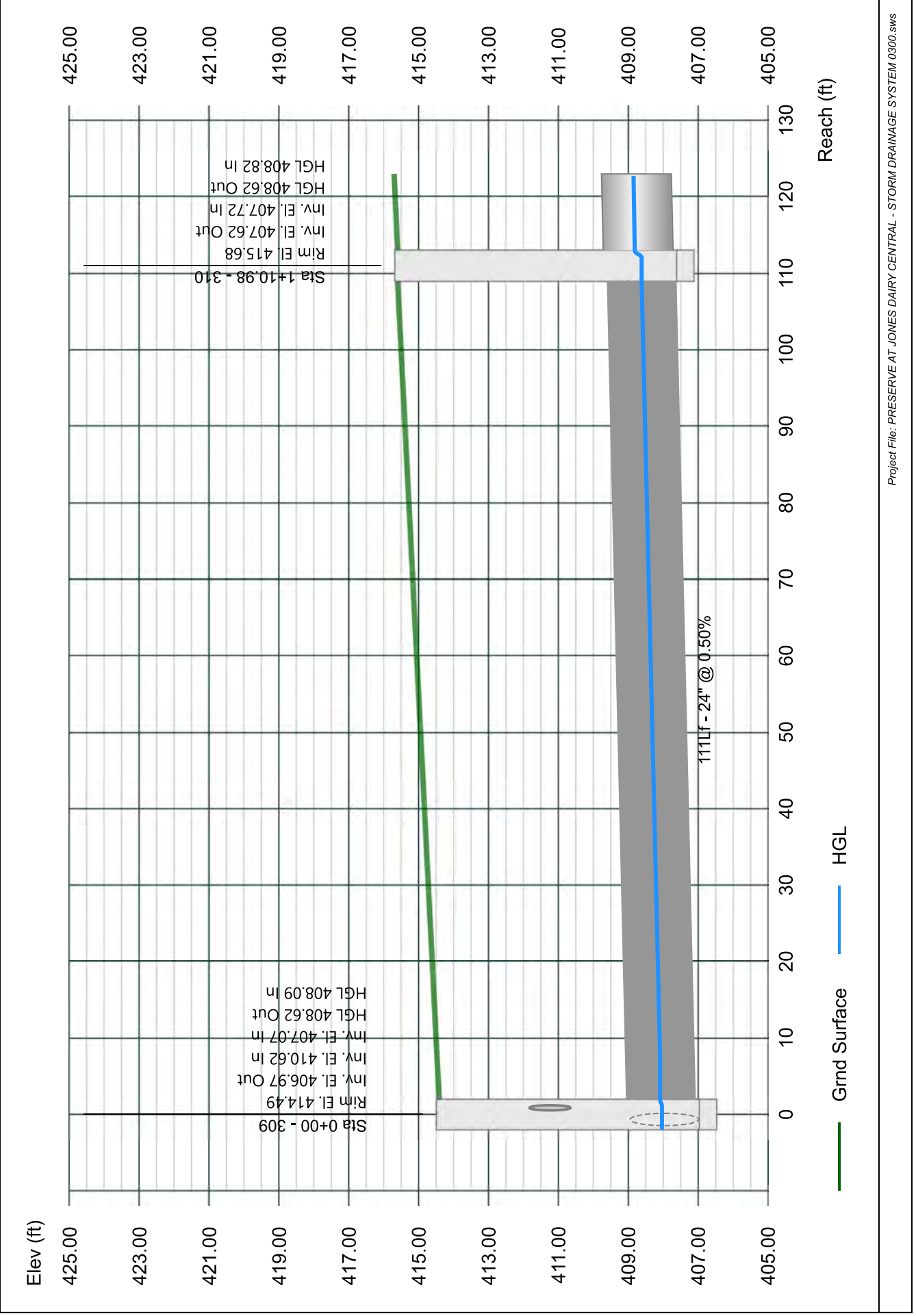

Line 15 - 311 TO 310

Stormwater Studio 2023 v 3.0.0.31

Project Name: Enter Project Name...

05-03-2023

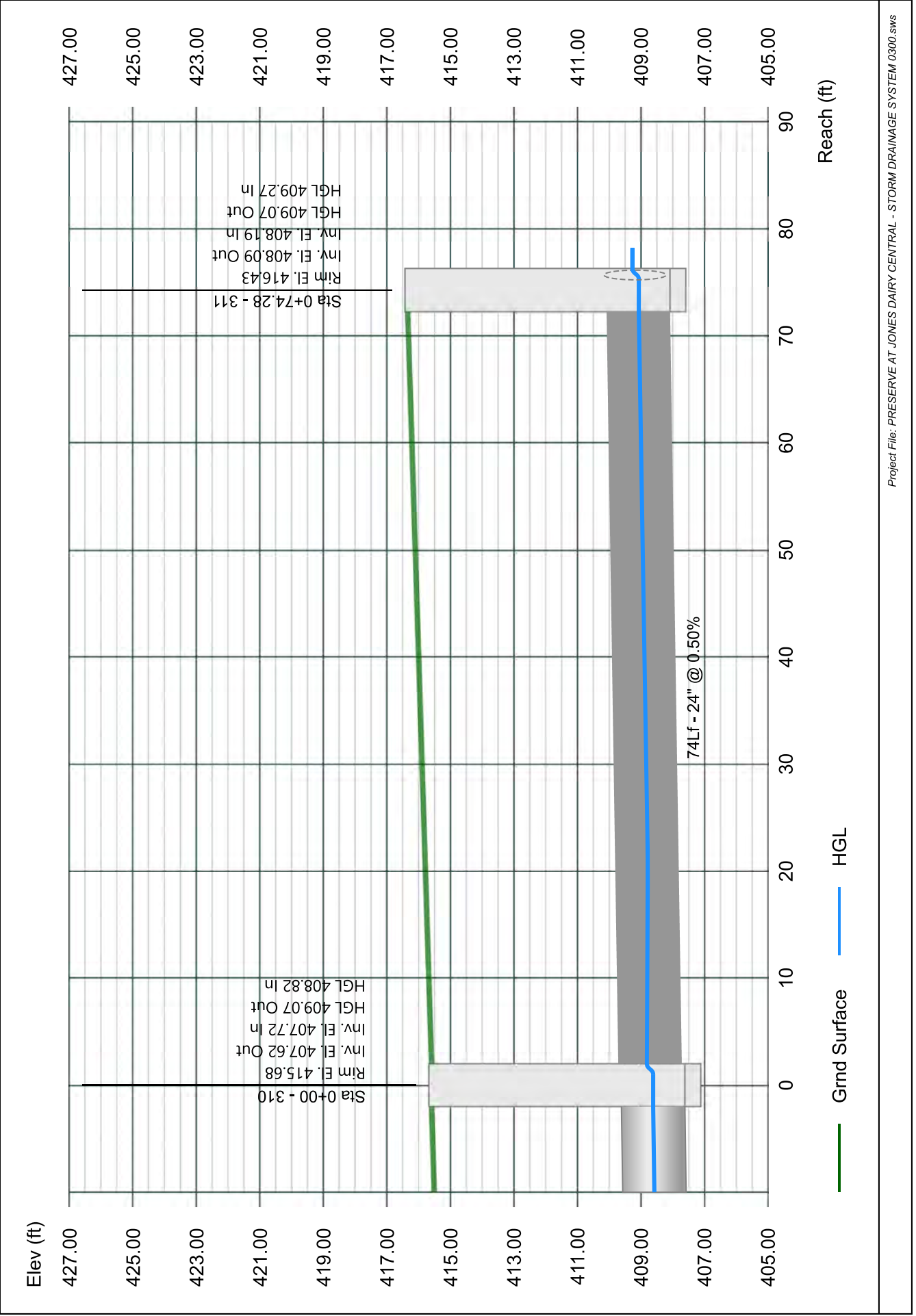

Line 16 - 312 TO 311

Stormwater Studio 2023 v 3.0.0.31

Project Name: Enter Project Name...

05-03-2023

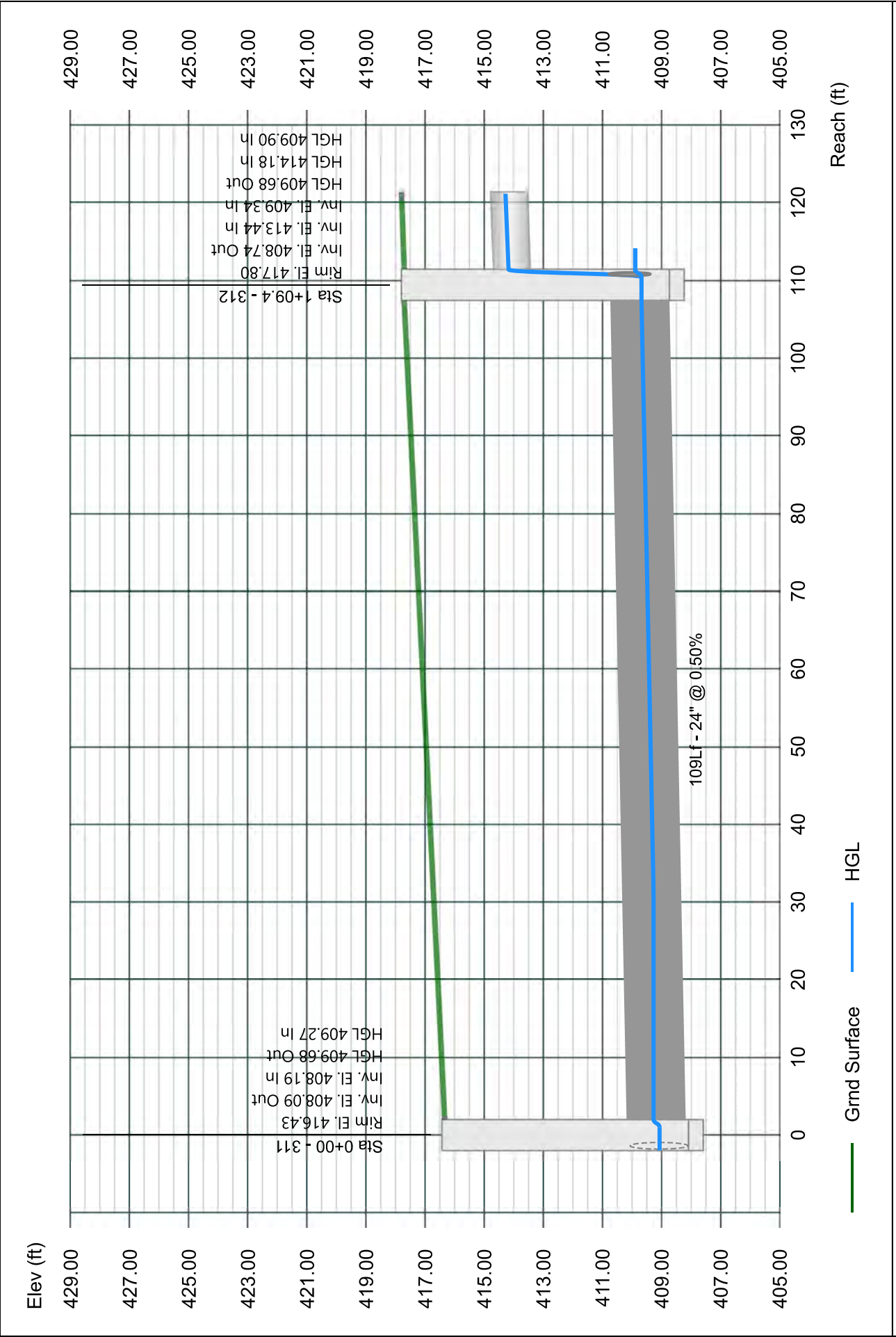

Line 17 - 364 TO 312

Stormwater Studio 2023 v 3.0.0.31

Project Name: Enter Project Name...

05-03-2023

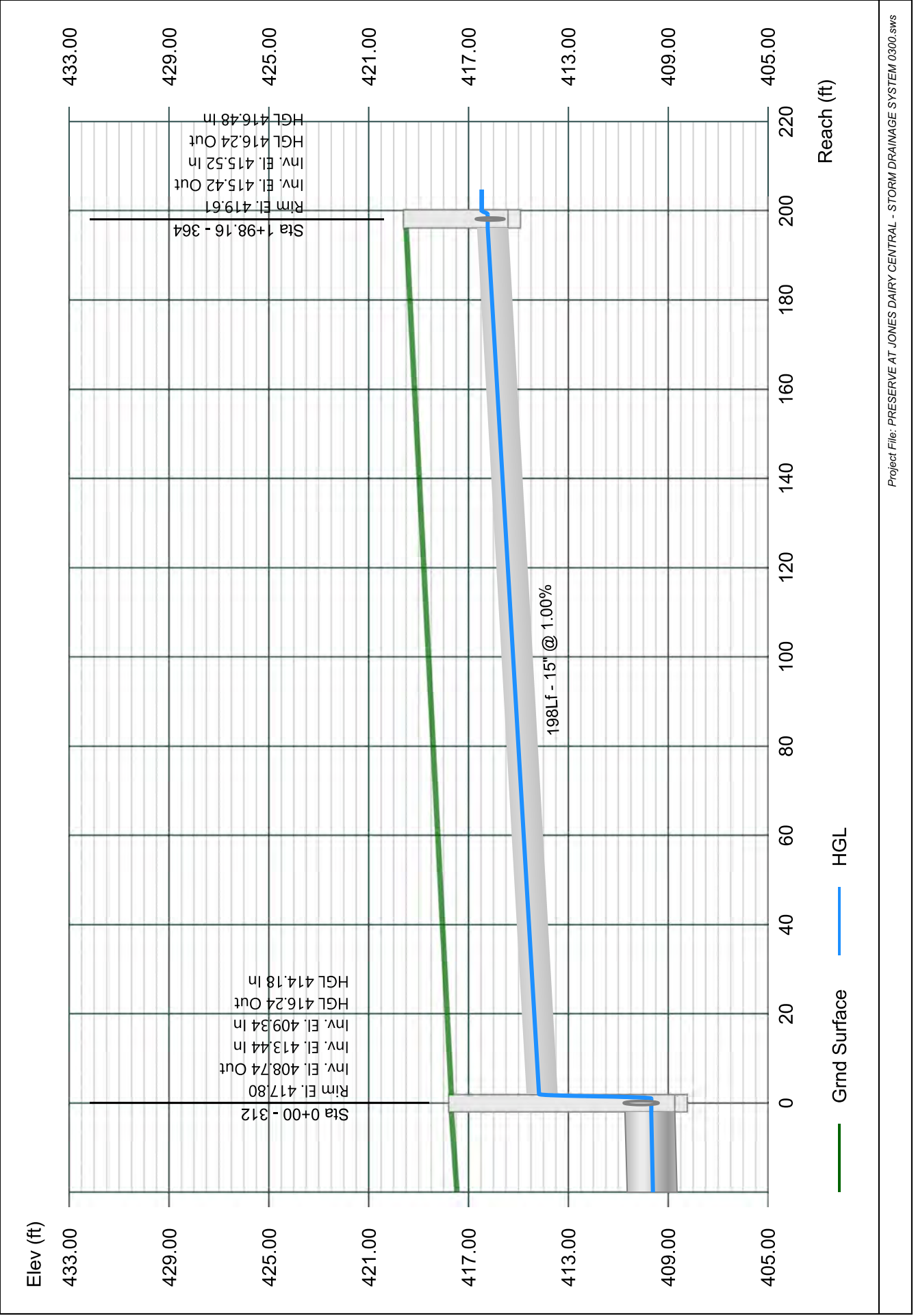

Line 18 - 365 TO 364

Stormwater Studio 2023 v 3.0.0.31

Project Name: Enter Project Name...

05-03-2023

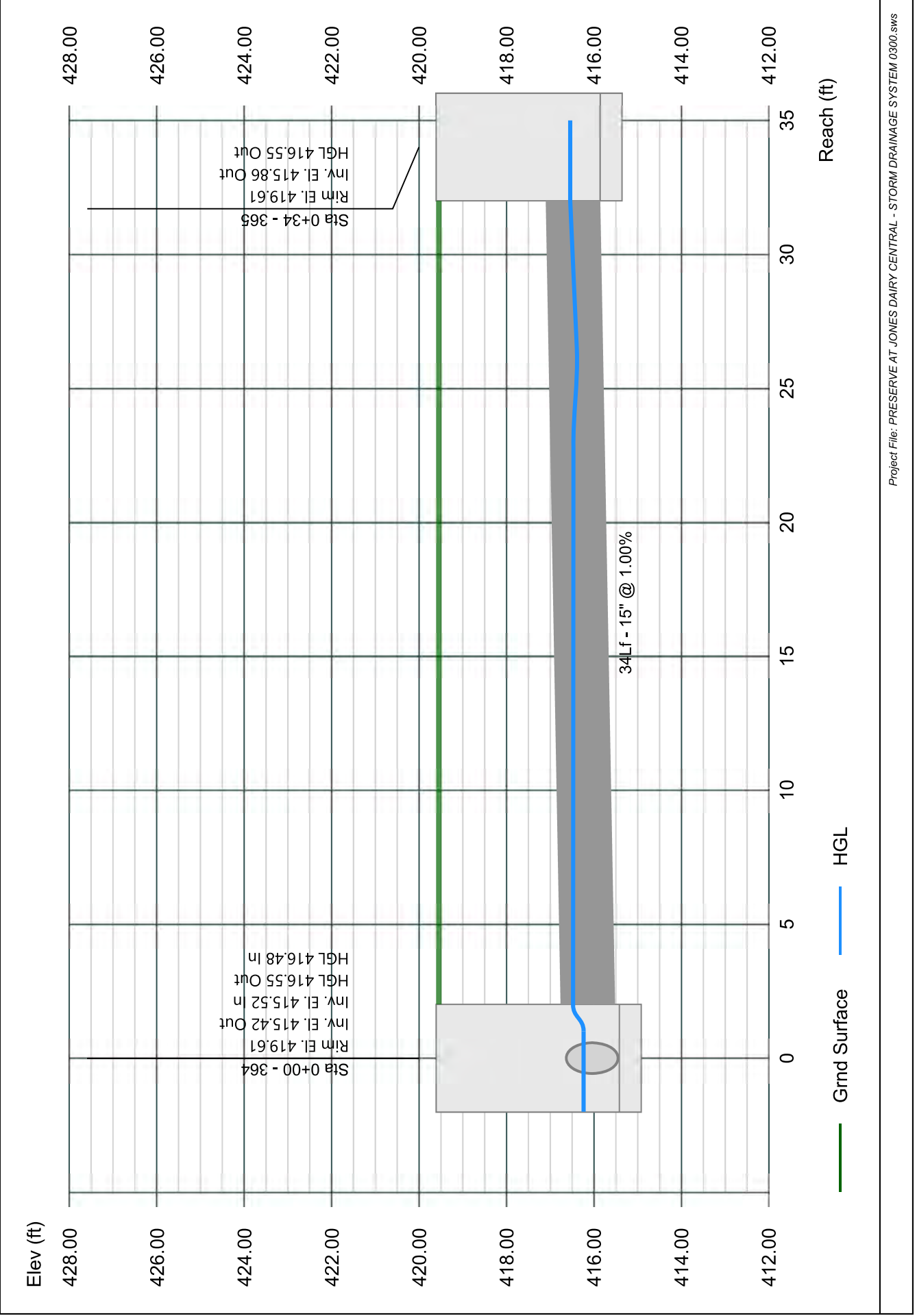

Line 19 - 313 TO 312

Stormwater Studio 2023 v 3.0.0.31

Project Name: Enter Project Name...

05-03-2023

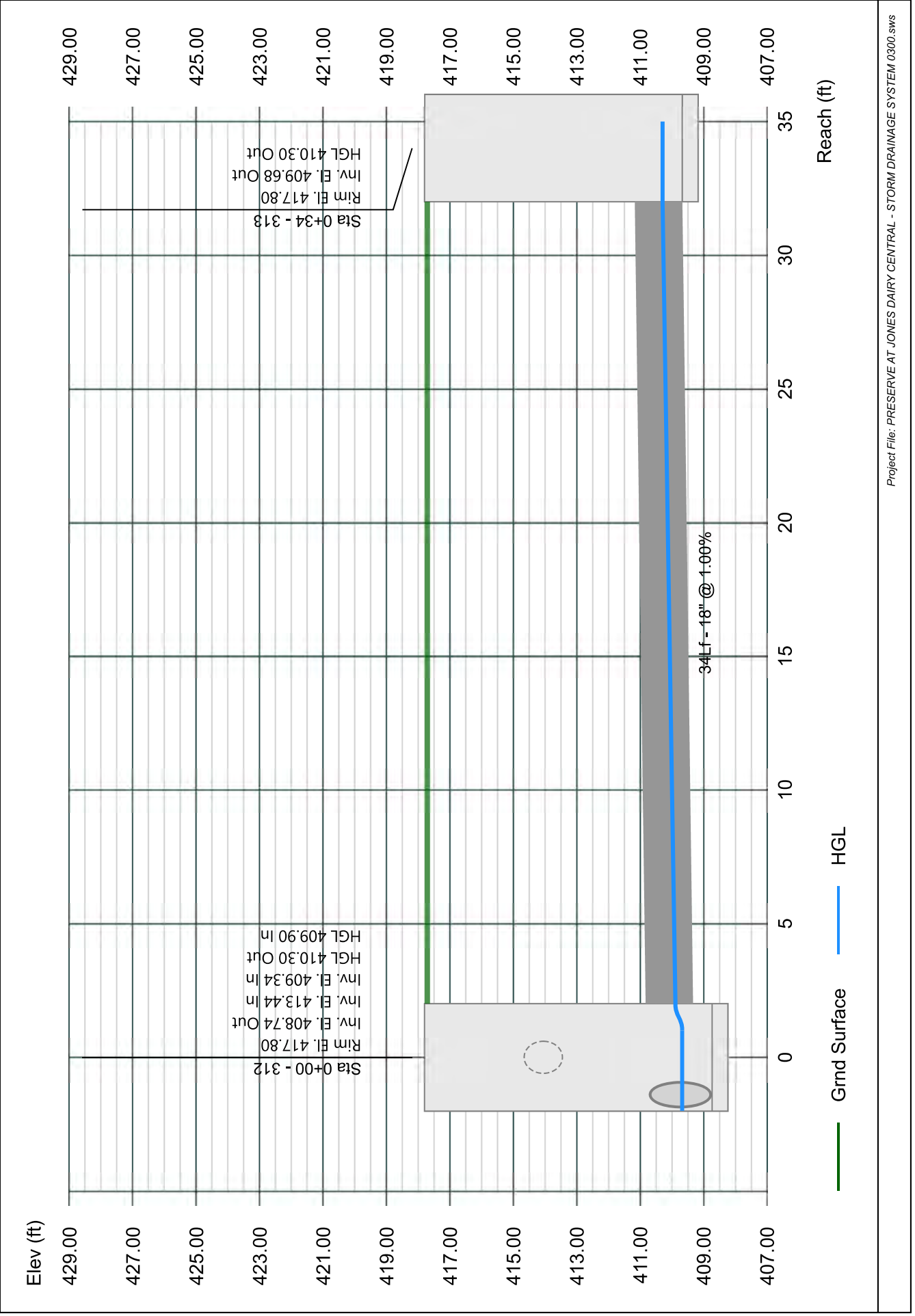

Line 20 - 360 TO 308

Stormwater Studio 2023 v 3.0.0.31

Project Name: Enter Project Name...

05-03-2023

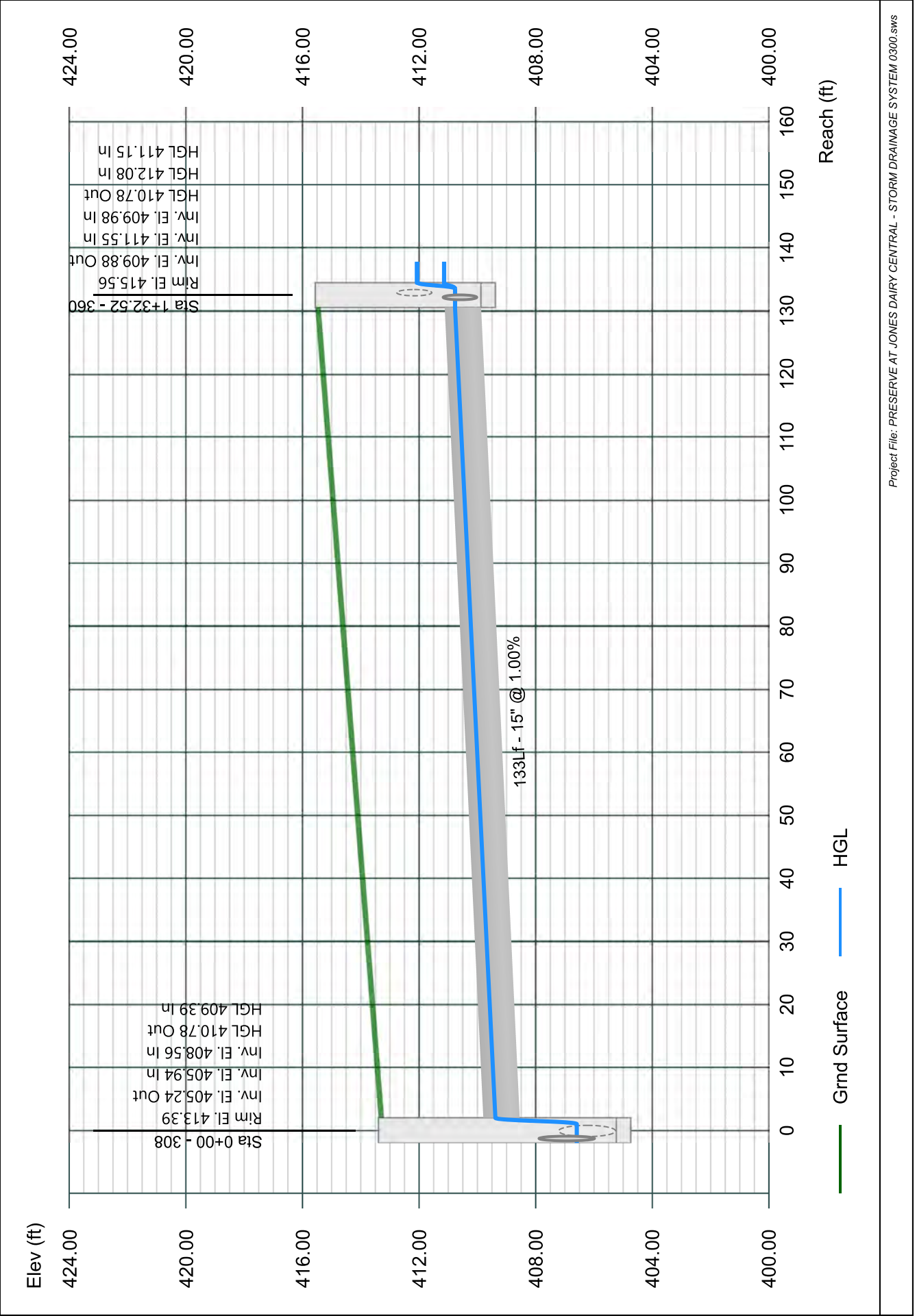

Line 21 - 361 TO 360

Stormwater Studio 2023 v 3.0.0.31

Project Name: Enter Project Name...

05-03-2023

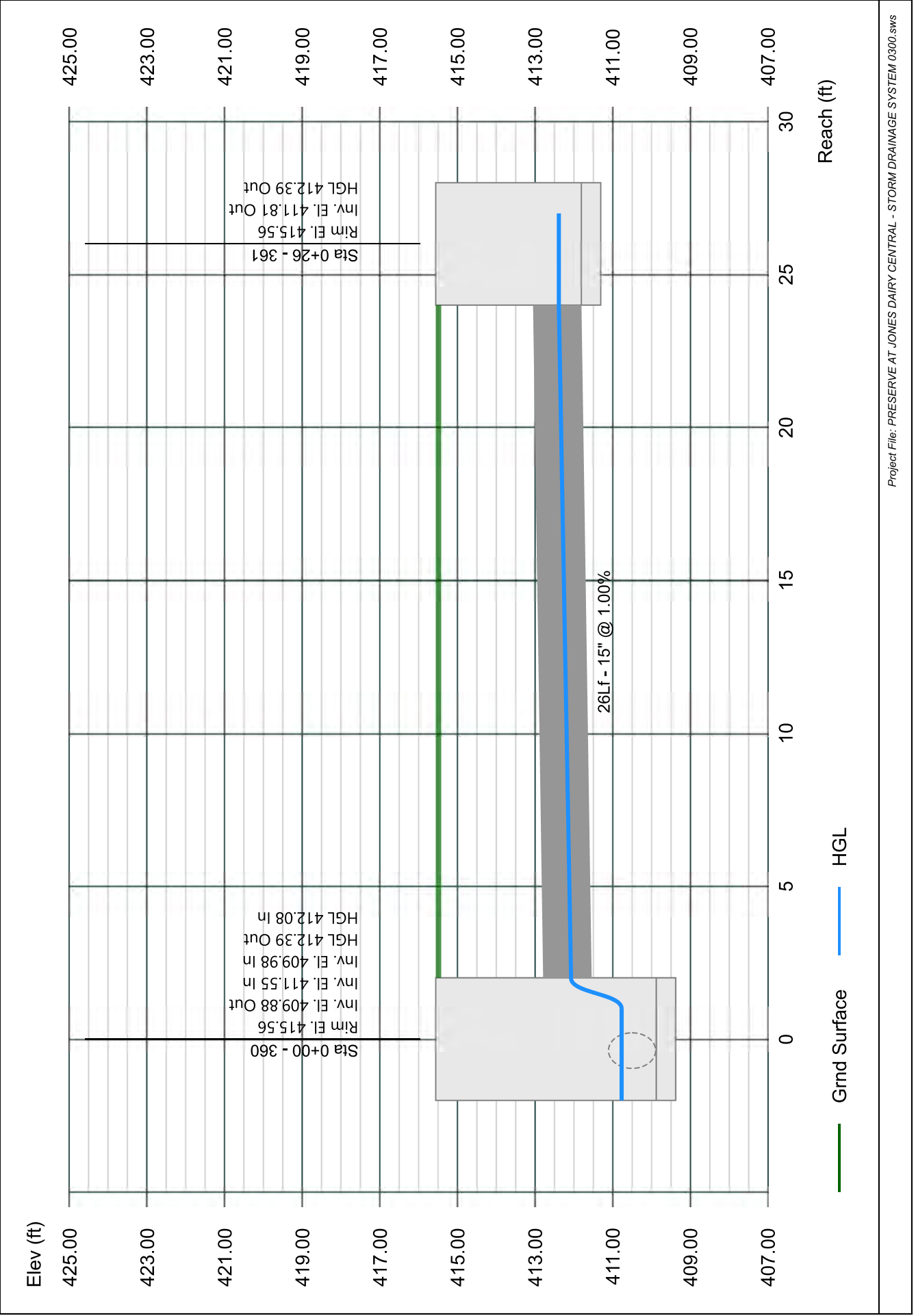

Line 22 - 362 TO 360

Stormwater Studio 2023 v 3.0.0.31

Project Name: Enter Project Name...

05-03-2023

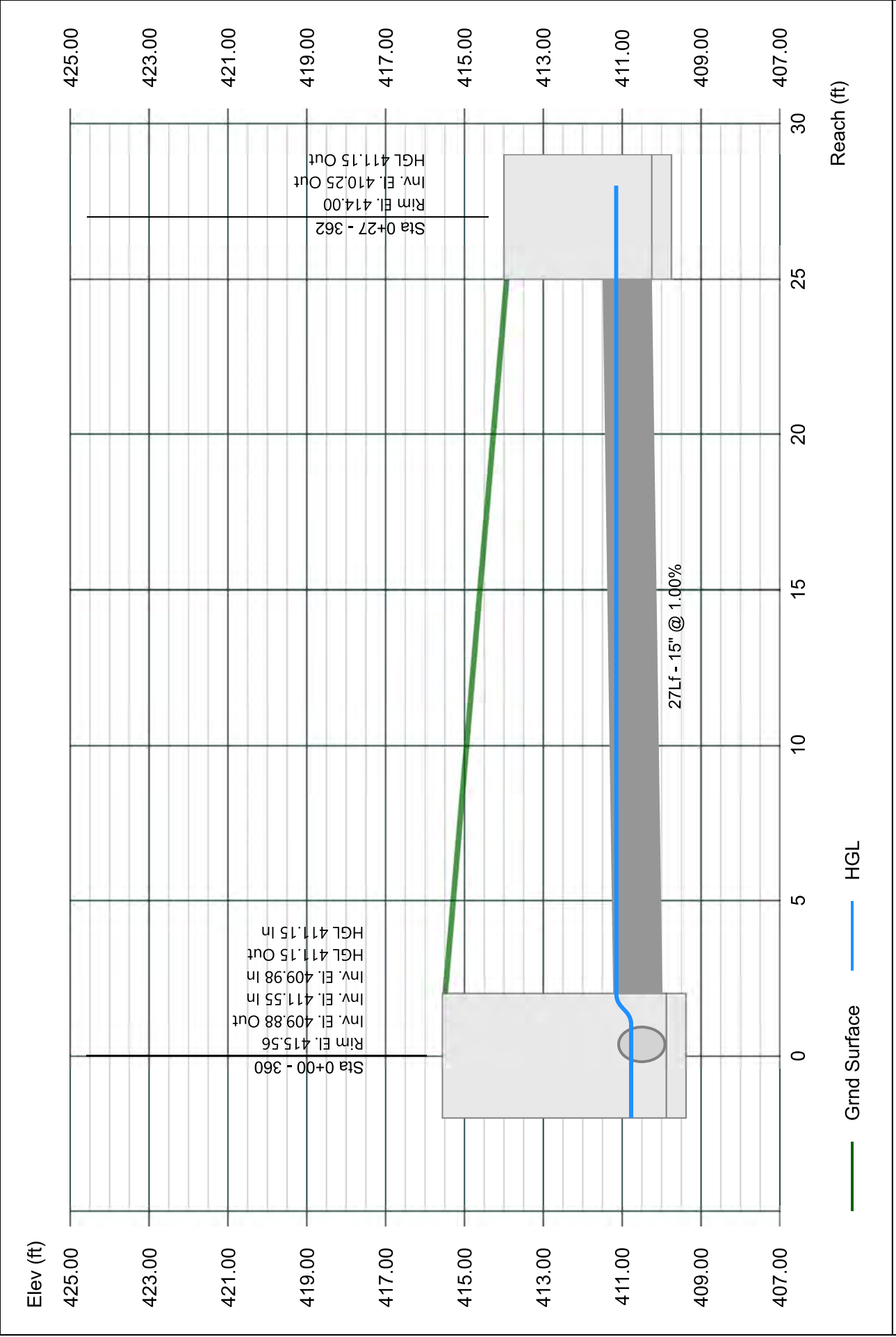

Line 23 - 356 TO 305

Stormwater Studio 2023 v 3.0.0.31

Project Name: Enter Project Name...

05-03-2023

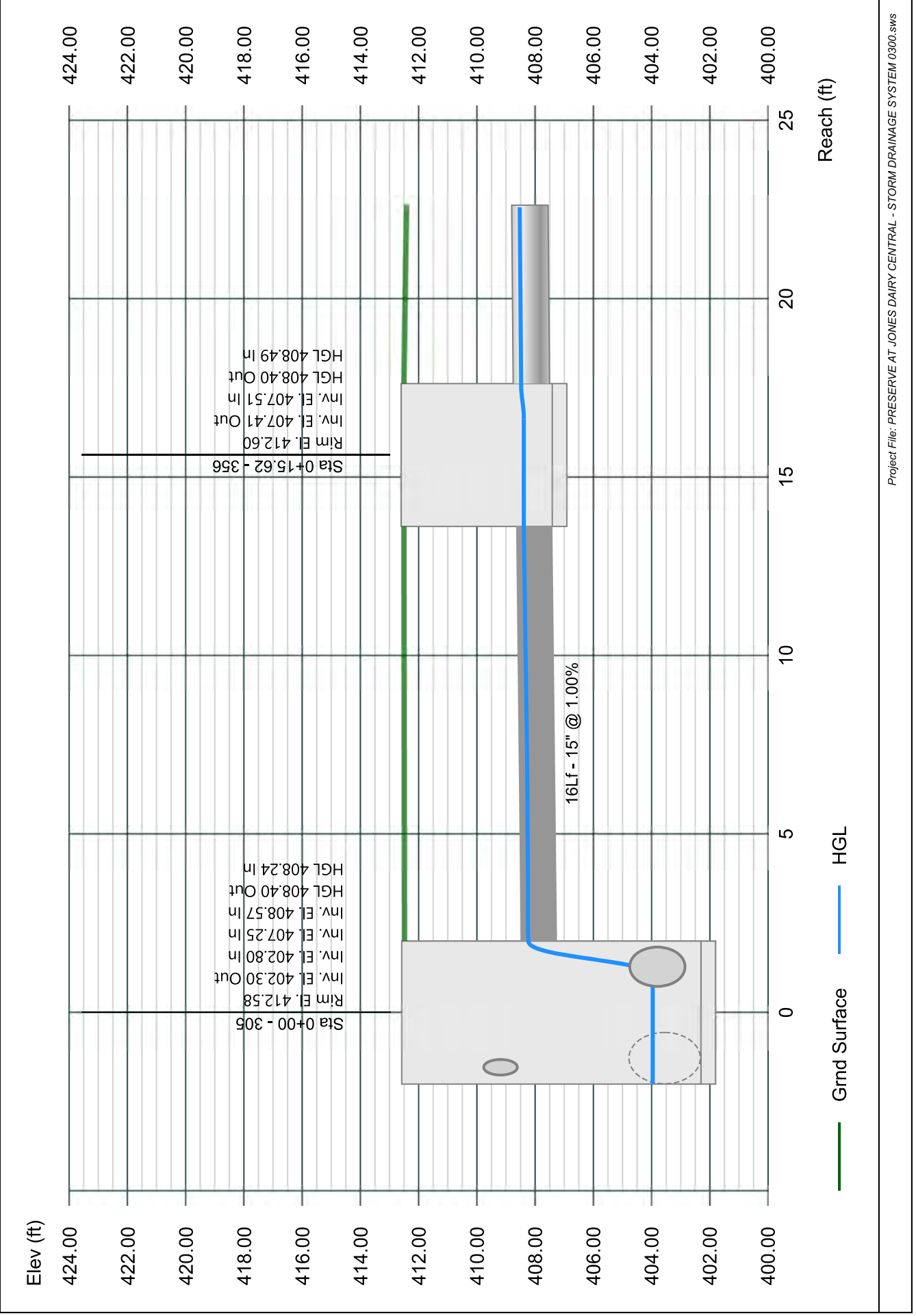

Line 24 - 357 TO 356

Stormwater Studio 2023 v 3.0.0.31

Project Name: Enter Project Name...

05-03-2023

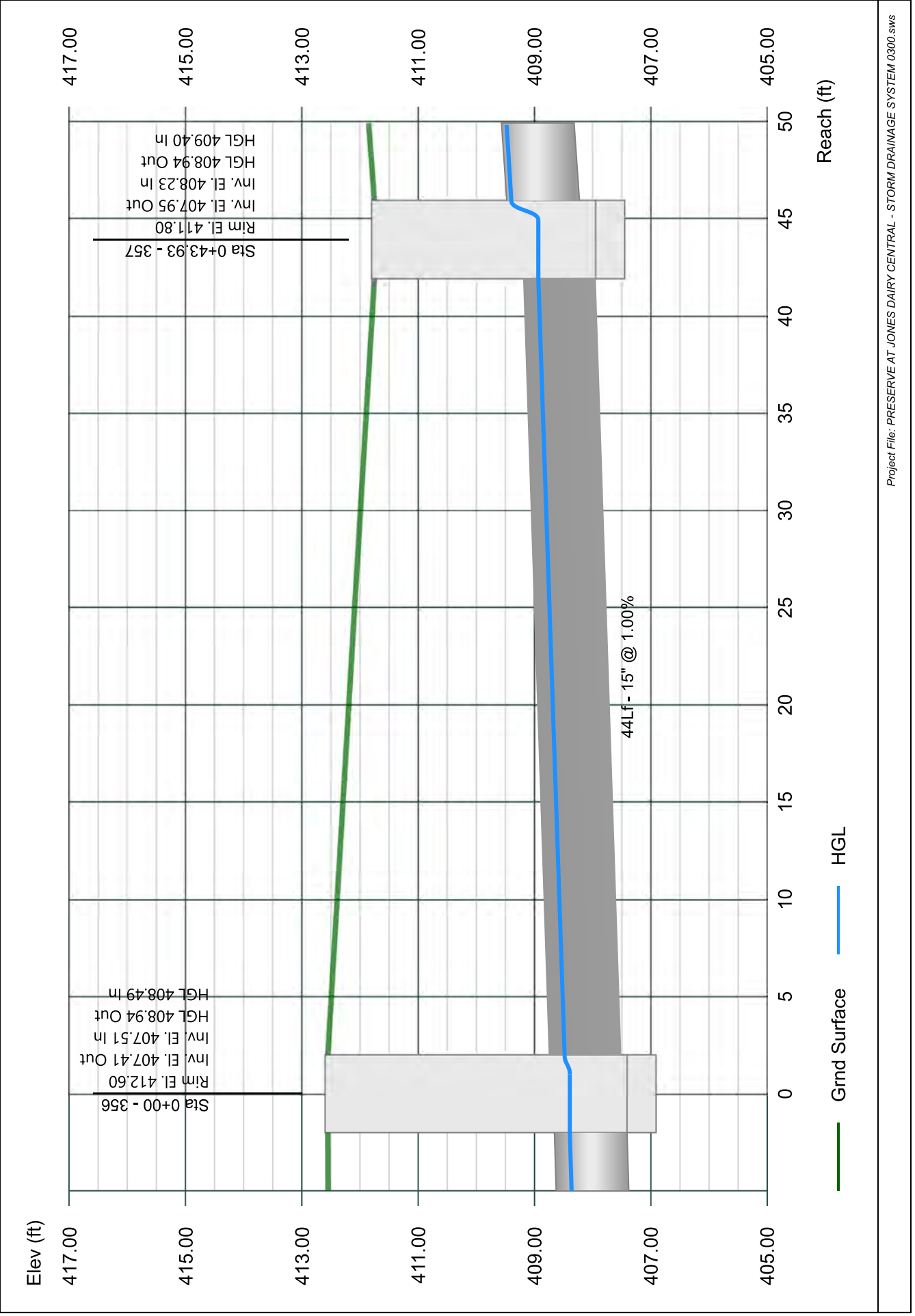

Line 25 - 358 TO 357

Stormwater Studio 2023 v 3.0.0.31

Project Name: Enter Project Name...

05-03-2023

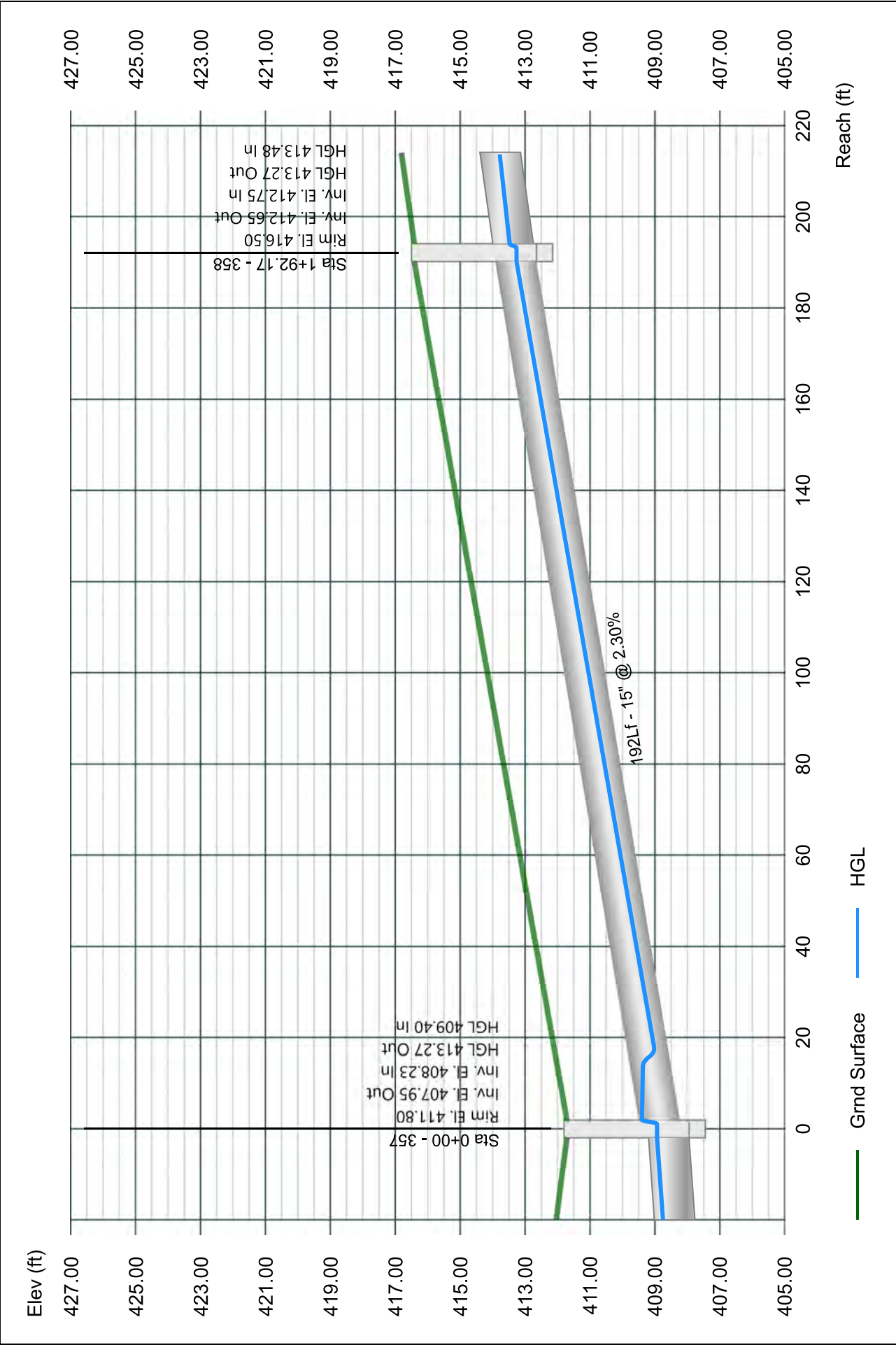

Line 26 - 359 TO 358

Stormwater Studio 2023 v 3.0.0.31

Project Name: Enter Project Name...

05-03-2023

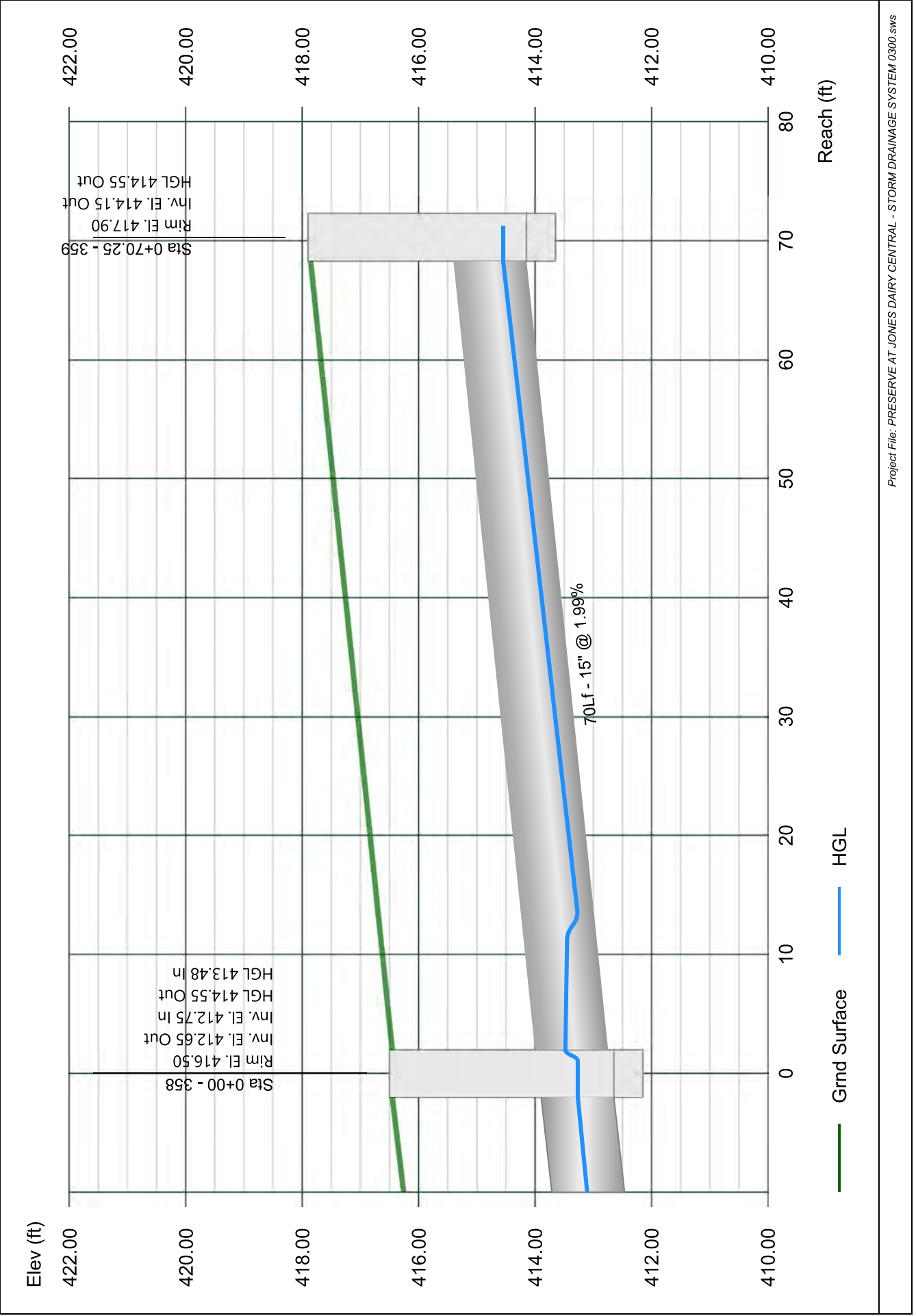

Line 27 - 355 TO 305

Stormwater Studio 2023 v 3.0.0.31

Project Name: Enter Project Name...

05-03-2023

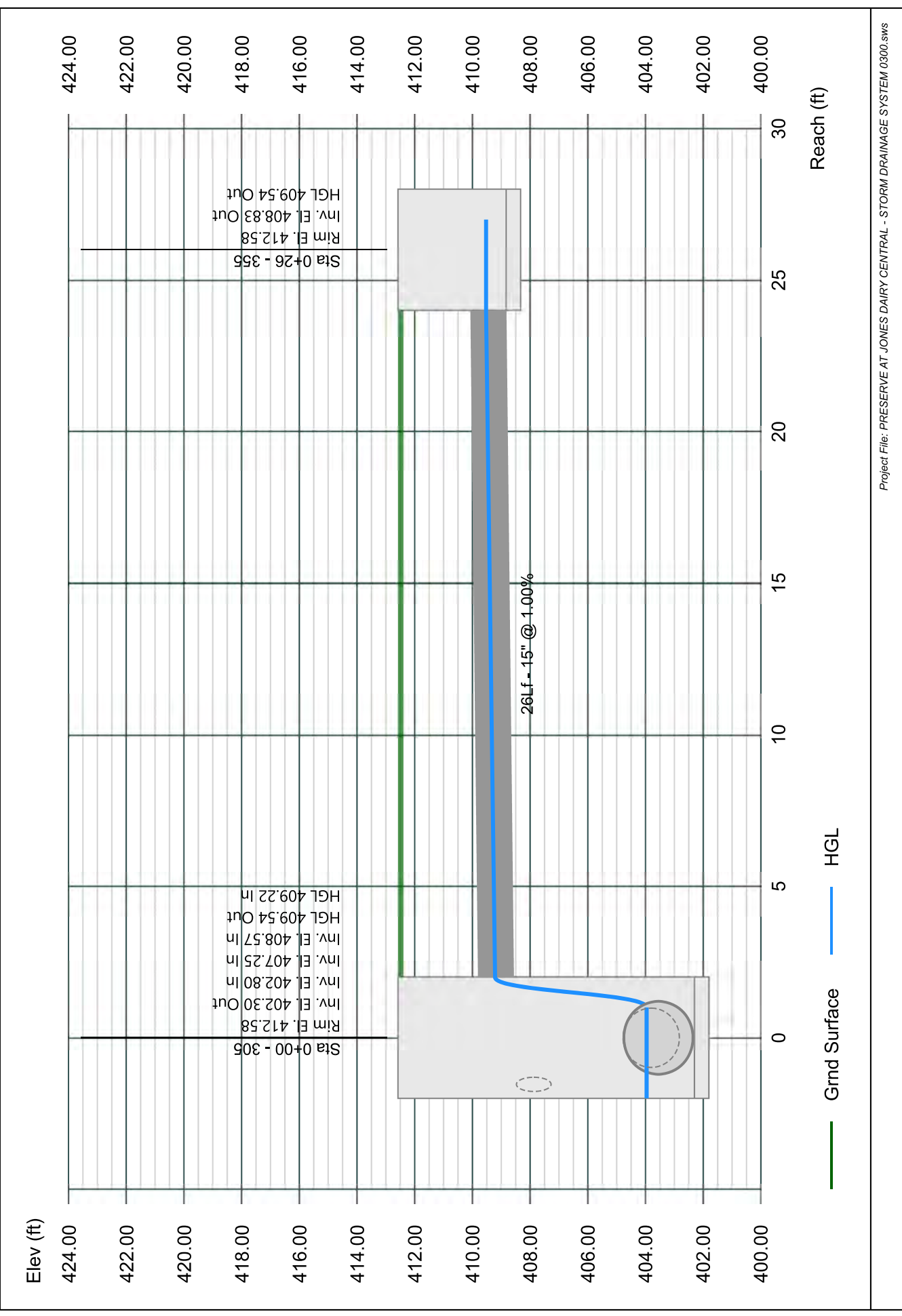

Line 28 - 338 TO 304

Stormwater Studio 2023 v 3.0.0.31

Project Name: Enter Project Name...

05-03-2023

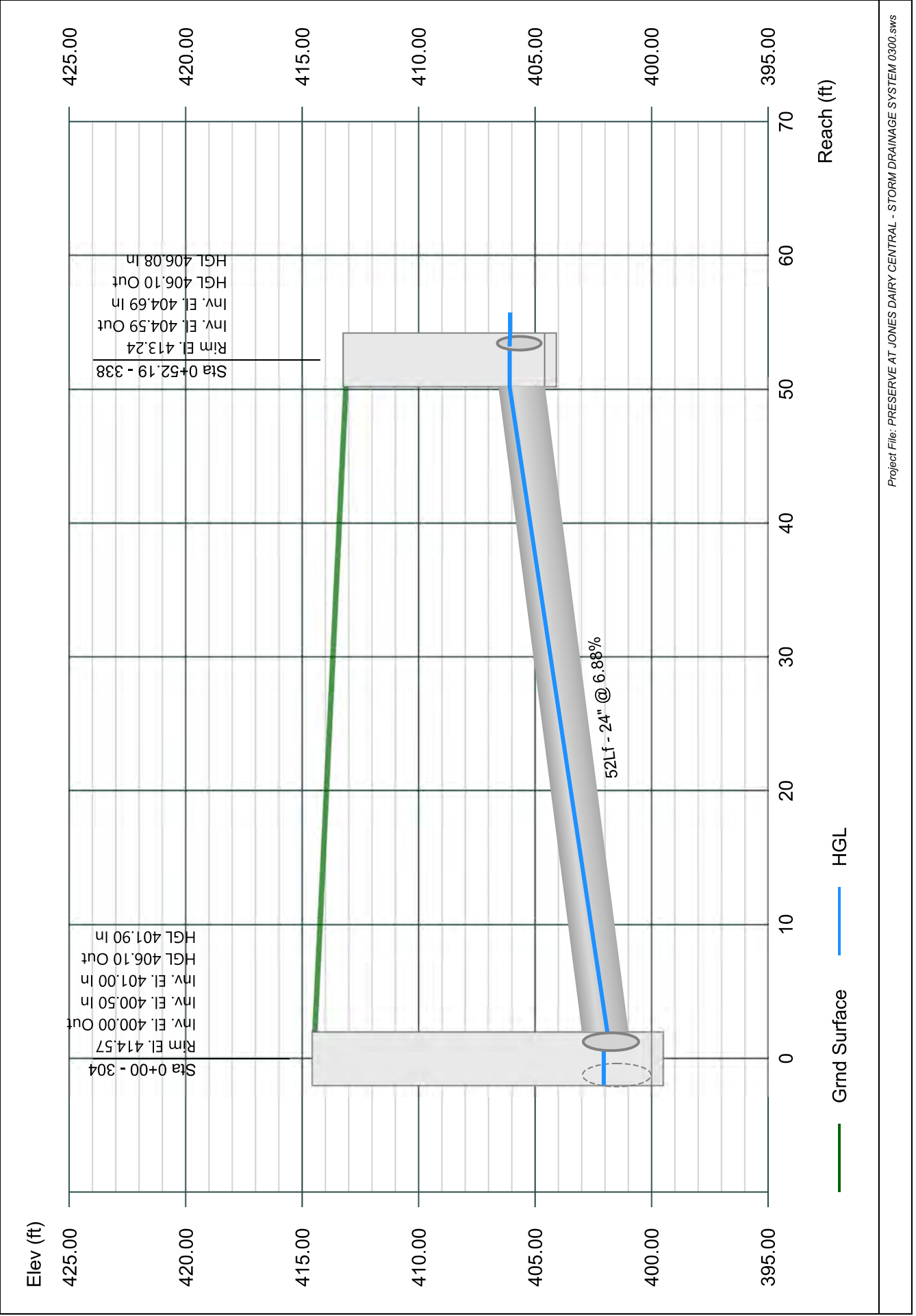

Line 29 - 339 TO 338

Stormwater Studio 2023 v 3.0.0.31

Project Name: Enter Project Name...

05-03-2023

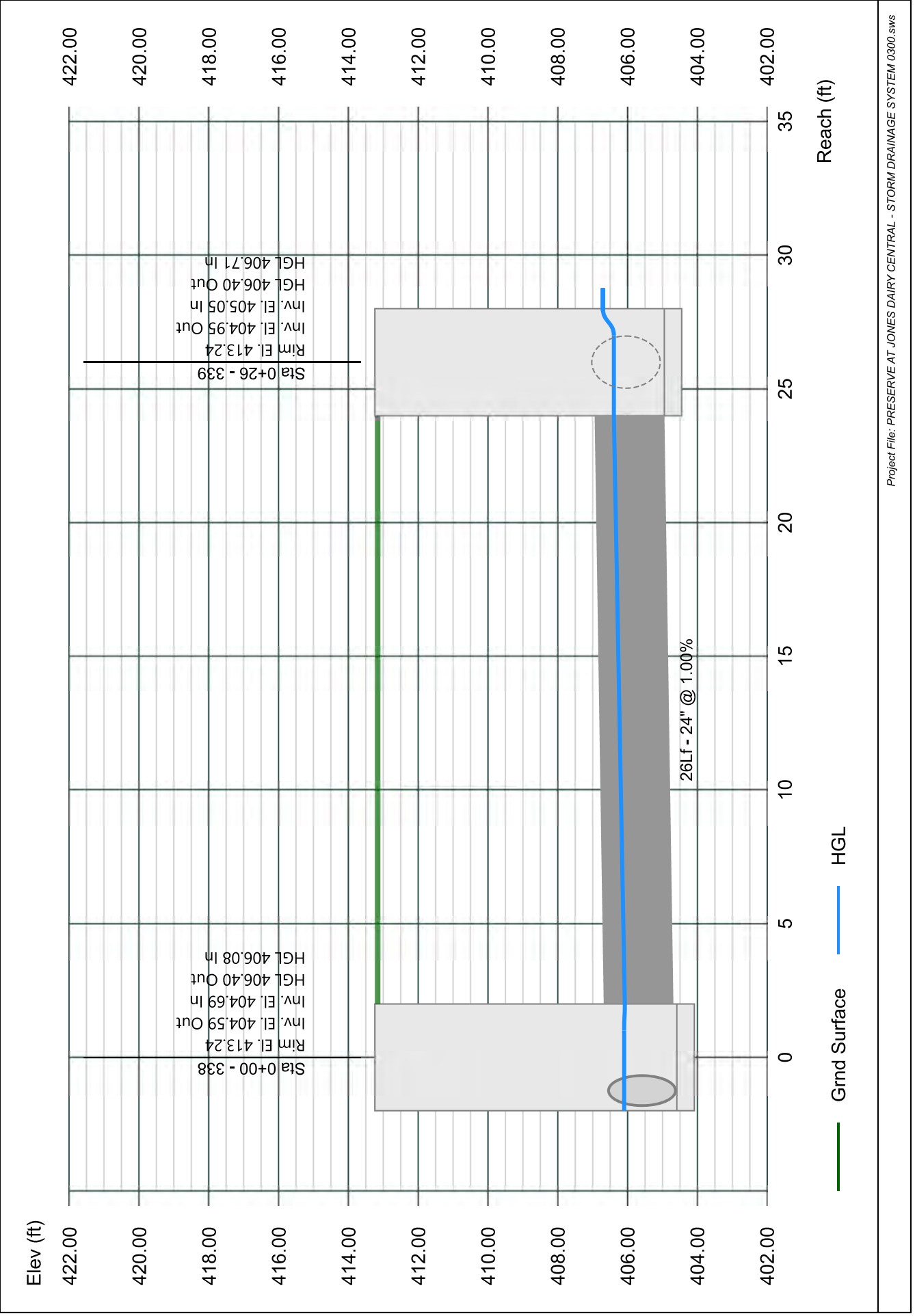

Line 30 - 340 TO 339

Stormwater Studio 2023 v 3.0.0.31

Project Name: Enter Project Name...

05-03-2023

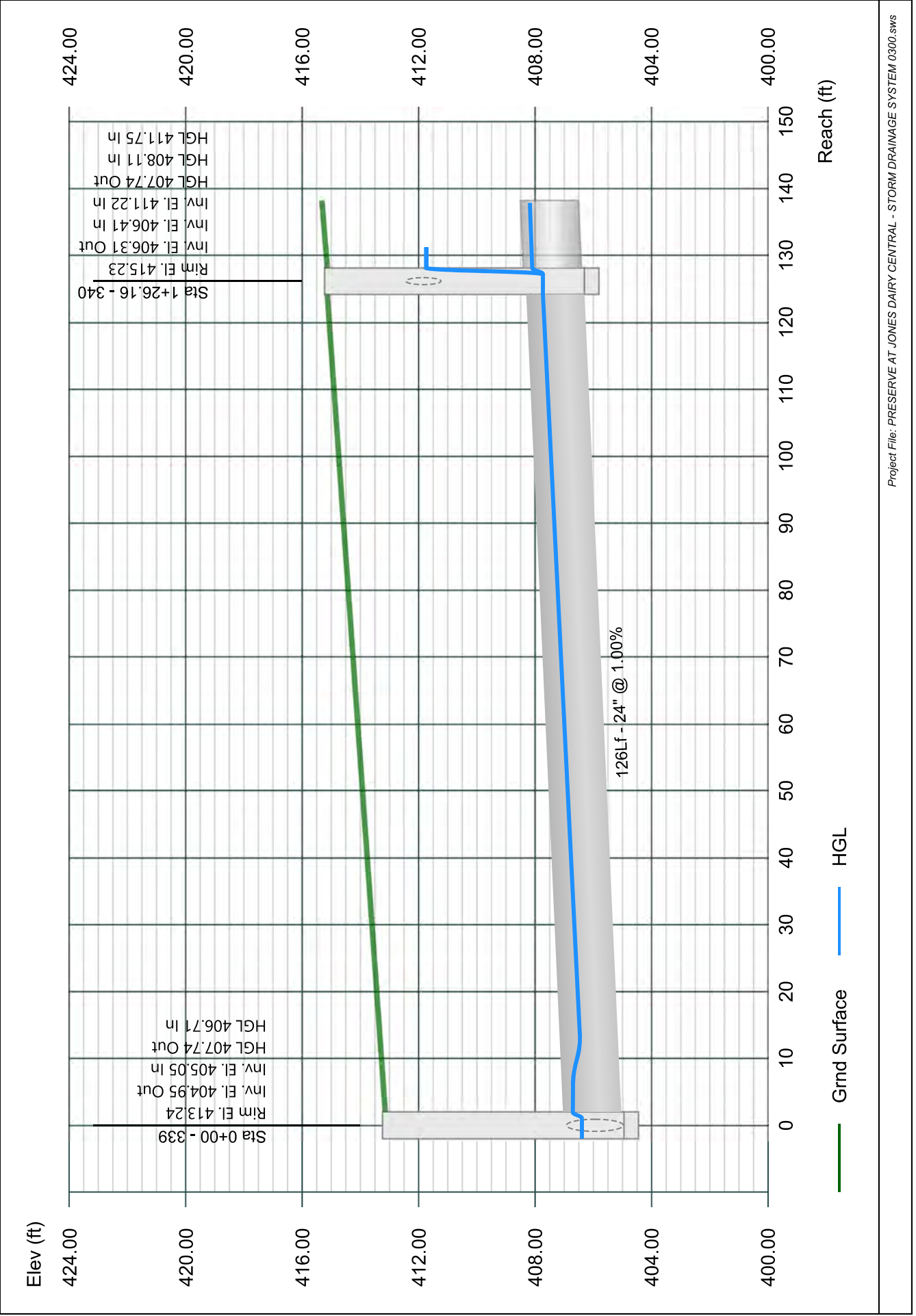

Line 31 - 341 TO 340

Stormwater Studio 2023 v 3.0.0.31

Project Name: Enter Project Name...

05-03-2023

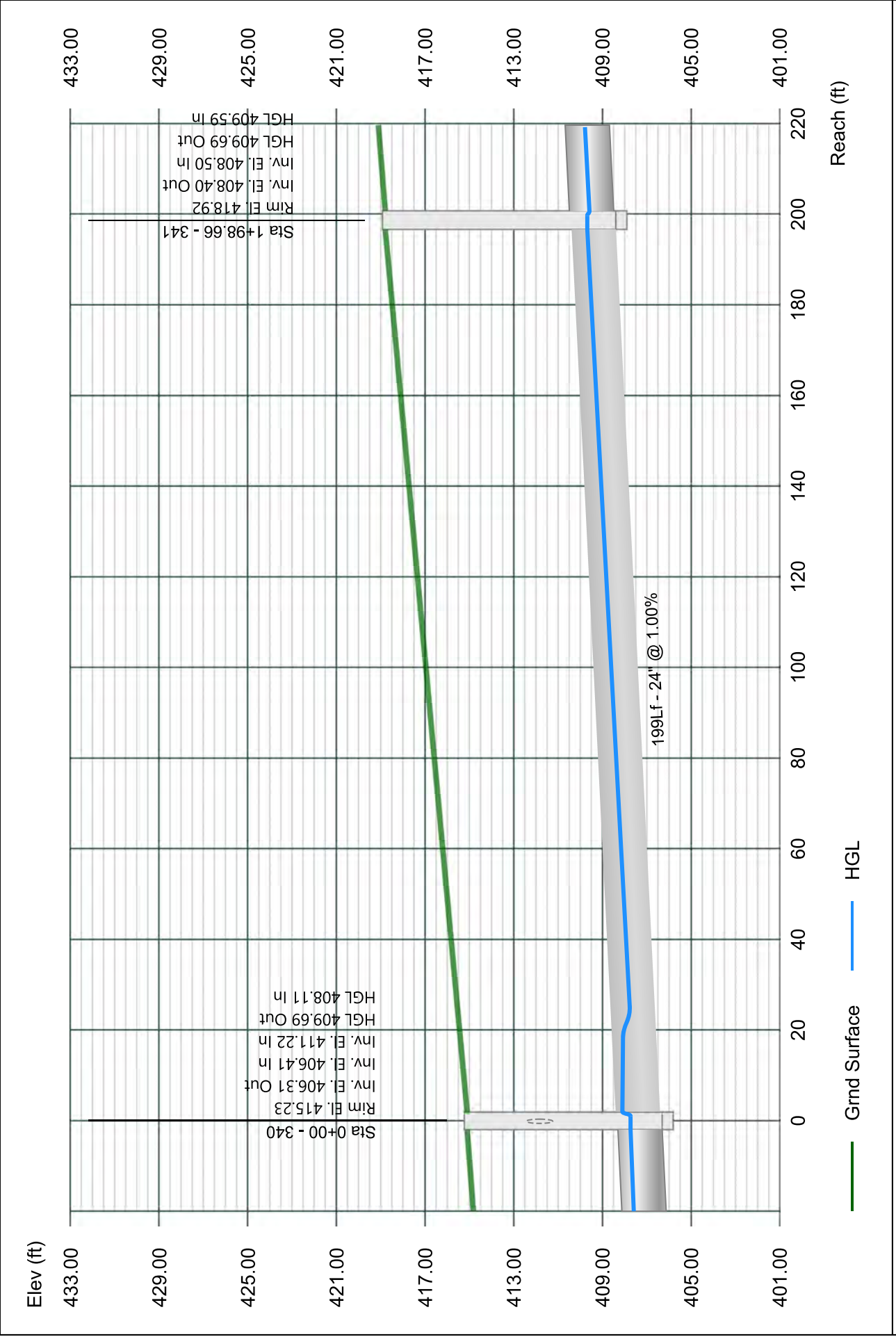

Line 32 - 342 TO 341

Stormwater Studio 2023 v 3.0.0.31

Project Name: Enter Project Name...

05-03-2023

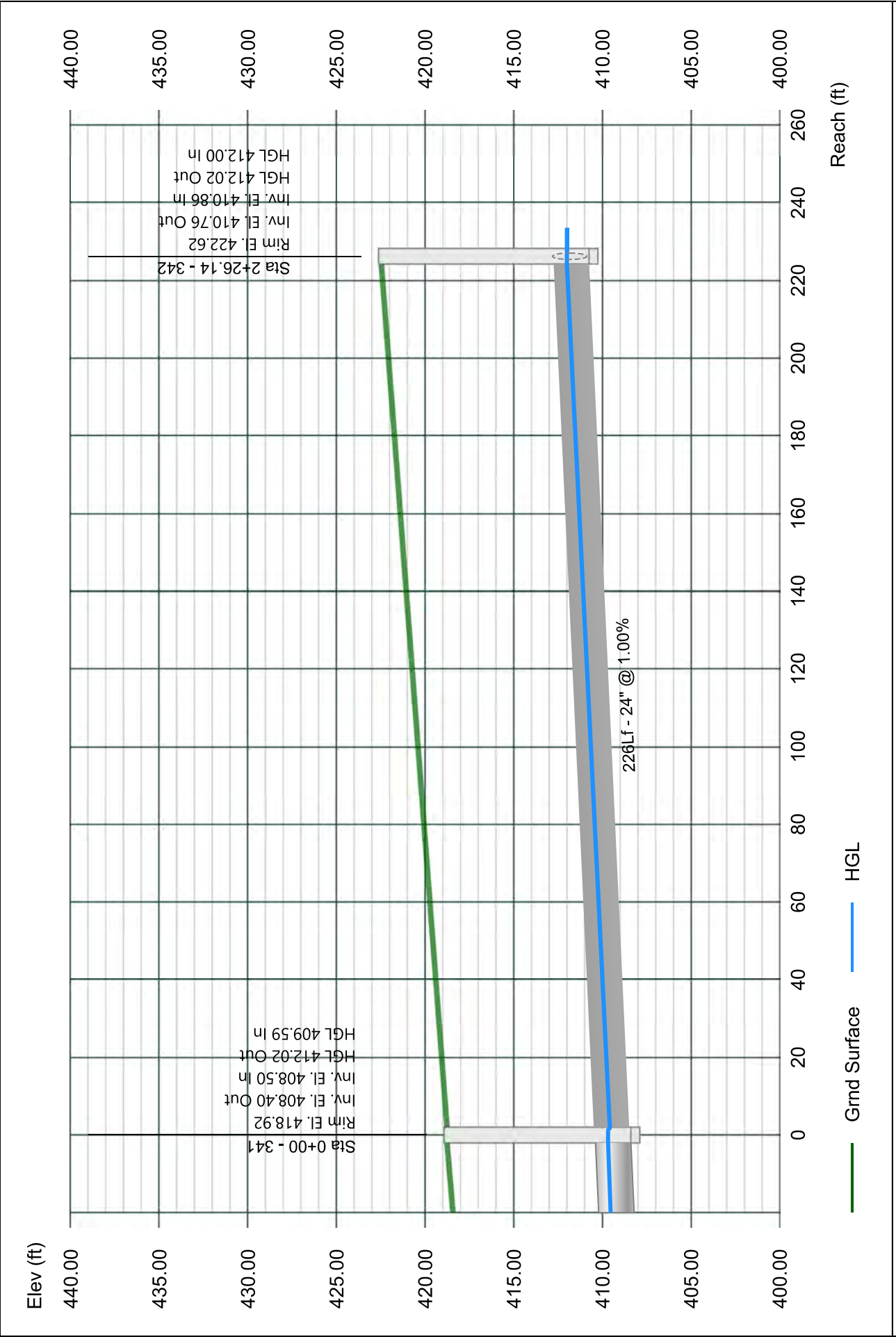

Line 33 - 343 TO 342

Stormwater Studio 2023 v 3.0.0.31

Project Name: Enter Project Name...

05-03-2023

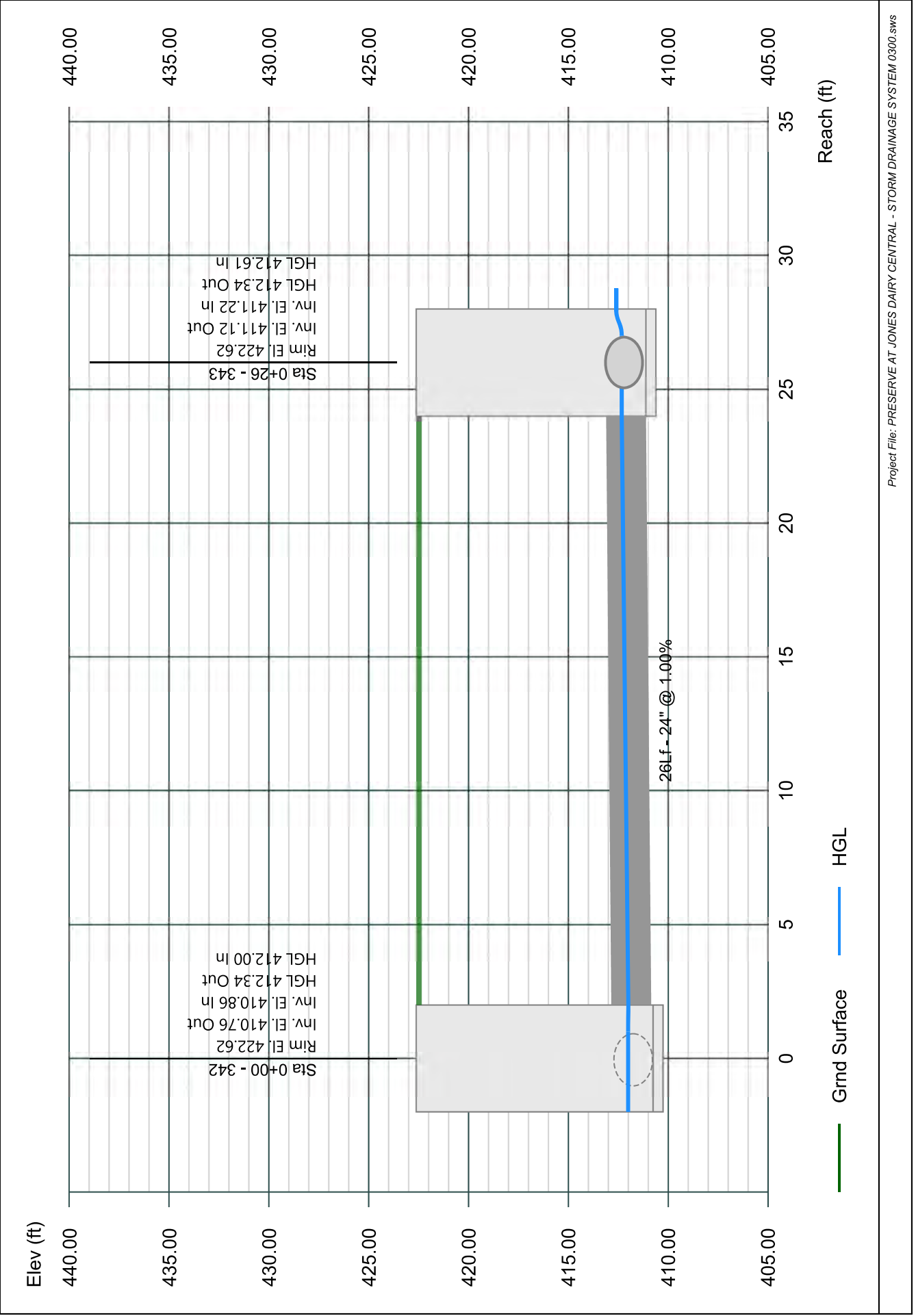

Line 34 - 343A TO 343

Stormwater Studio 2023 v 3.0.0.31

Project Name: Enter Project Name...

05-03-2023

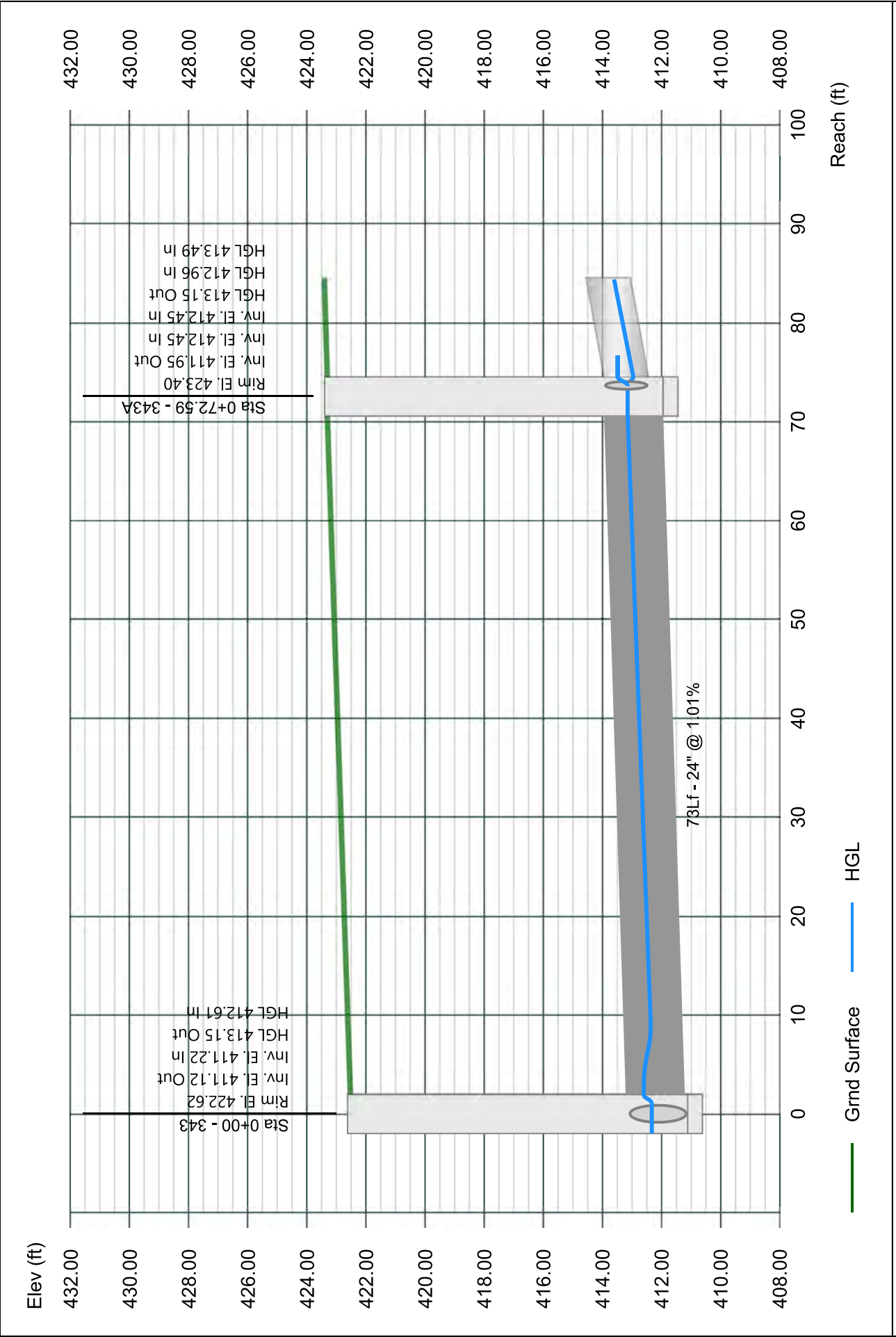

Line 35 - 344 TO 343

Stormwater Studio 2023 v 3.0.0.31

Project Name: Enter Project Name...

05-03-2023

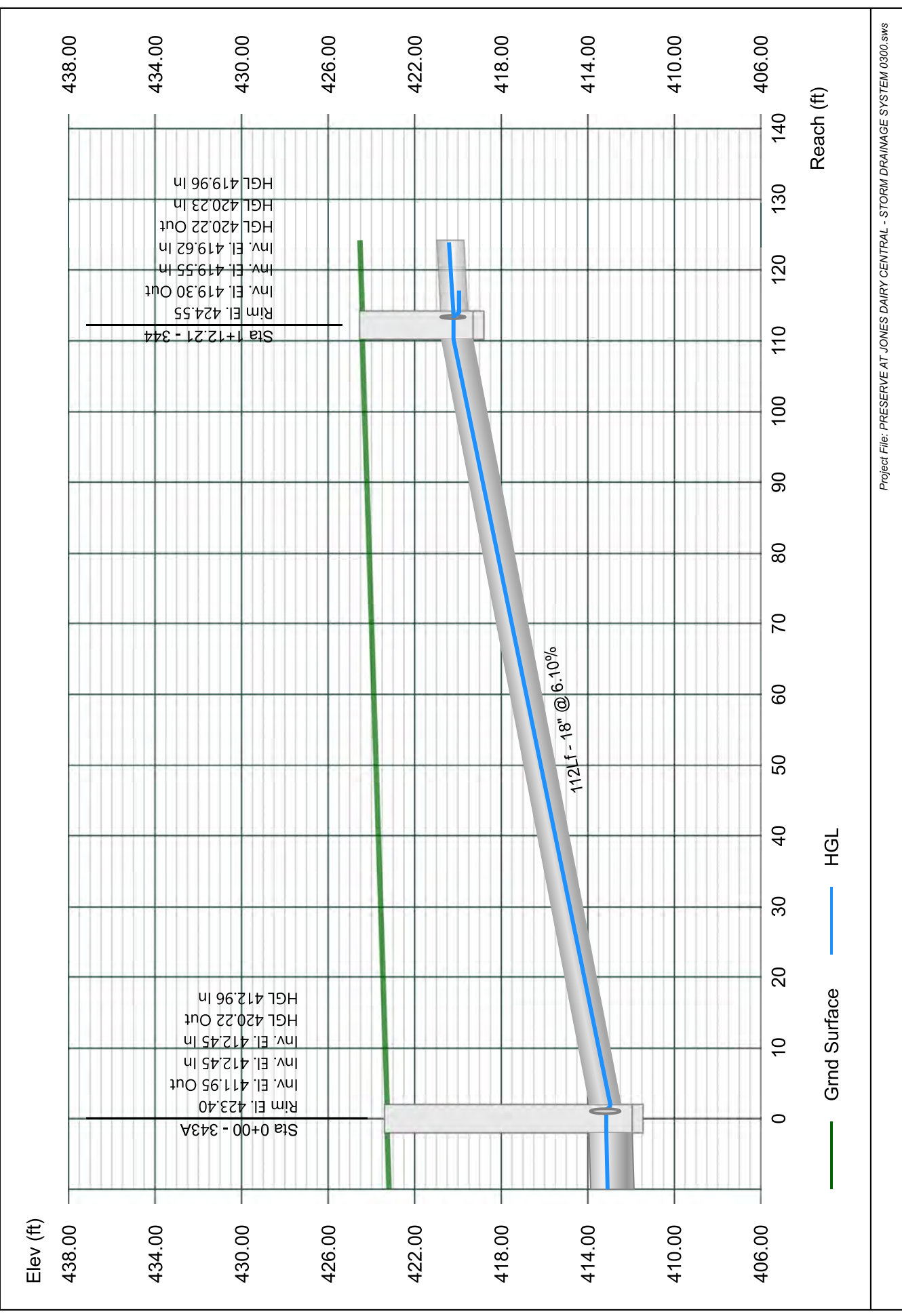

Line 36 - 345 TO 344

Stormwater Studio 2023 v 3.0.0.31

Project Name: Enter Project Name...

05-03-2023

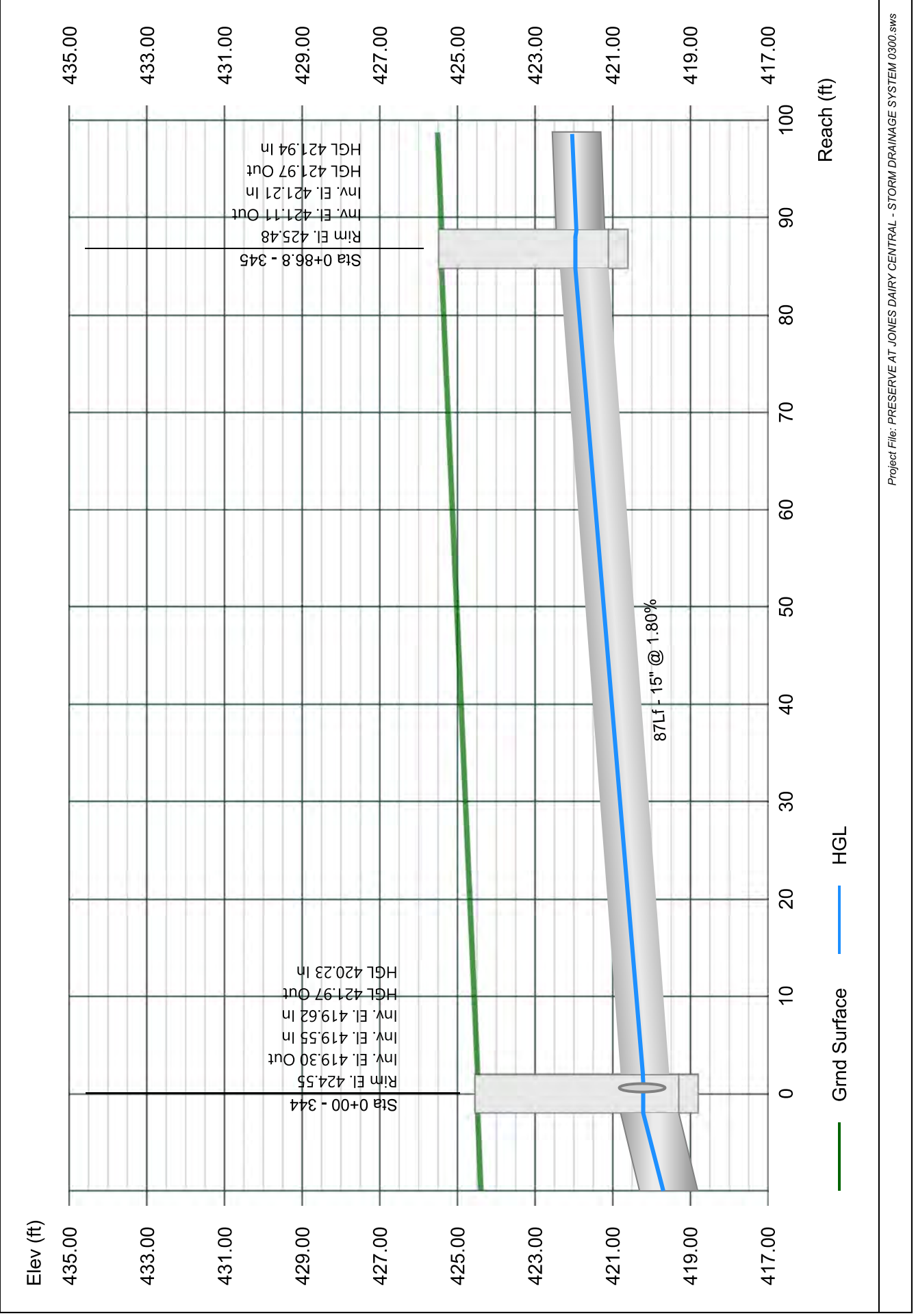

Line 37 - 346 TO 345

Stormwater Studio 2023 v 3.0.0.31

Project Name: Enter Project Name...

05-03-2023

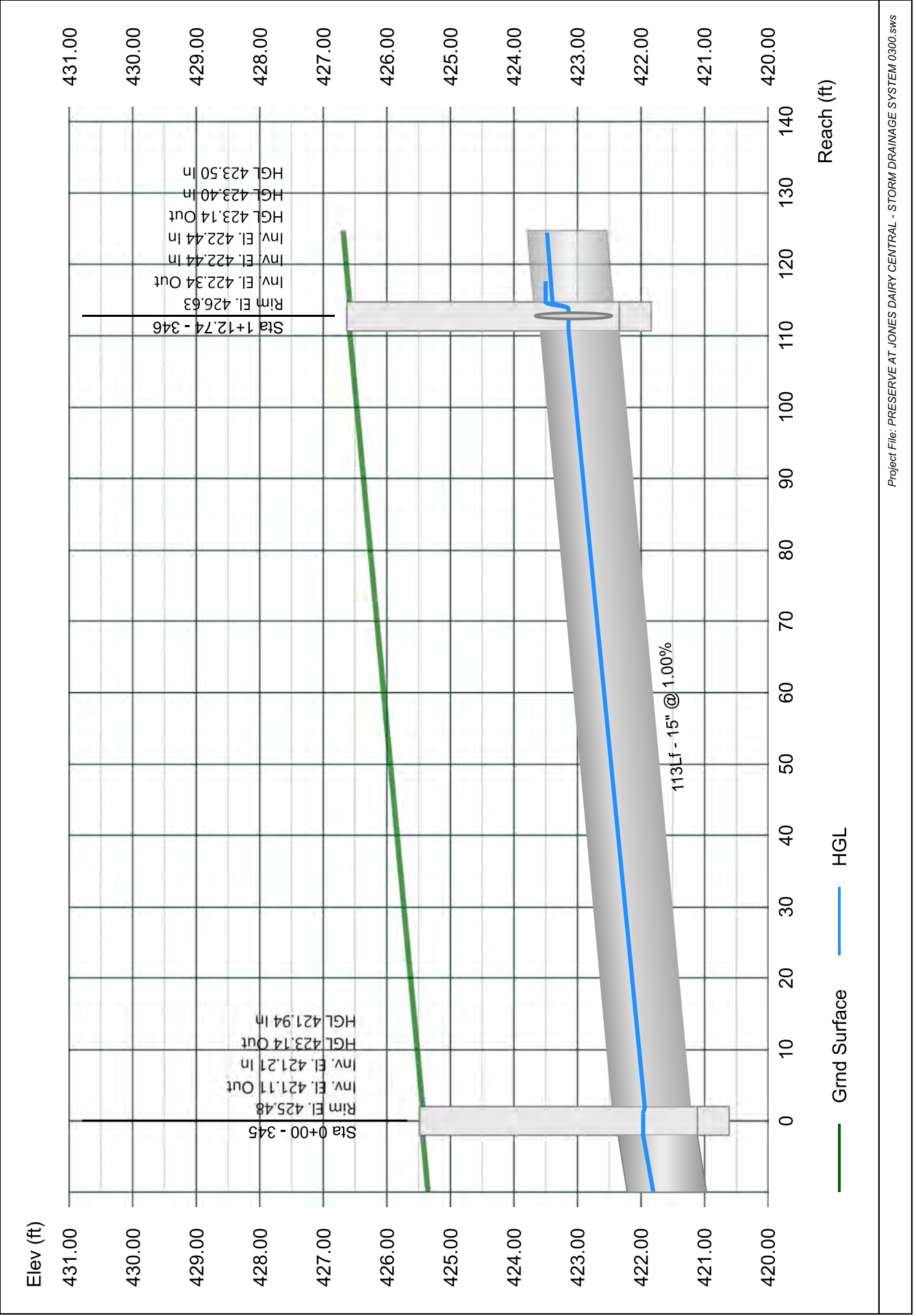

Line 38 - 347 TO 346

Stormwater Studio 2023 v 3.0.0.31

Project Name: Enter Project Name...

05-03-2023

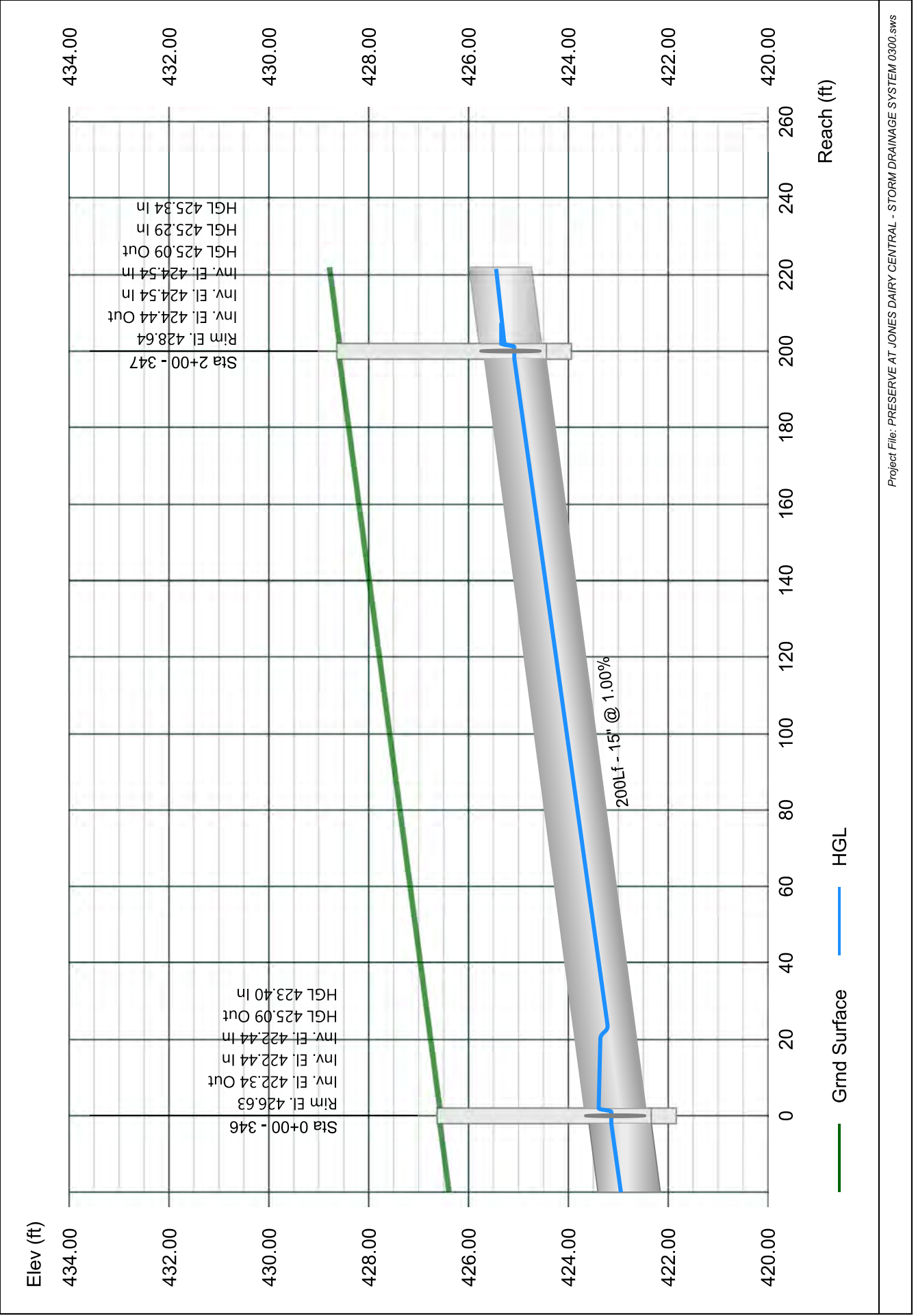

Line 39 - 348 TO 347

Stormwater Studio 2023 v 3.0.0.31

Project Name: Enter Project Name...

05-03-2023

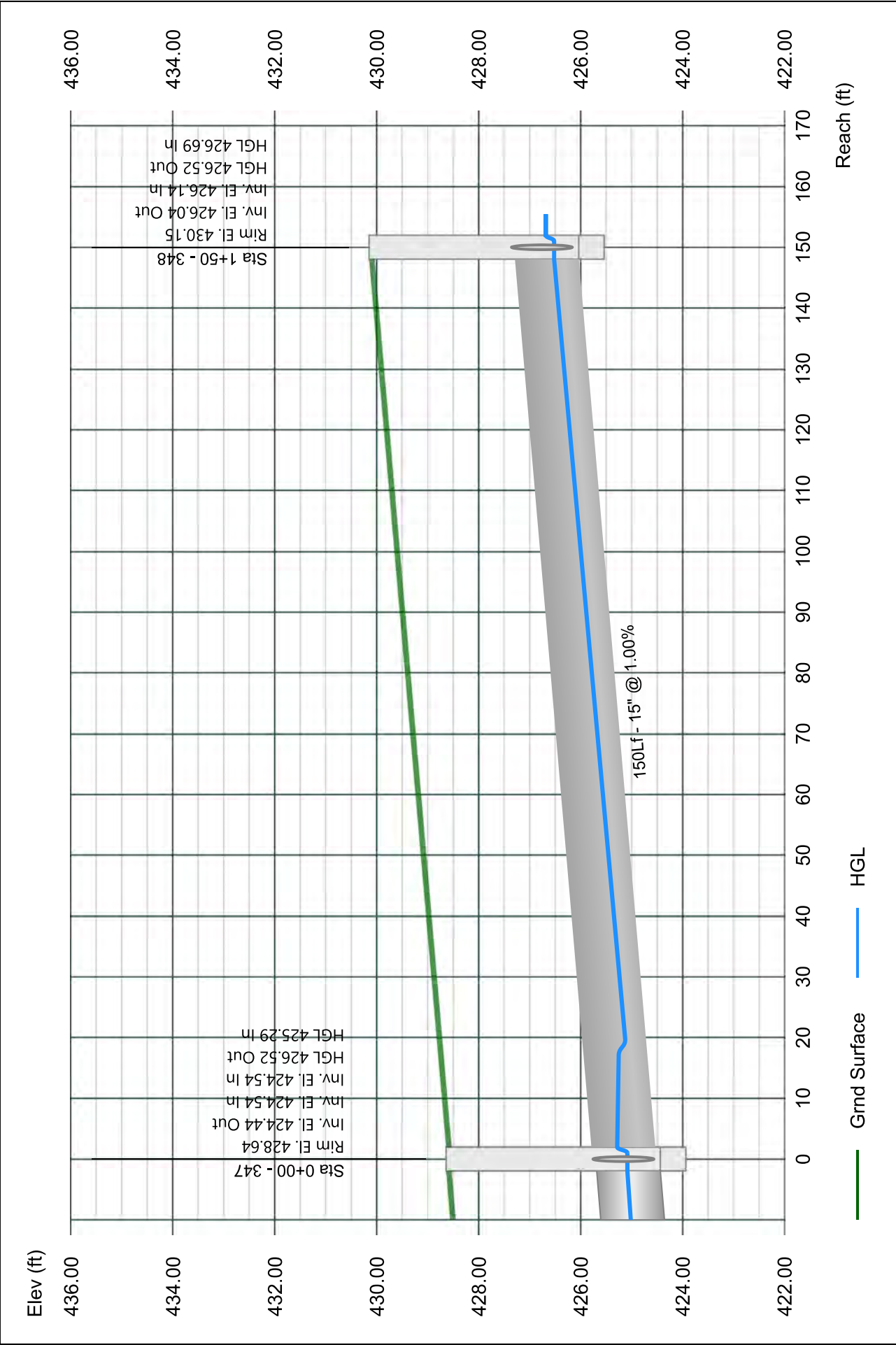

Line 40 - 348 TO 349

Stormwater Studio 2023 v 3.0.0.31

Project Name: Enter Project Name...

05-03-2023

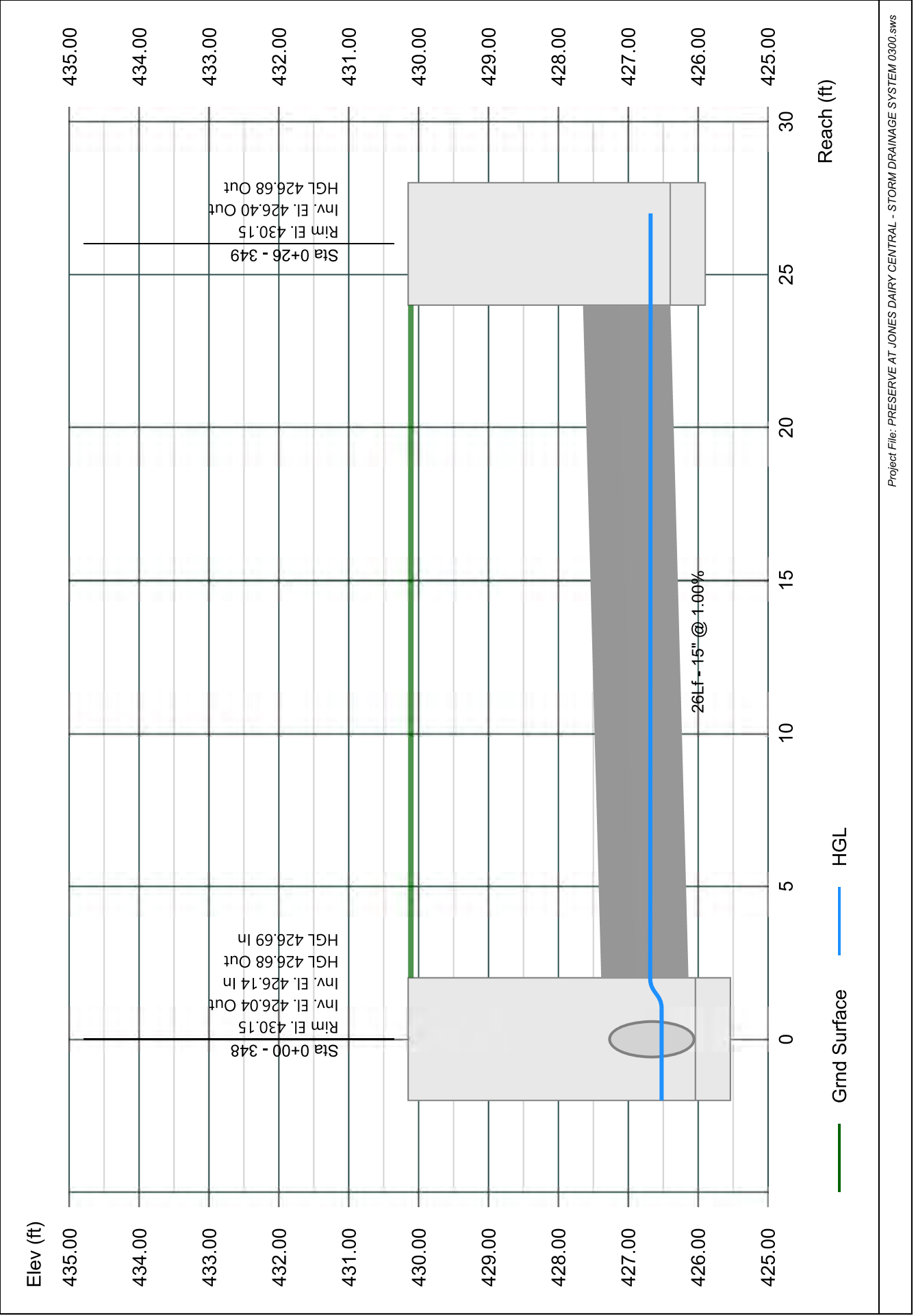

Line 41 - 354 TO 347

Stormwater Studio 2023 v 3.0.0.31

Project Name: Enter Project Name...

05-03-2023

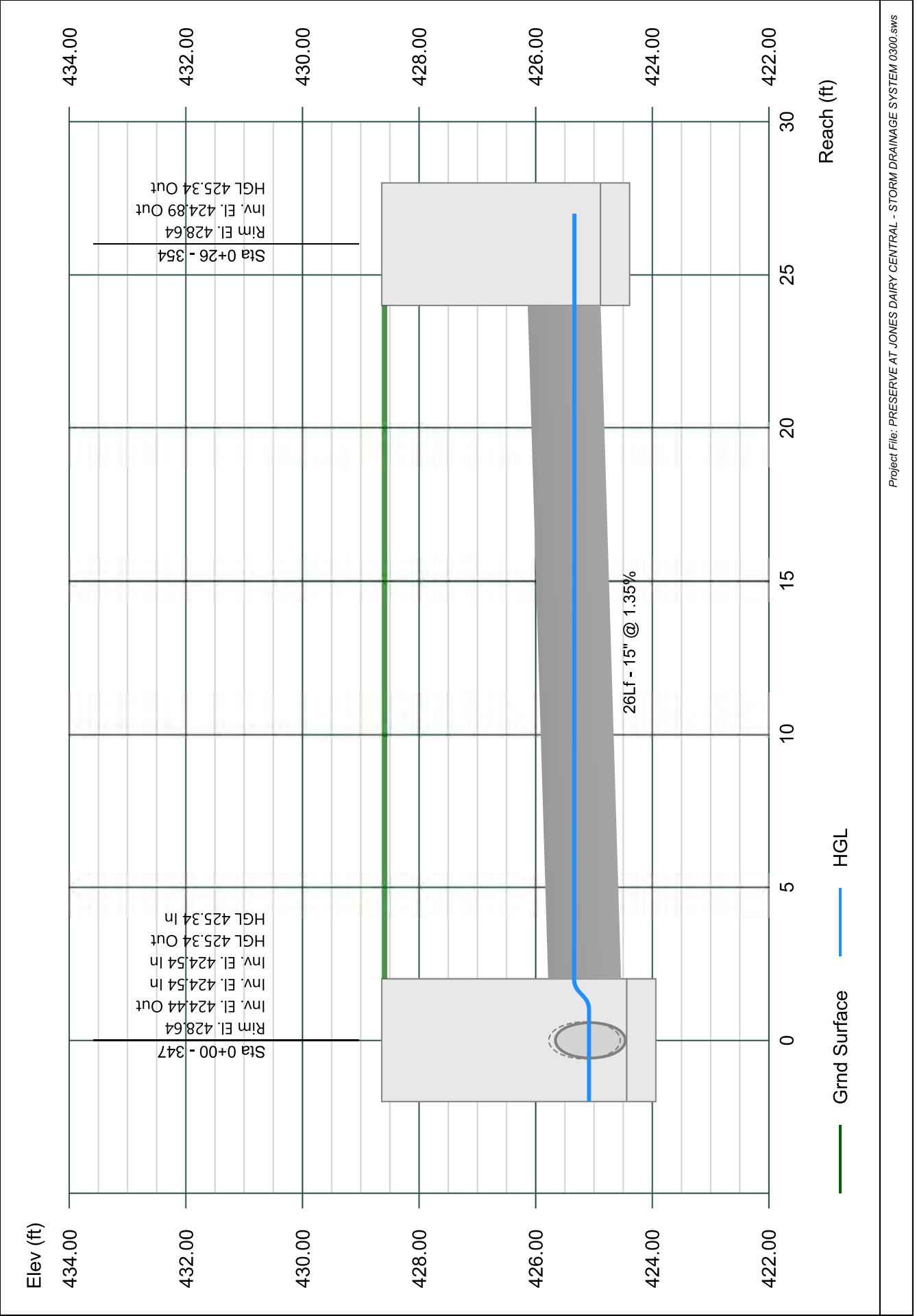

Line 42 - 353 TO 346

Stormwater Studio 2023 v 3.0.0.31

Project Name: Enter Project Name...

05-03-2023

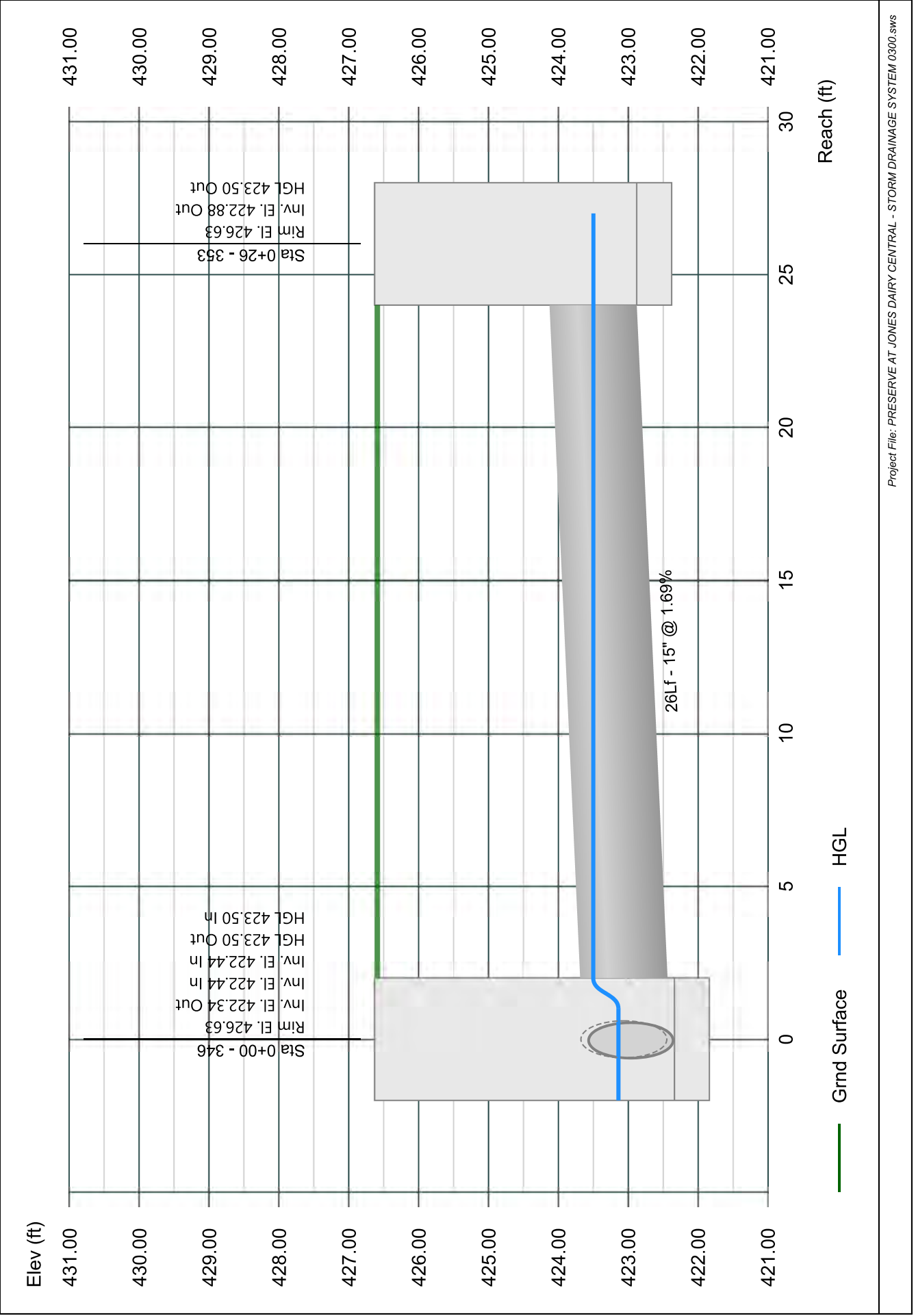

Line 43 - 351 TO 344

Stormwater Studio 2023 v 3.0.0.31

Project Name: Enter Project Name...

05-03-2023

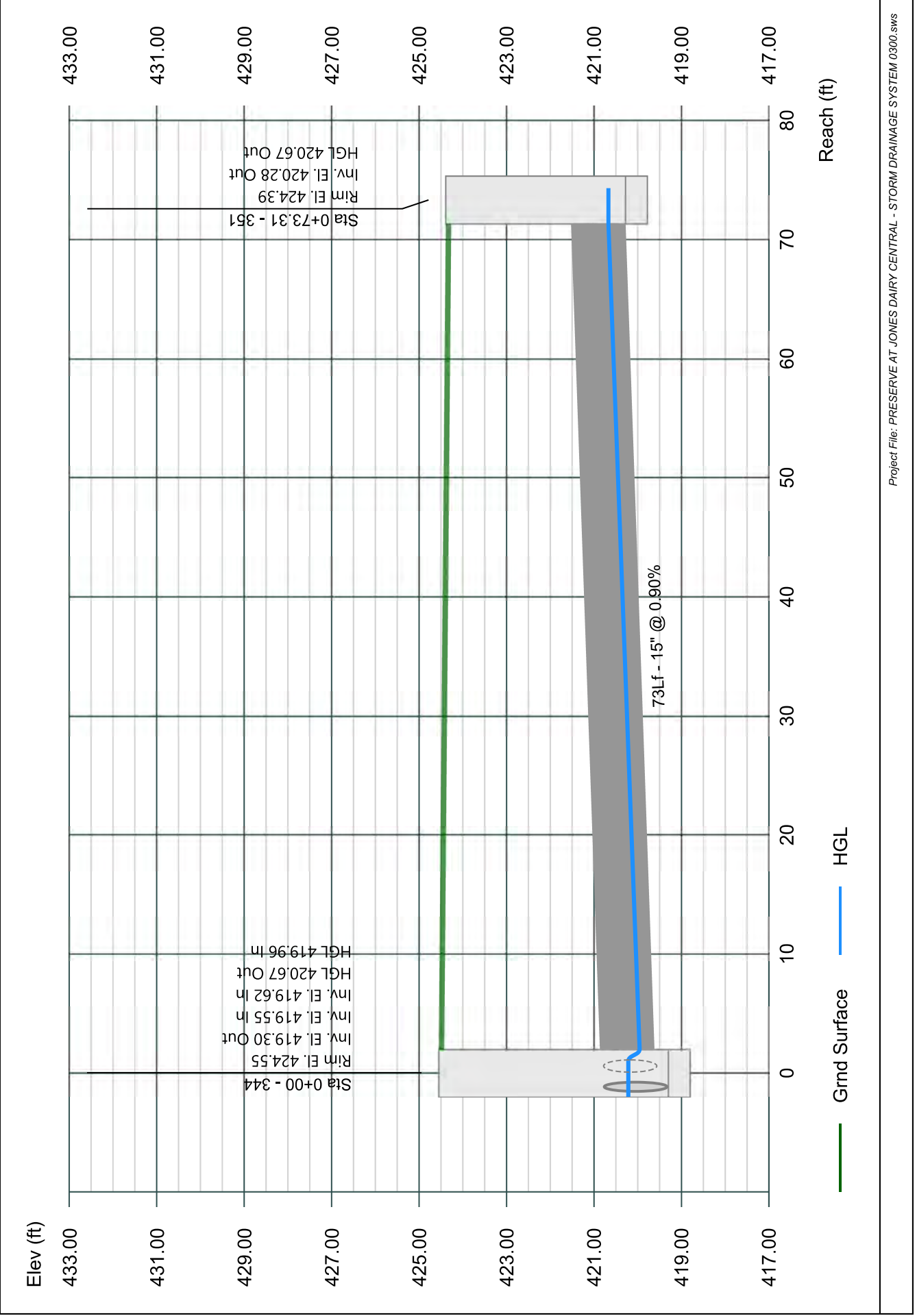

Line 44 - 315 TO 343A

Stormwater Studio 2023 v 3.0.0.31

Project Name: Enter Project Name...

05-03-2023

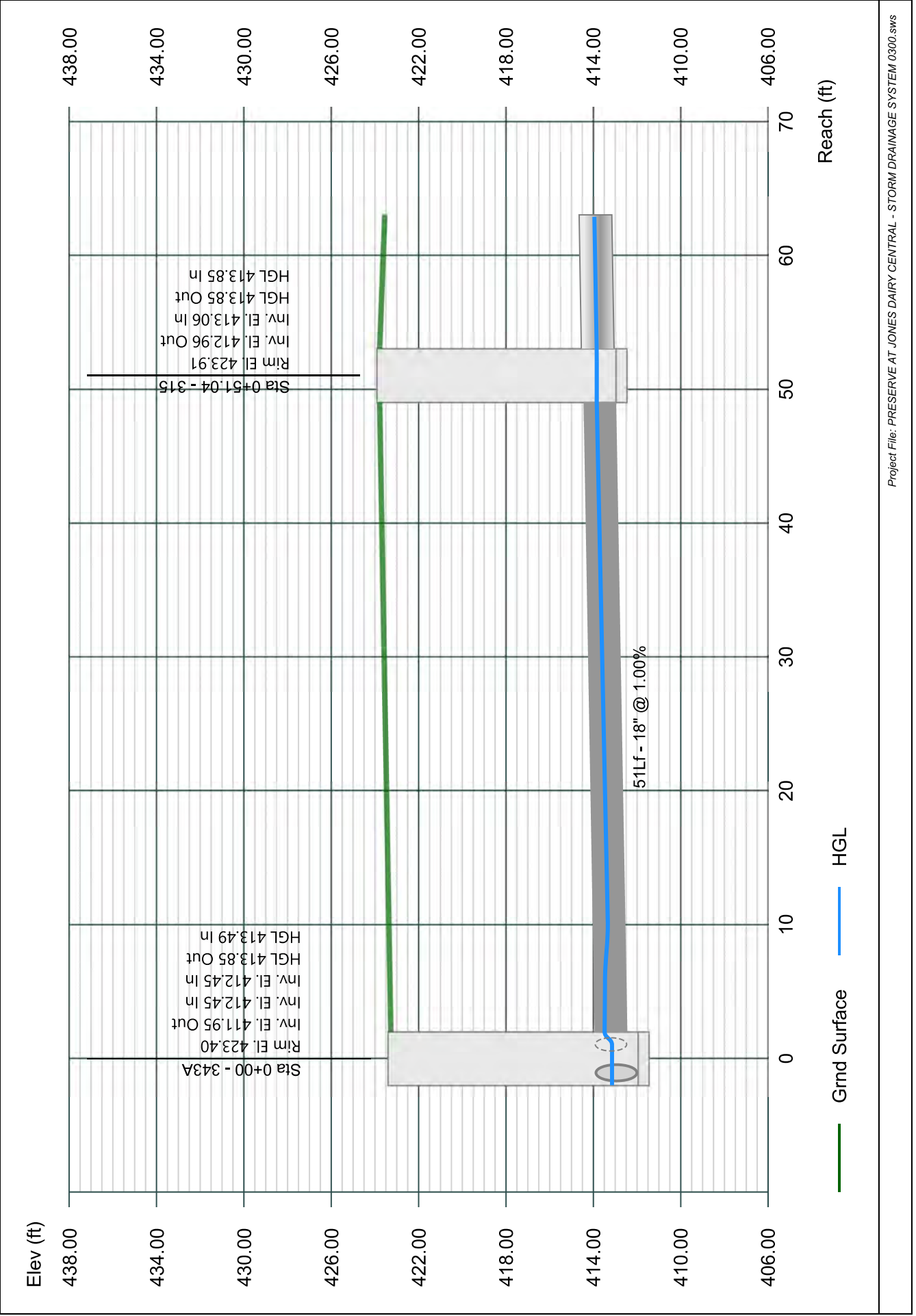

Line 45 - 316 TO 315

Stormwater Studio 2023 v 3.0.0.31

Project Name: Enter Project Name...

05-03-2023

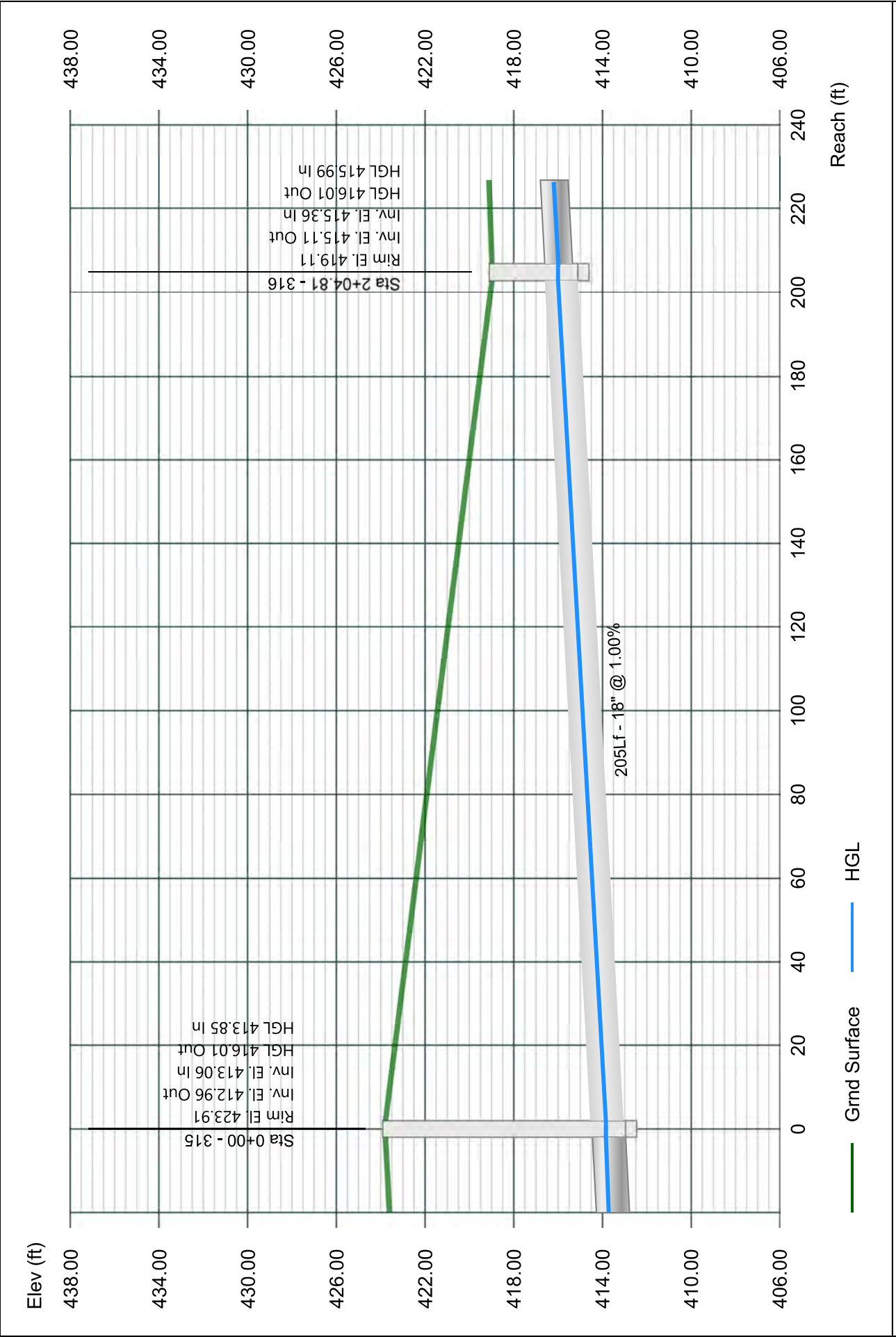

Line 46 - 317 TO 316

Stormwater Studio 2023 v 3.0.0.31

Project Name: Enter Project Name...

05-03-2023

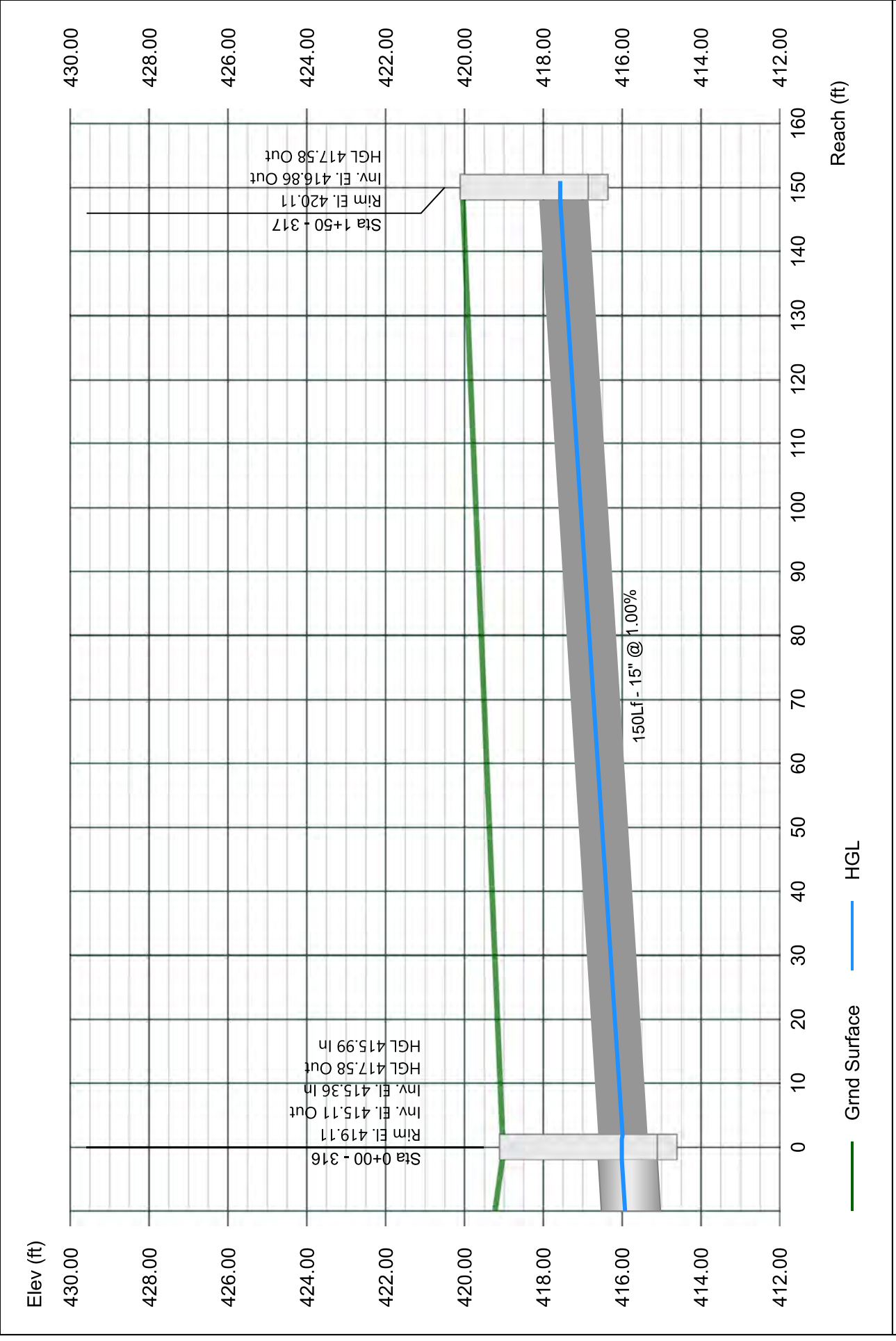

Line 47 - 350 TO 340

Stormwater Studio 2023 v 3.0.0.31

Project Name: Enter Project Name...

05-03-2023

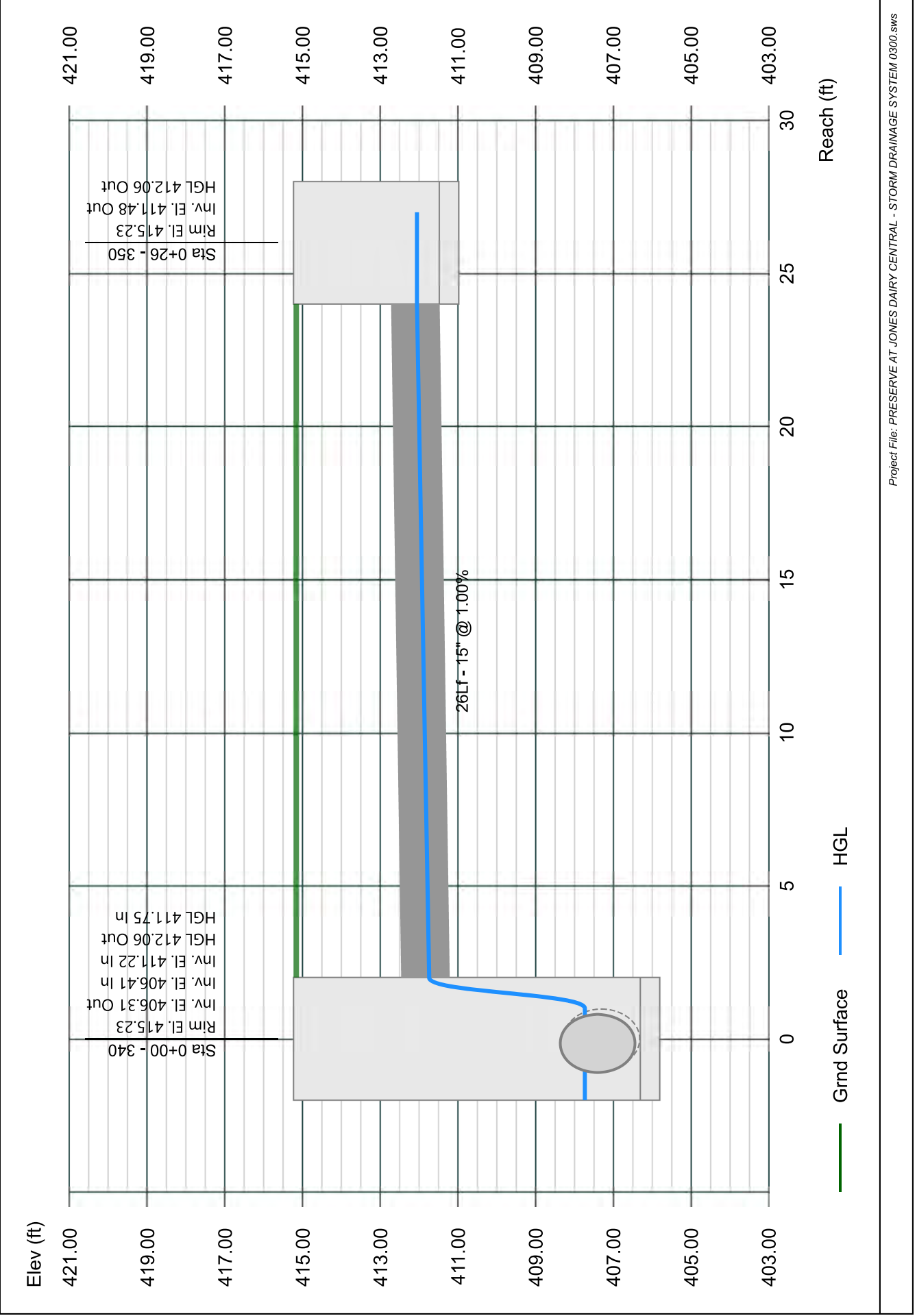

Line 48 - 333 TO 303

Stormwater Studio 2023 v 3.0.0.31

Project Name: Enter Project Name...

05-03-2023

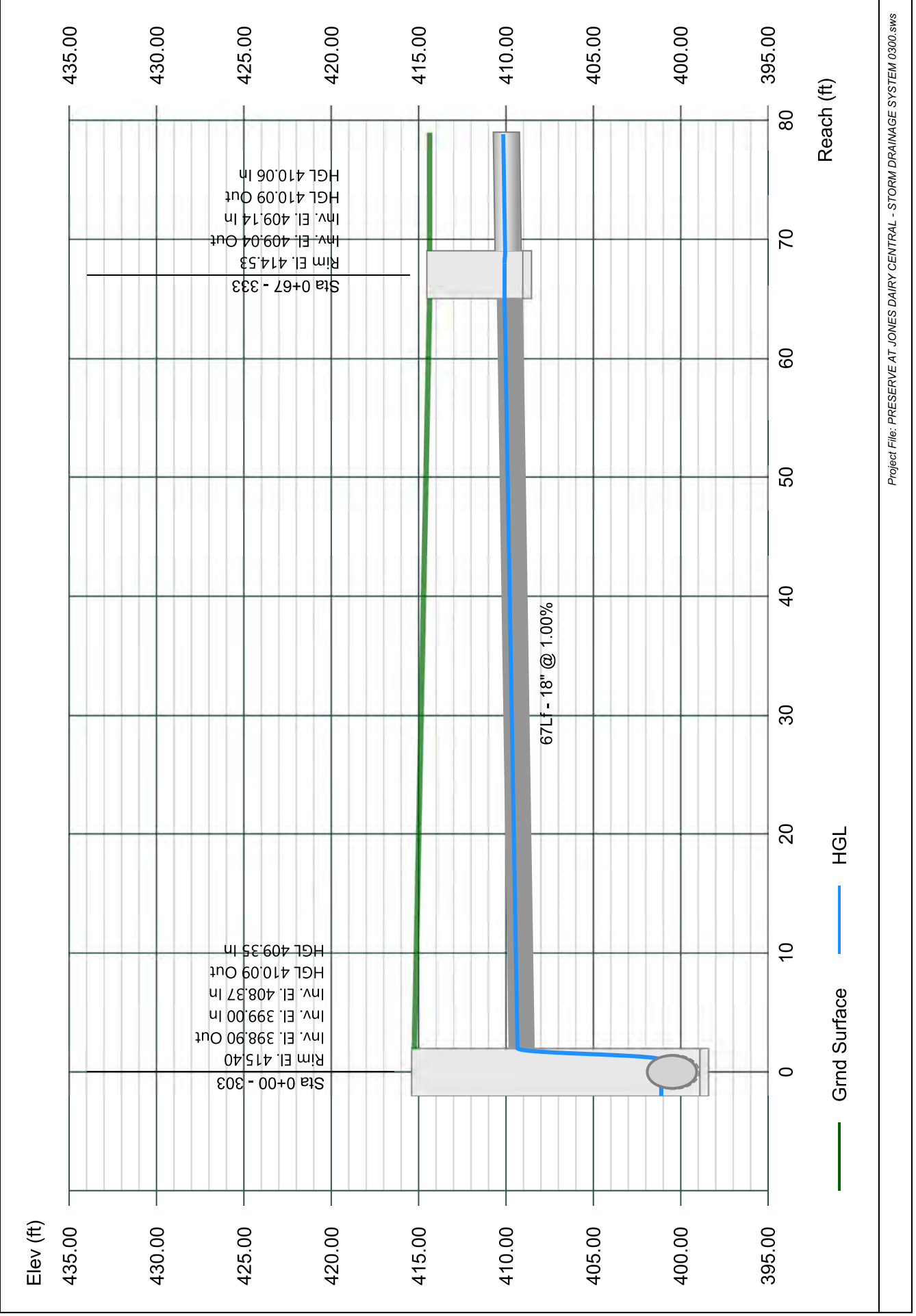

Line 49 - 334 TO 333

Stormwater Studio 2023 v 3.0.0.31

Project Name: Enter Project Name...

05-03-2023

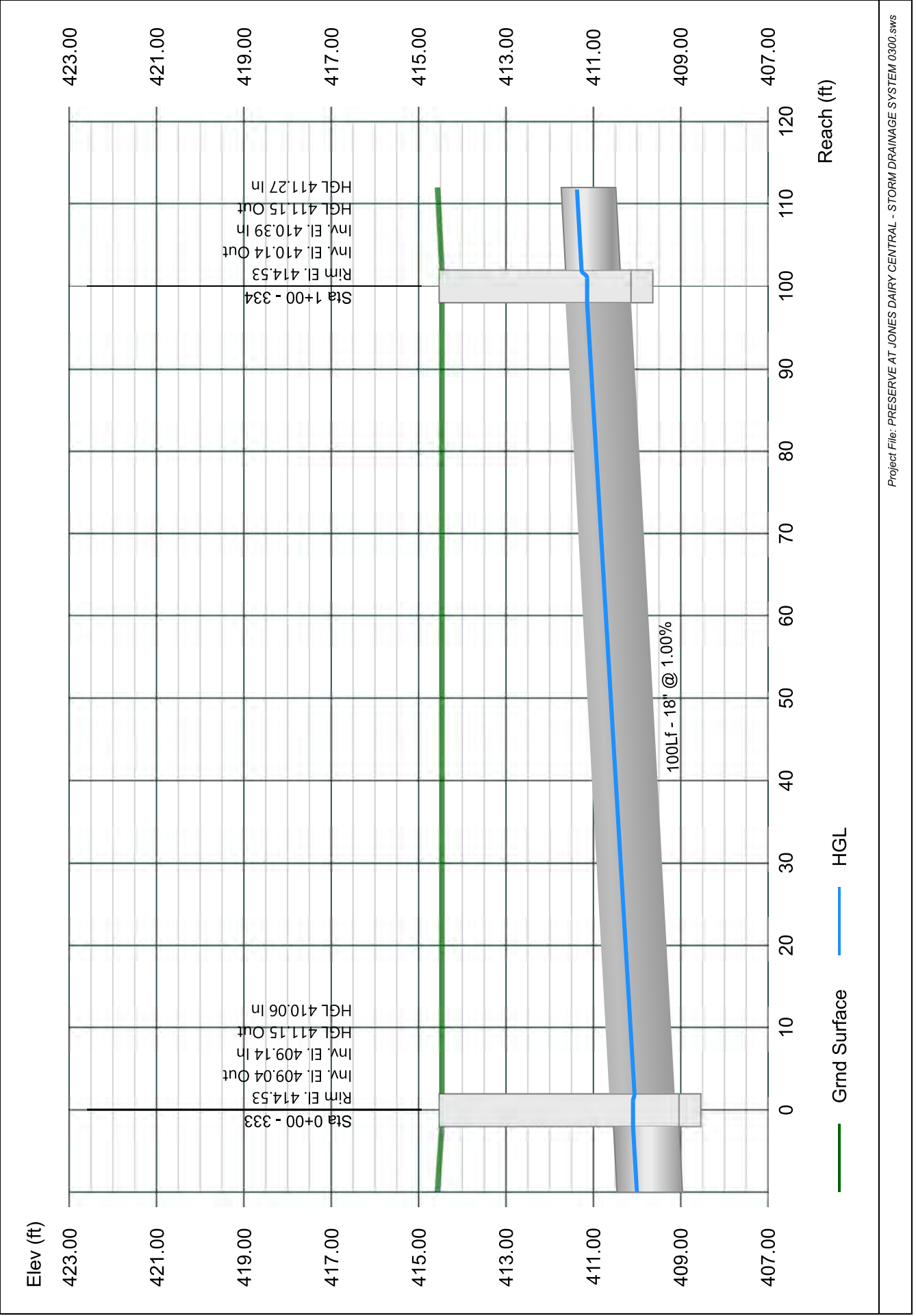

Line 50 - 335 TO 334

Stormwater Studio 2023 v 3.0.0.31

Project Name: Enter Project Name...

05-03-2023

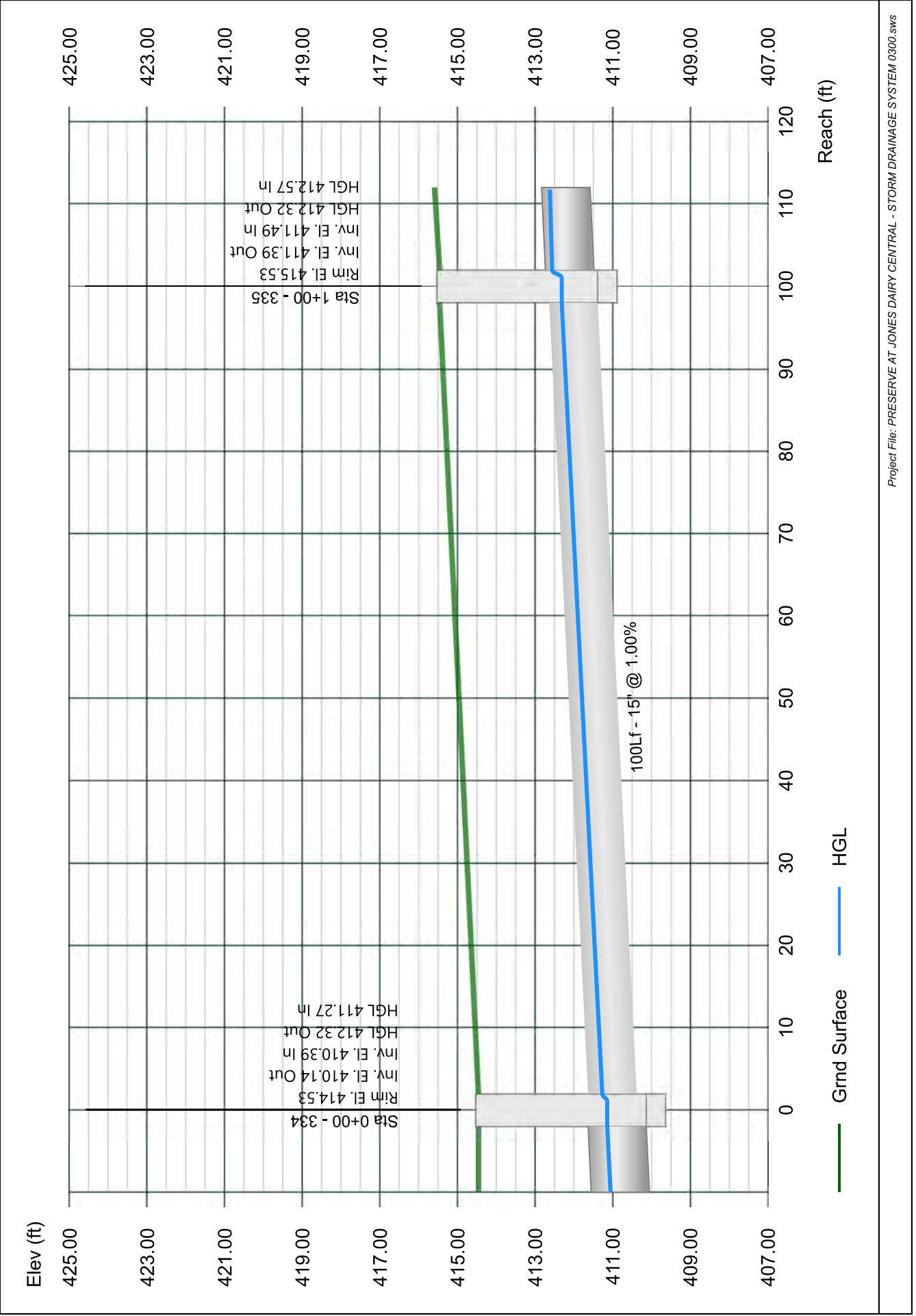

Line 51 - 336 TO 335

Stormwater Studio 2023 v 3.0.0.31

Project Name: Enter Project Name...

05-03-2023

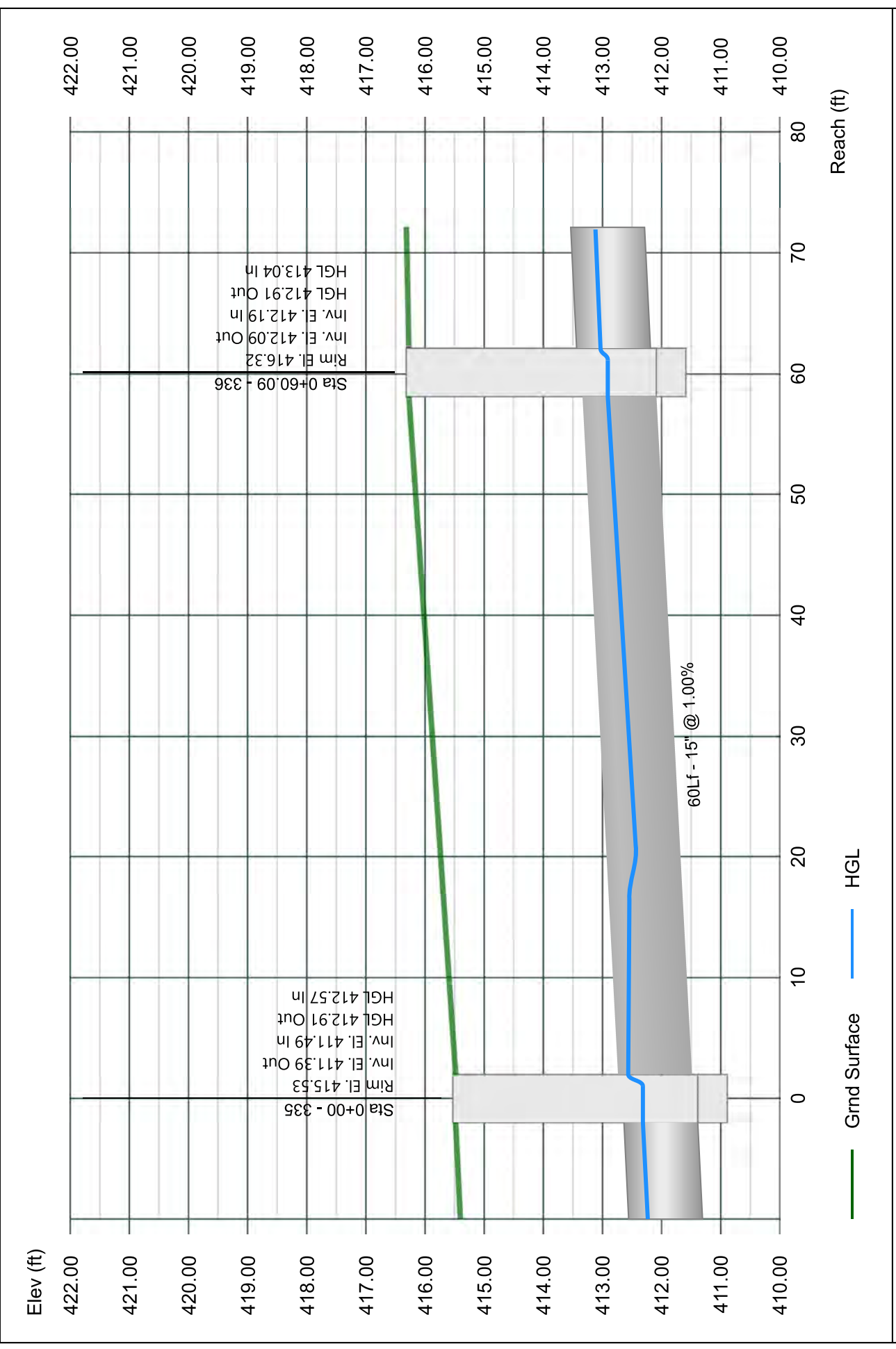

Line 52 - 337 TO 336

Stormwater Studio 2023 v 3.0.0.31

Project Name: Enter Project Name...

05-03-2023

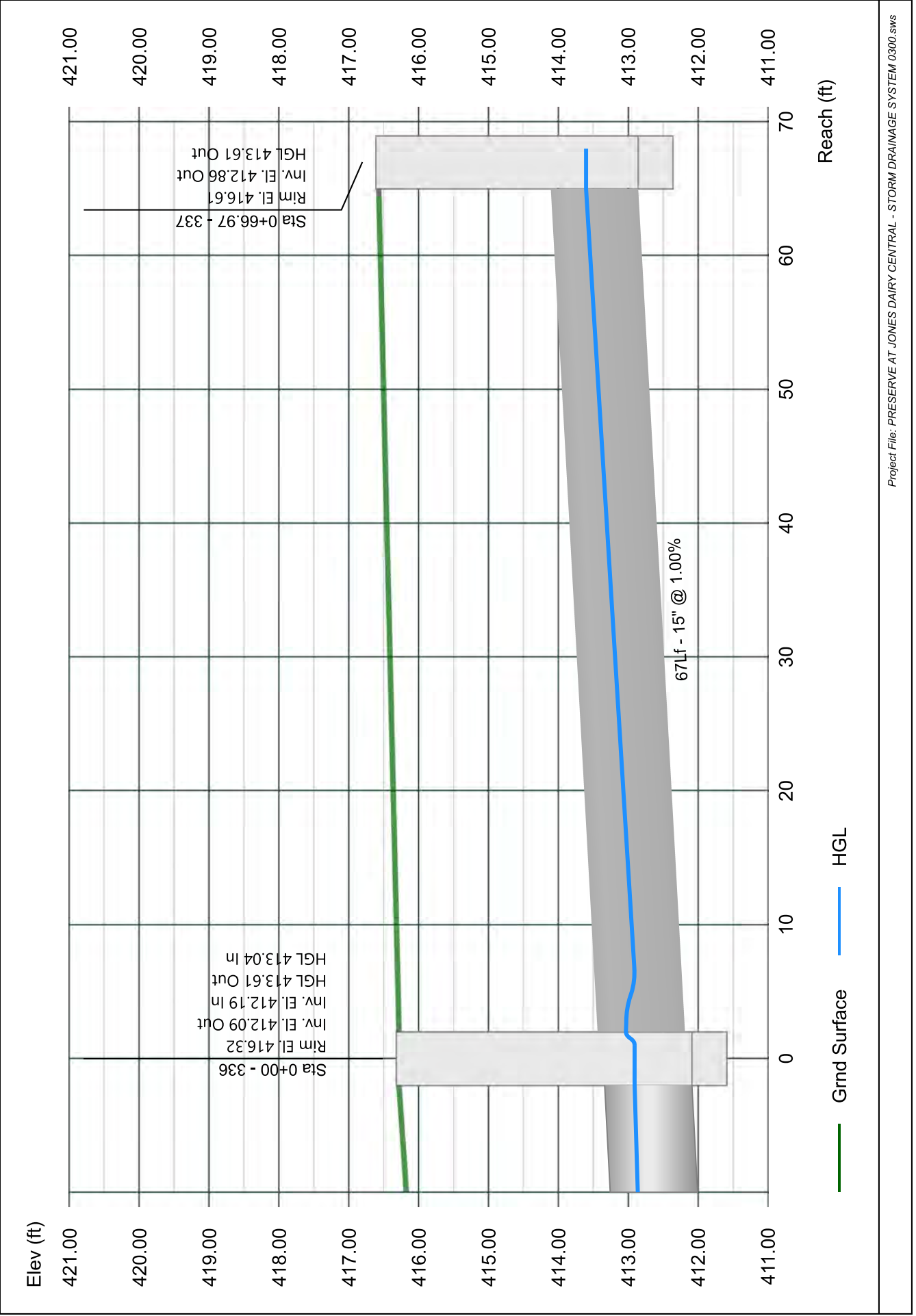

Line 53 - 322 TO 302

Stormwater Studio 2023 v 3.0.0.31

Project Name: Enter Project Name...

05-03-2023

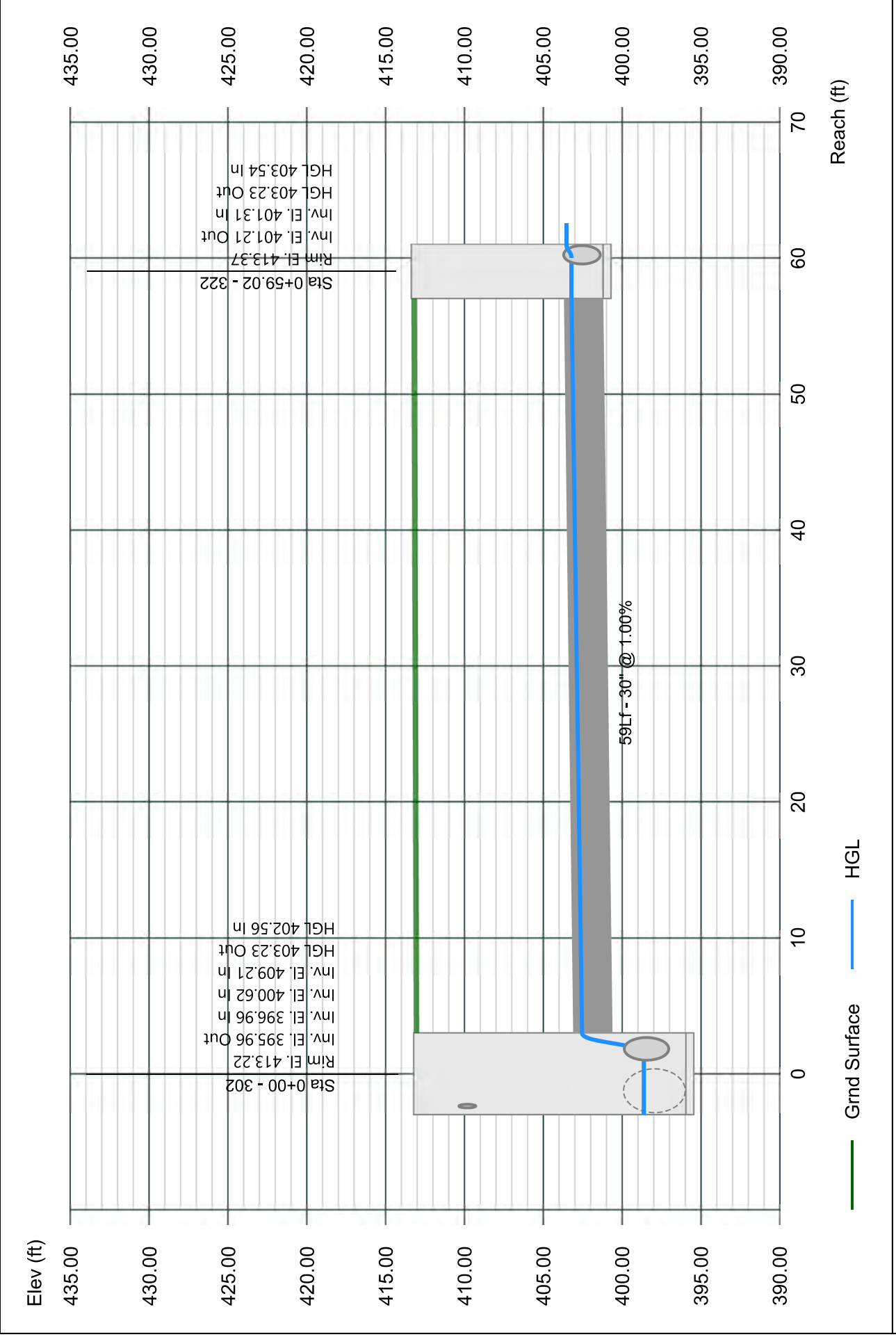

Line 54 - 323 TO 322

Stormwater Studio 2023 v 3.0.0.31

Project Name: Enter Project Name...

05-03-2023

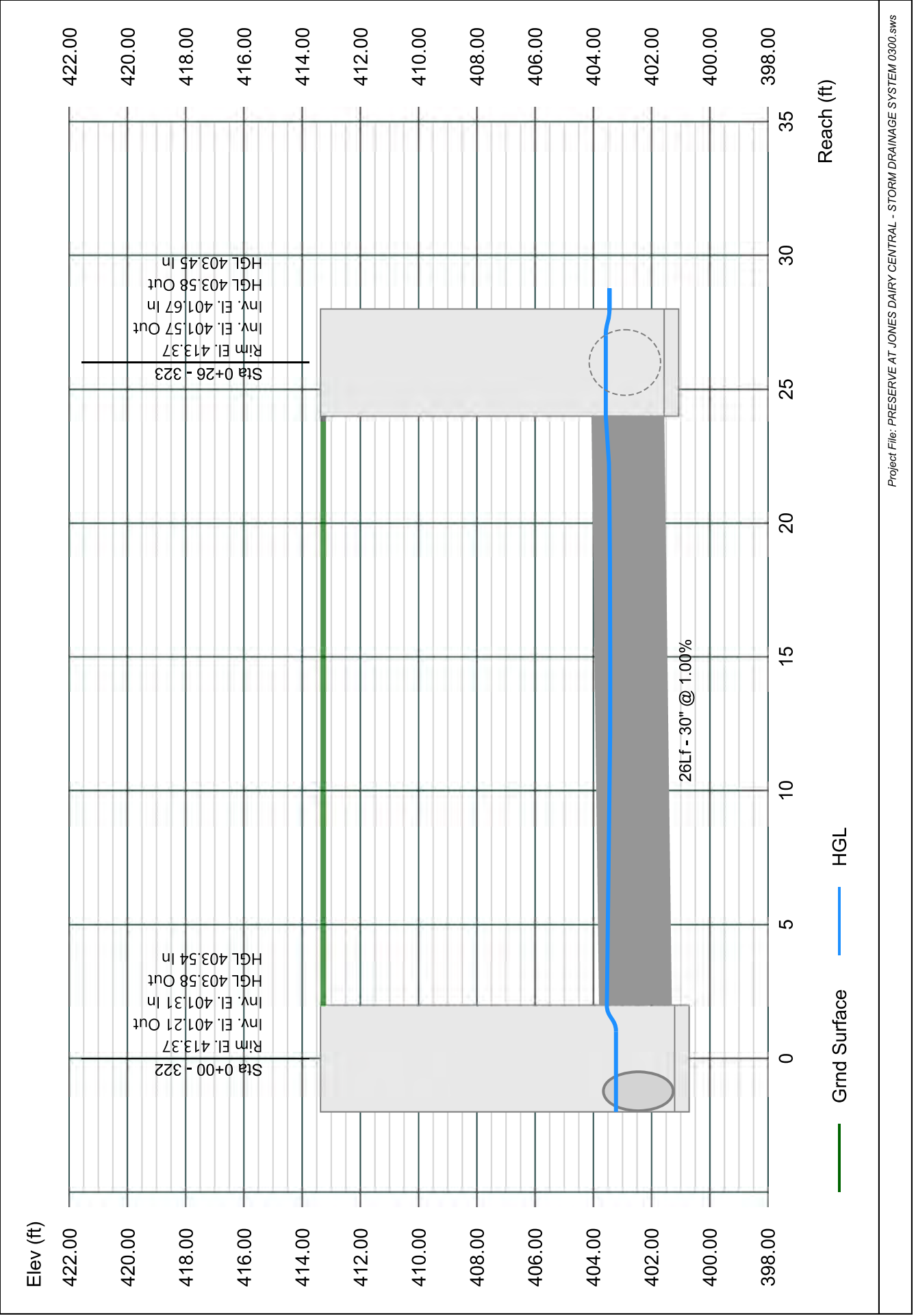

Line 55 - 324 TO 323

Stormwater Studio 2023 v 3.0.0.31

Project Name: Enter Project Name...

05-03-2023

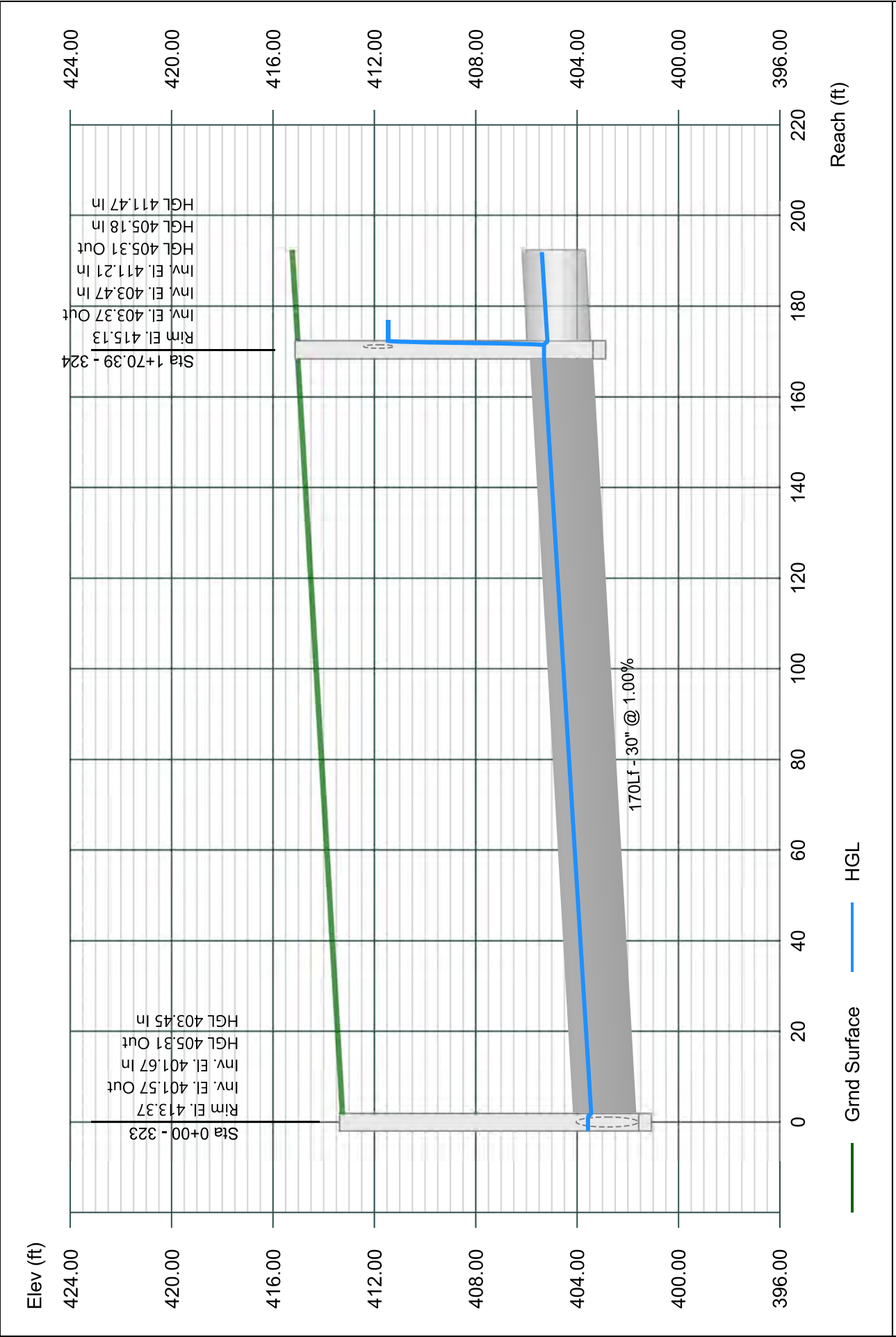

Line 56 - 325 TO 324

Stormwater Studio 2023 v 3.0.0.31

Project Name: Enter Project Name...

05-03-2023

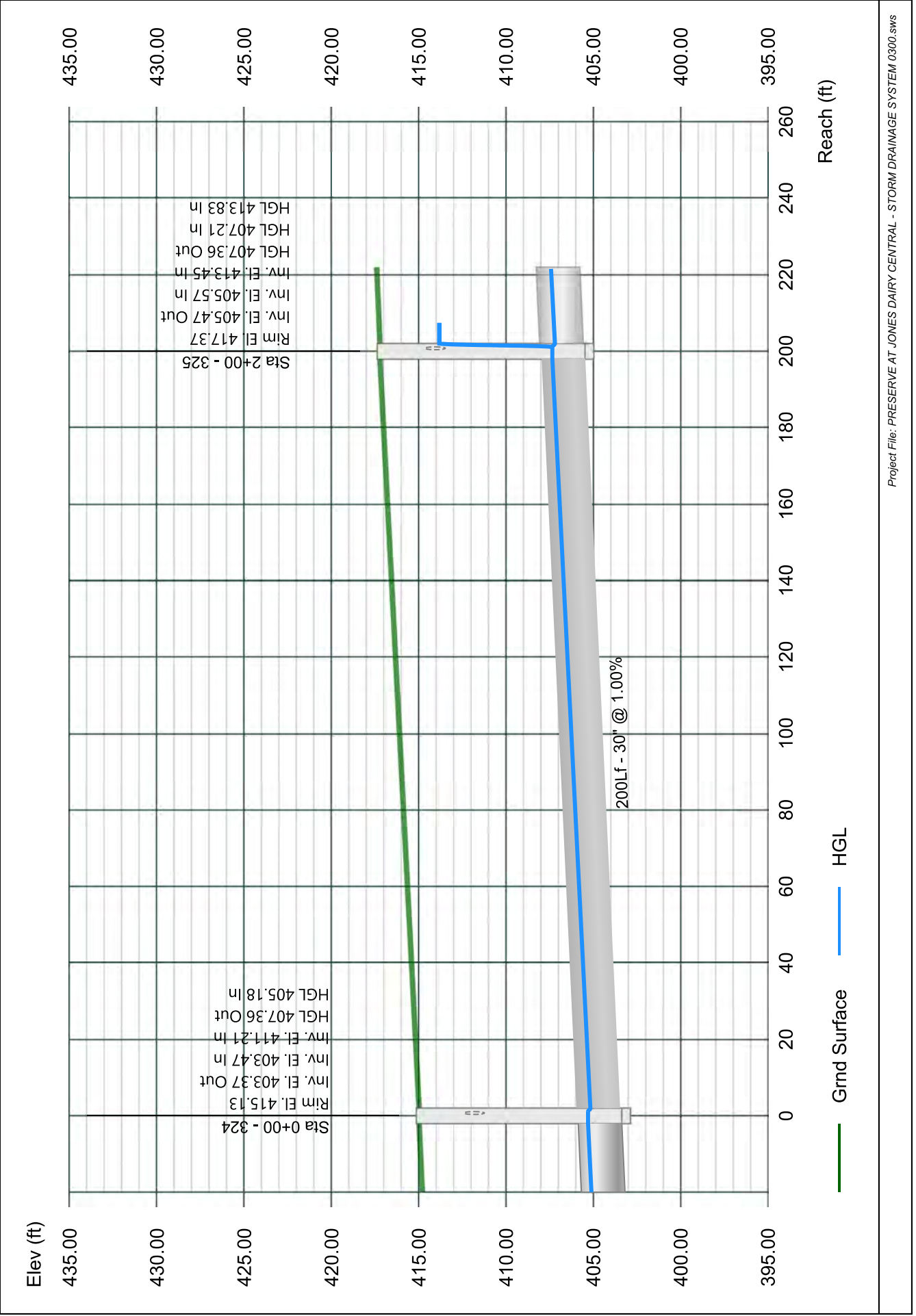

Line 57 - 326 TO 325

Stormwater Studio 2023 v 3.0.0.31

Project Name: Enter Project Name...

05-03-2023

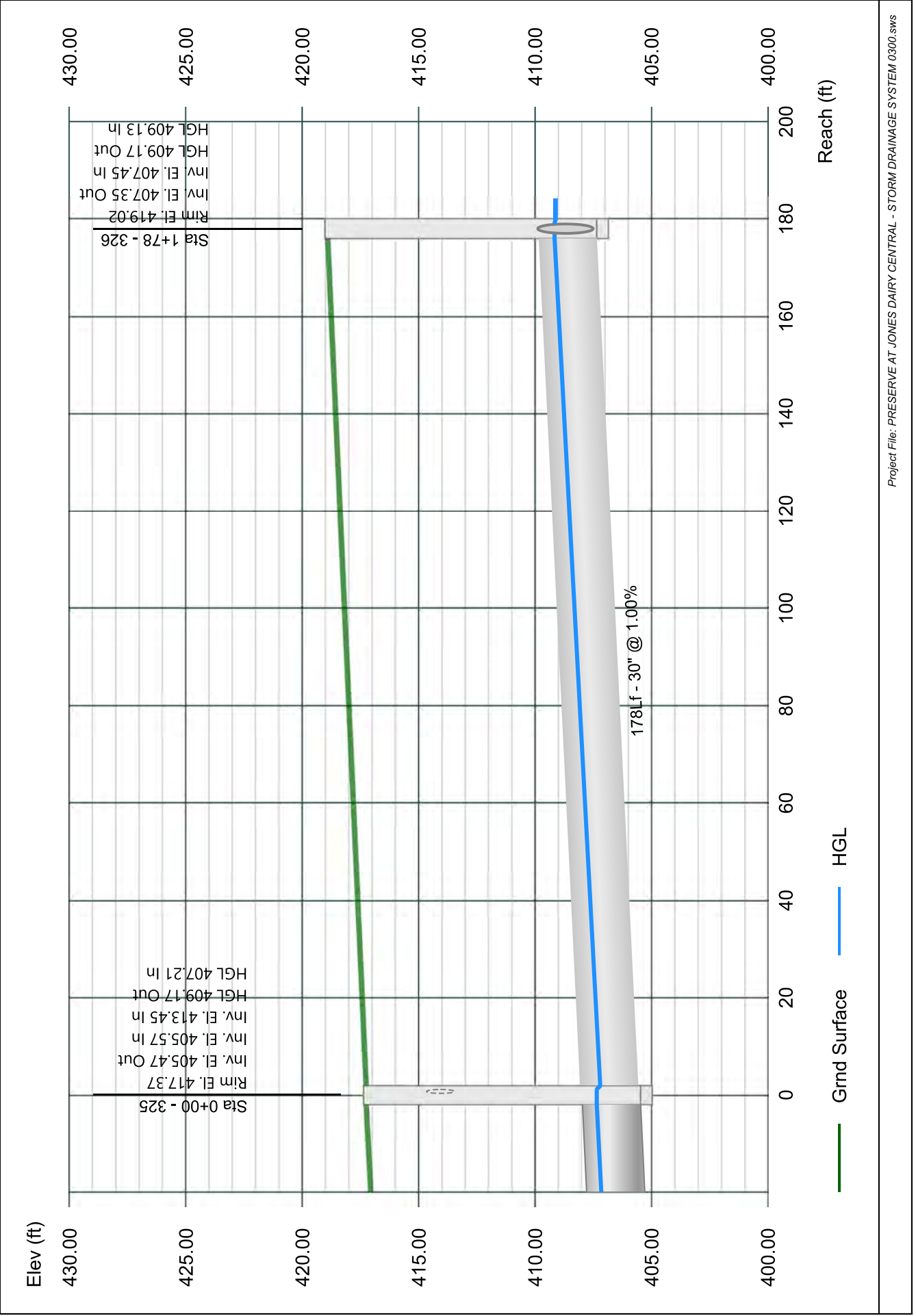

Line 58 - 326 TO 327

Stormwater Studio 2023 v 3.0.0.31

Project Name: Enter Project Name...

05-03-2023

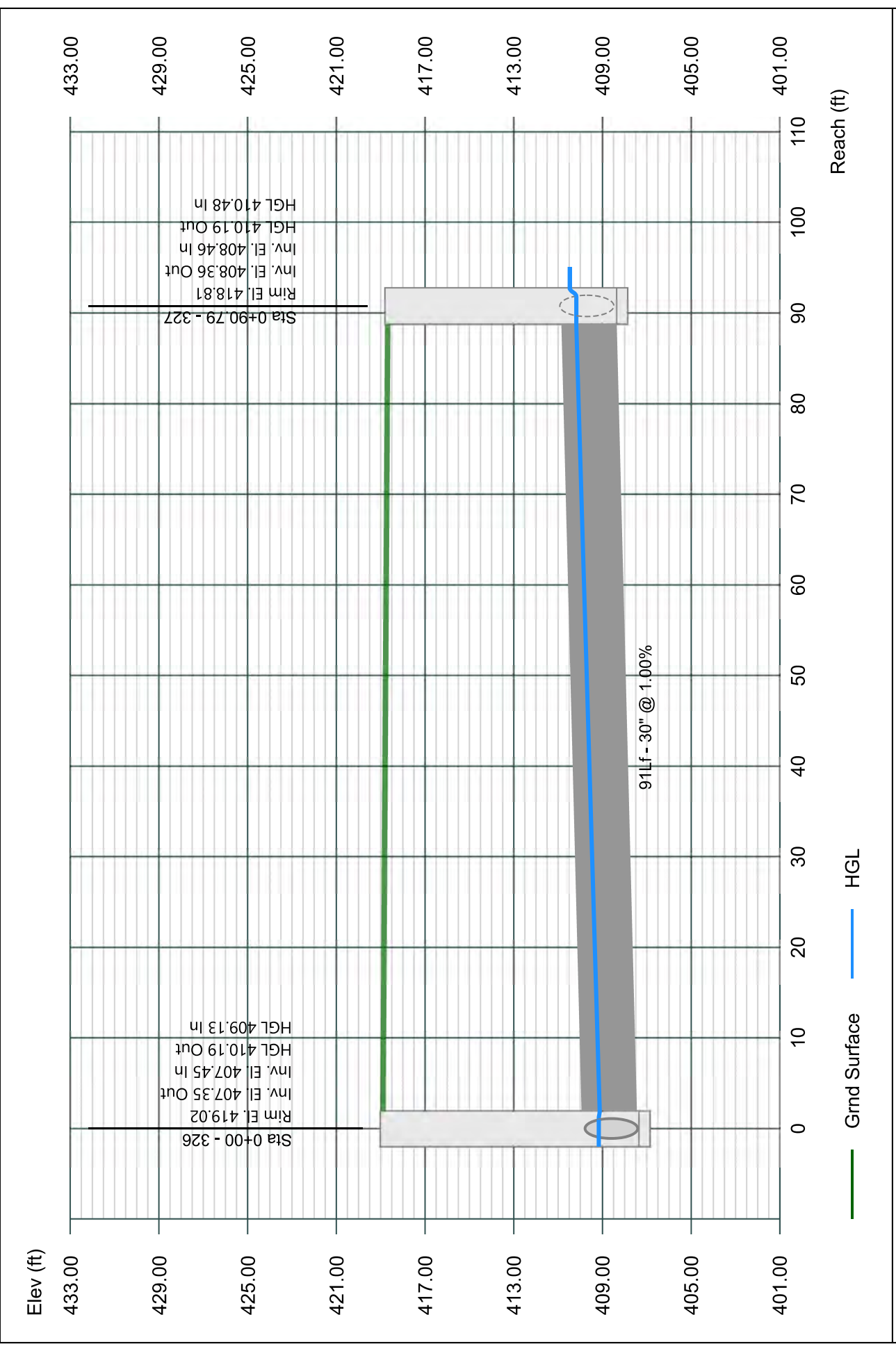

Line 59 - 328 TO 327

Stormwater Studio 2023 v 3.0.0.31

Project Name: Enter Project Name...

05-03-2023

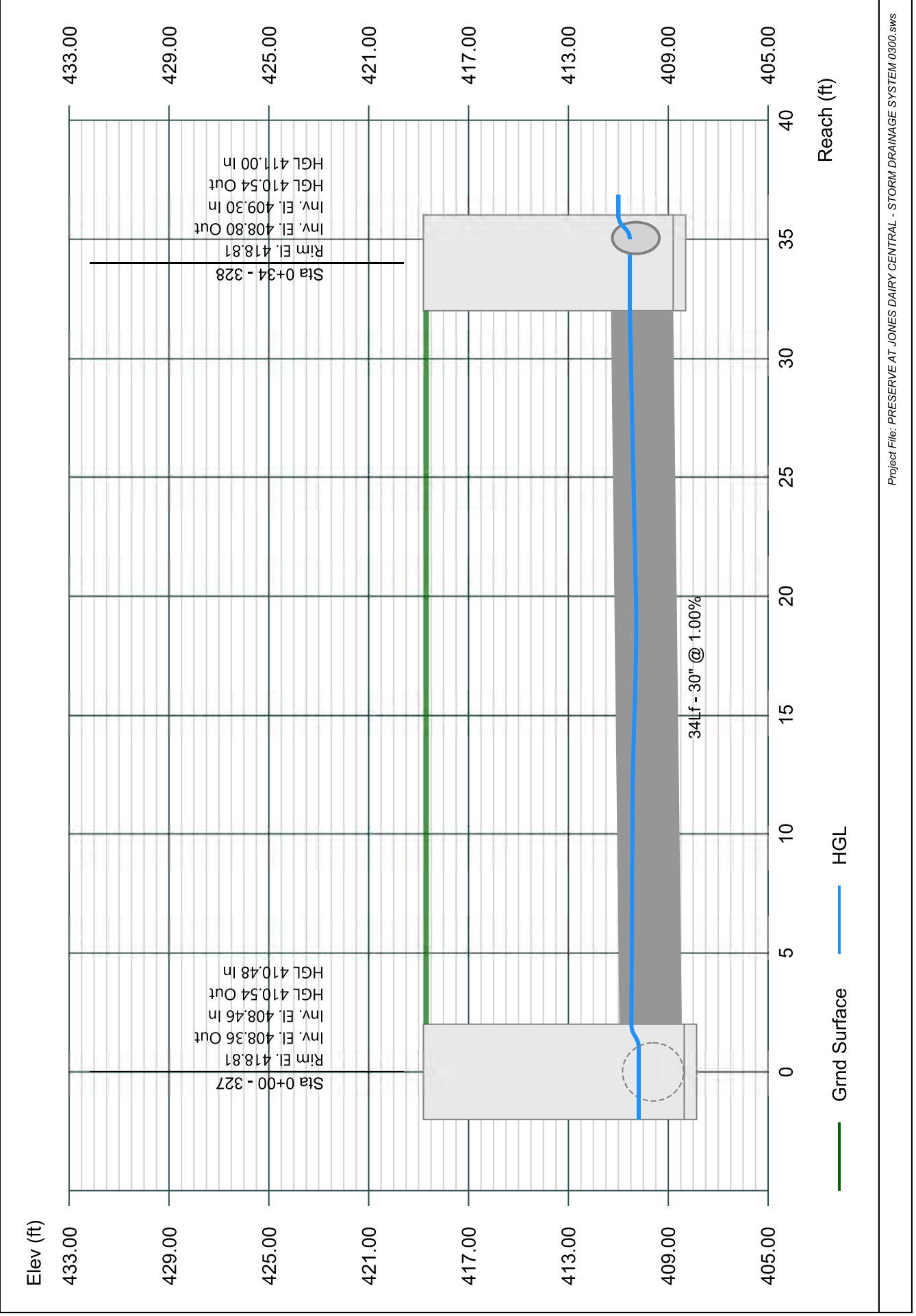

Line 60 - 329 TO 328

Stormwater Studio 2023 v 3.0.0.31

Project Name: Enter Project Name...

05-03-2023

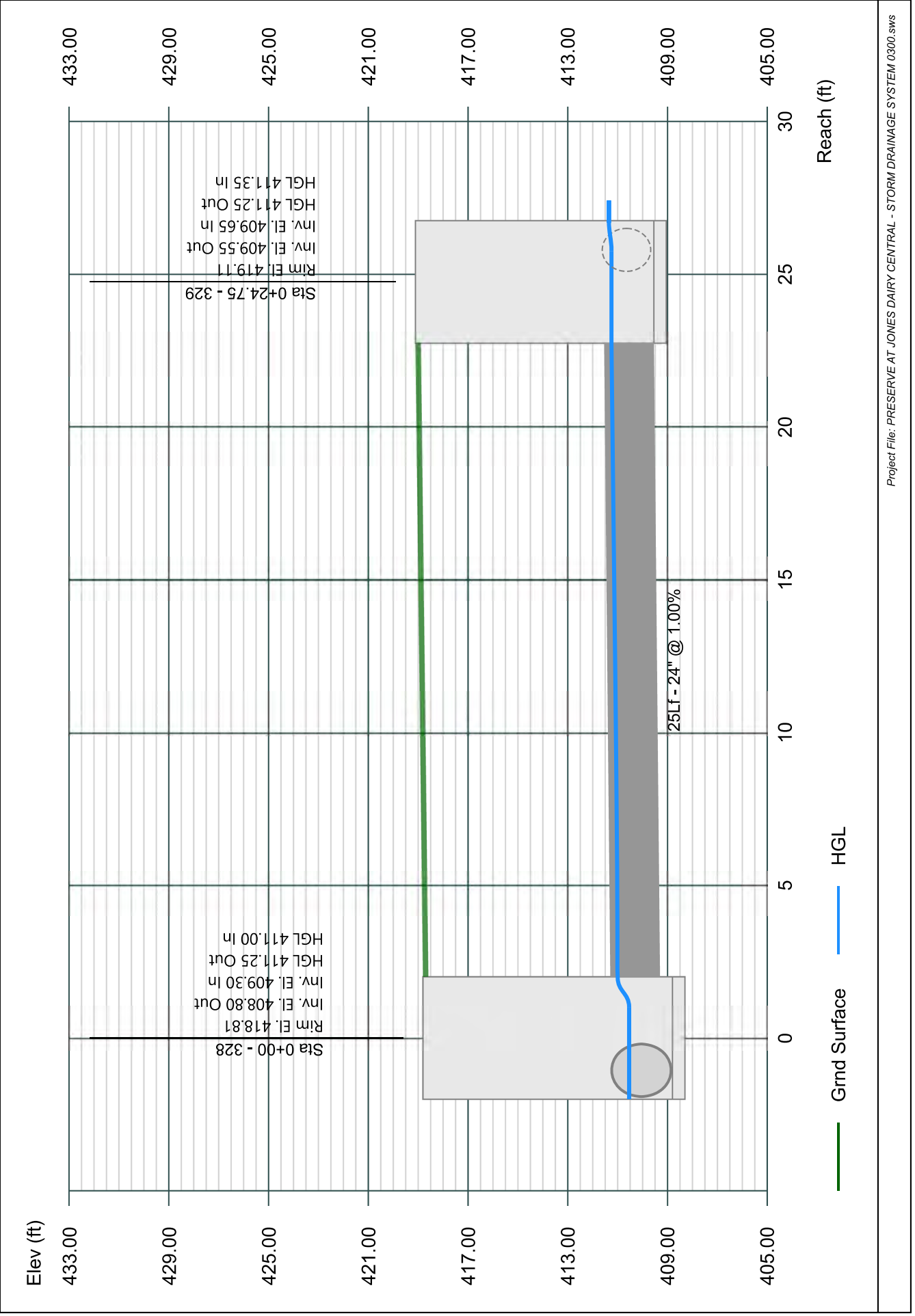

Line 61 - 330 TO 329

Stormwater Studio 2023 v 3.0.0.31

Project Name: Enter Project Name...

05-03-2023

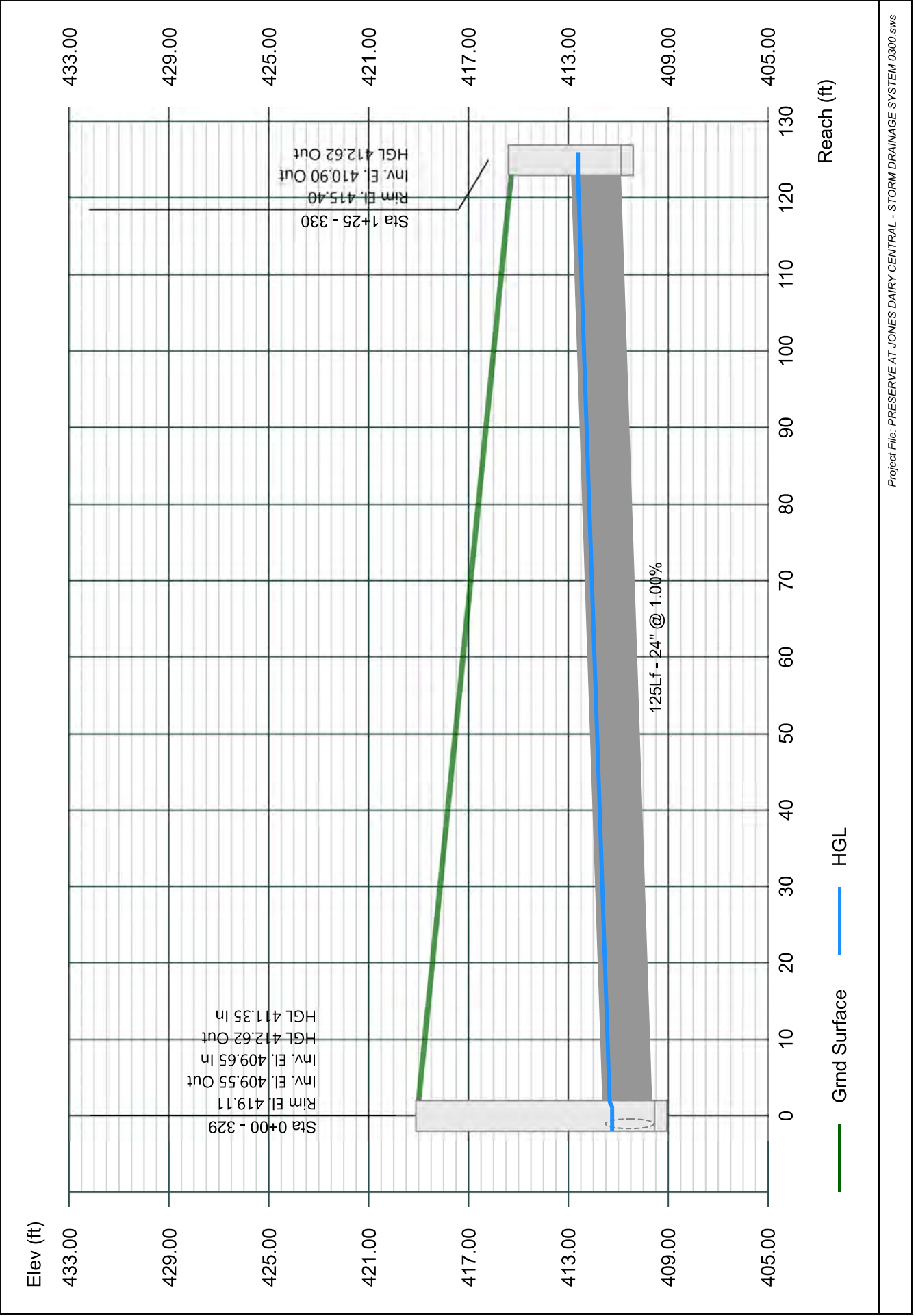

Line 62 - 332 TO 325

Stormwater Studio 2023 v 3.0.0.31

Project Name: Enter Project Name...

05-03-2023

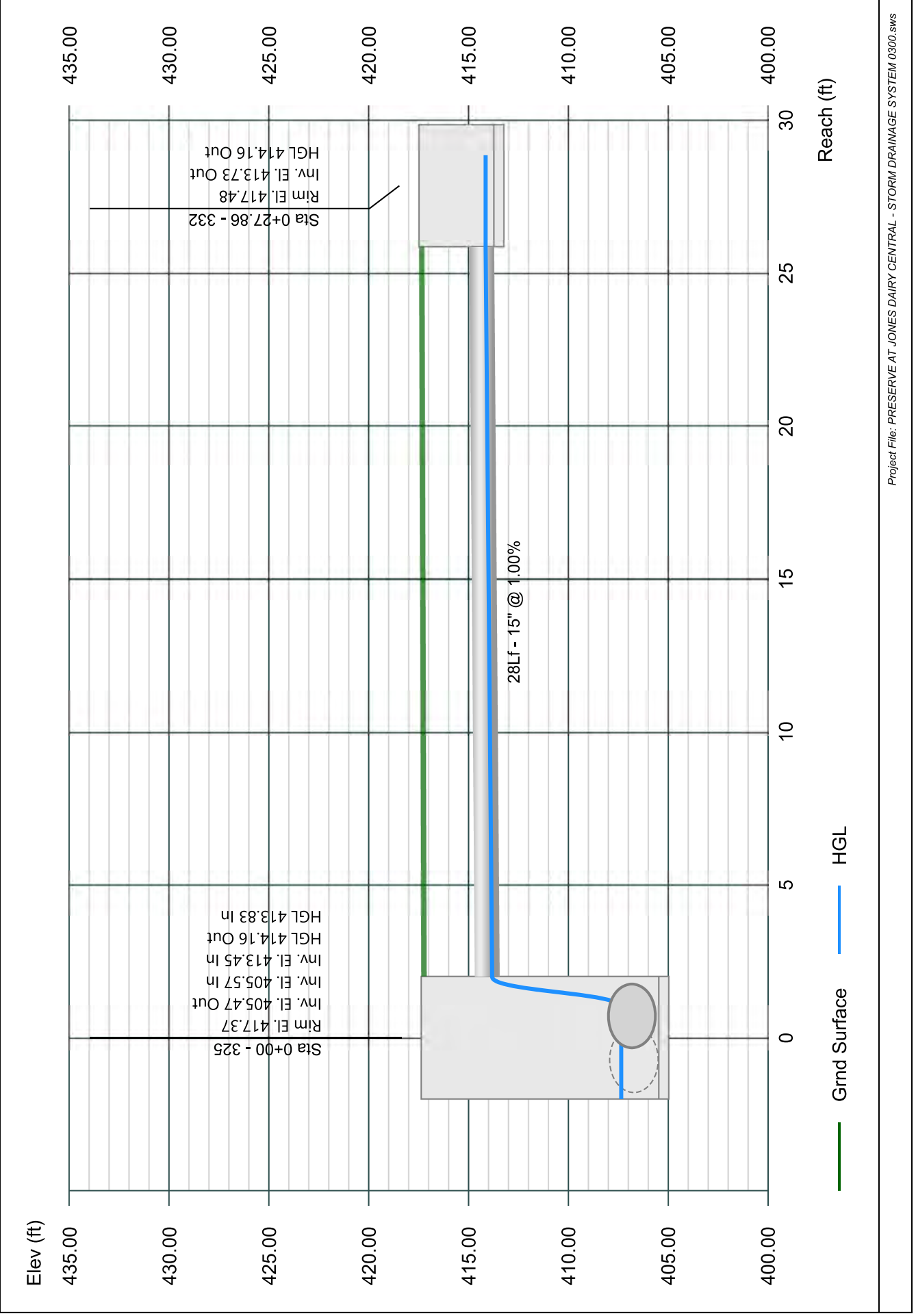

Line 63 - 331 TO 324

Stormwater Studio 2023 v 3.0.0.31

Project Name: Enter Project Name...

05-03-2023

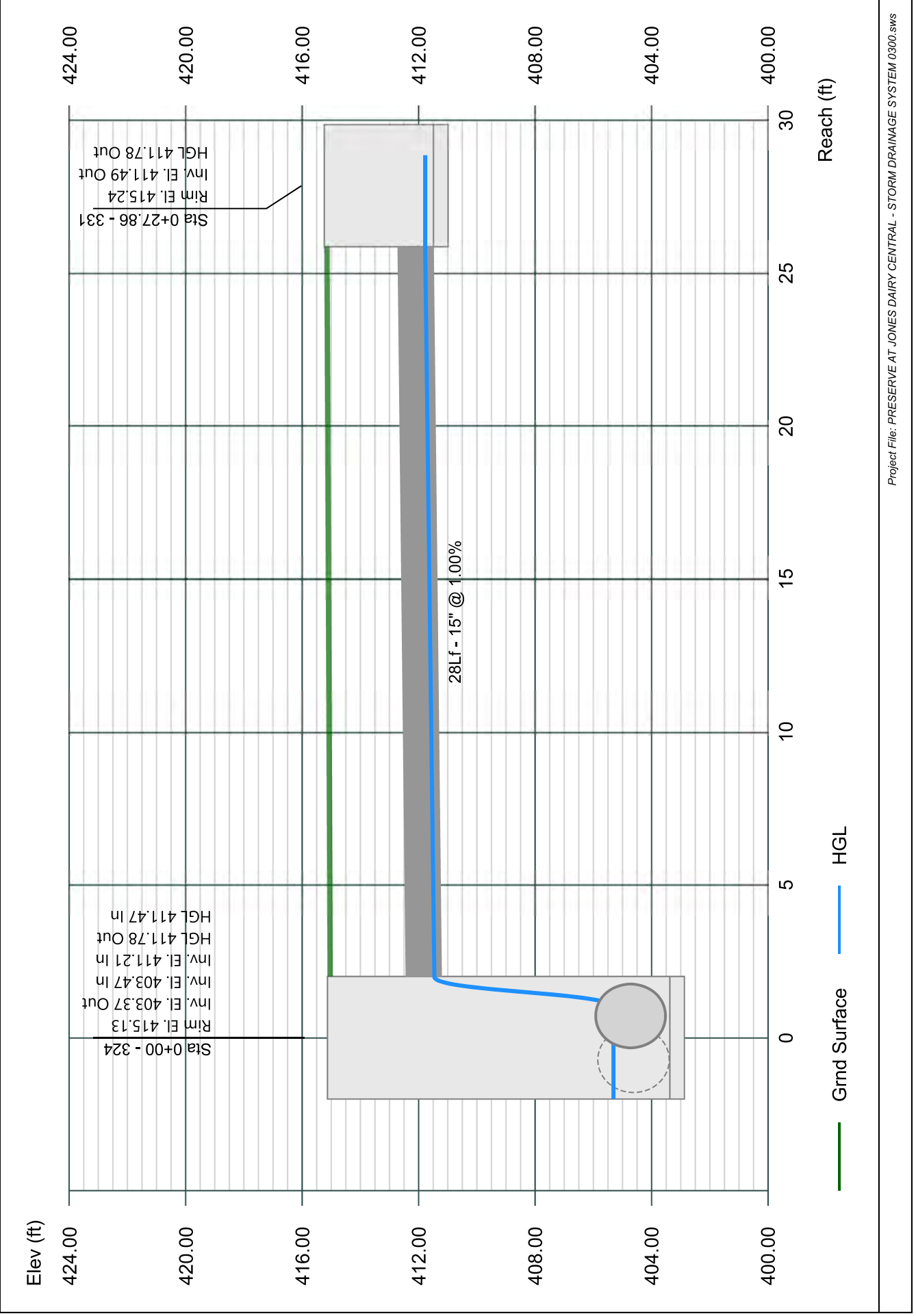

Line 64 - 321 TO 302

Stormwater Studio 2023 v 3.0.0.31

Project Name: Enter Project Name...

05-03-2023

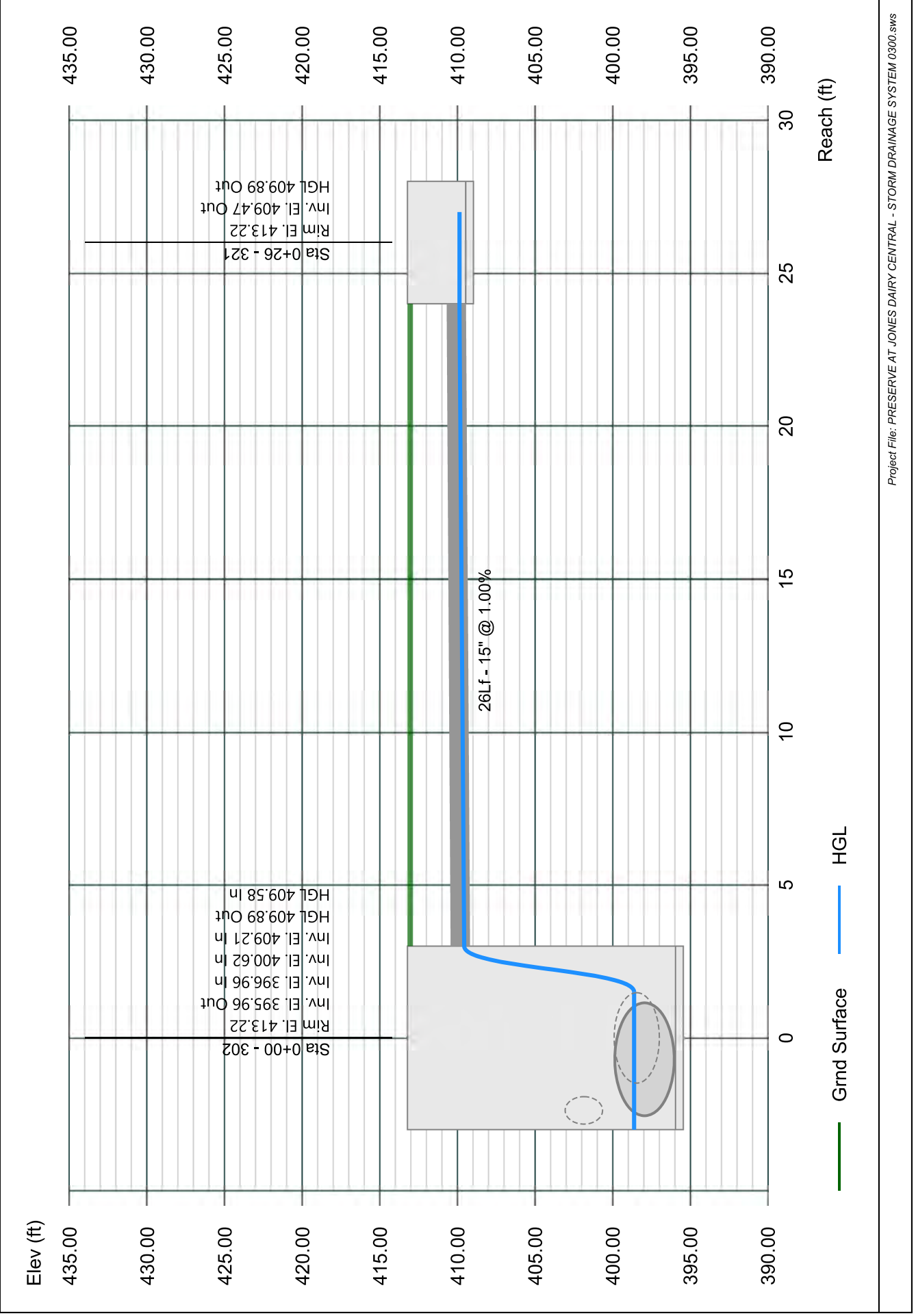

Line 65 - 366 TO 301

Stormwater Studio 2023 v 3.0.0.31

Project Name: Enter Project Name...

05-03-2023

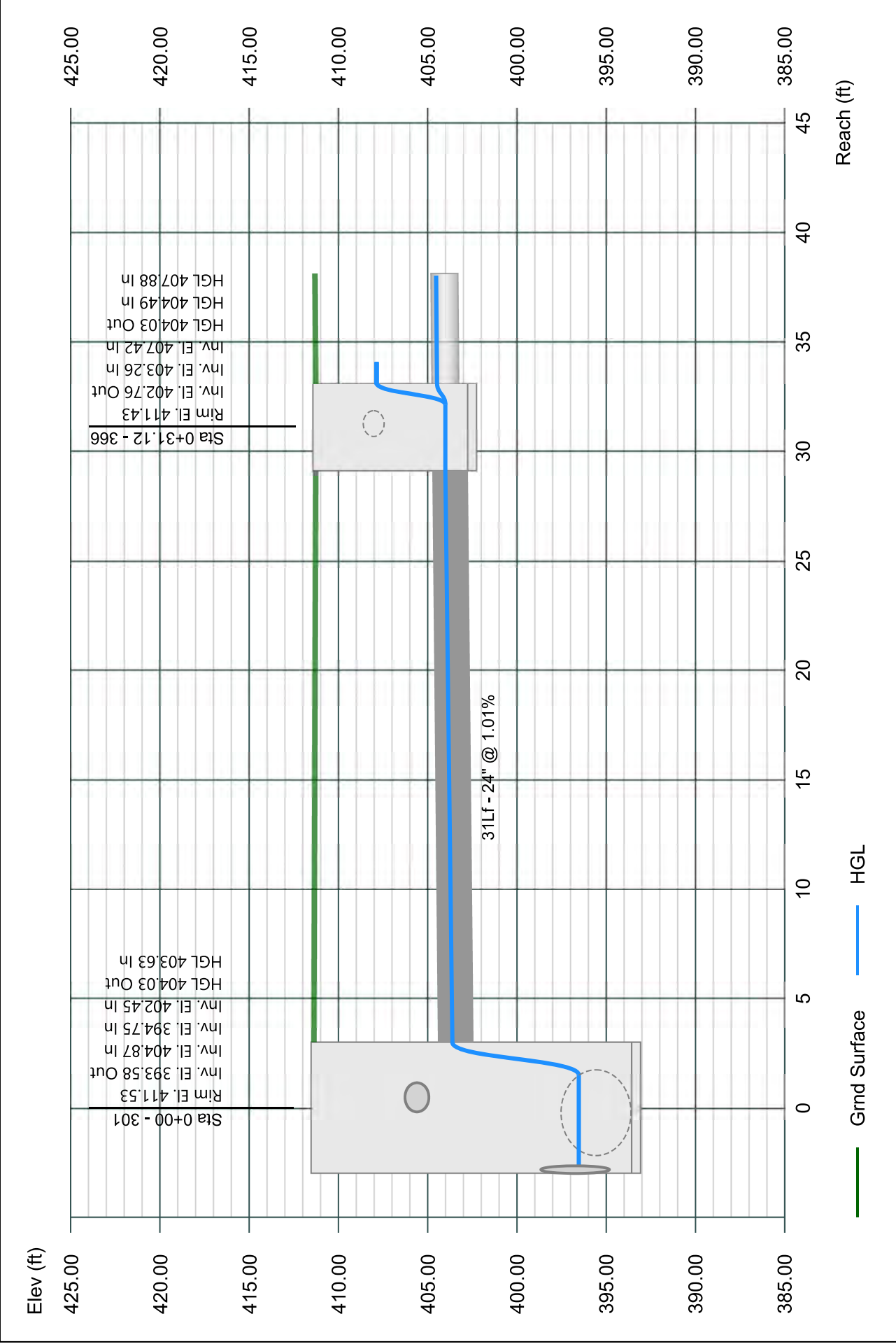

Line 66 - 367 TO 366

Stormwater Studio 2023 v 3.0.0.31

Project Name: Enter Project Name...

05-03-2023

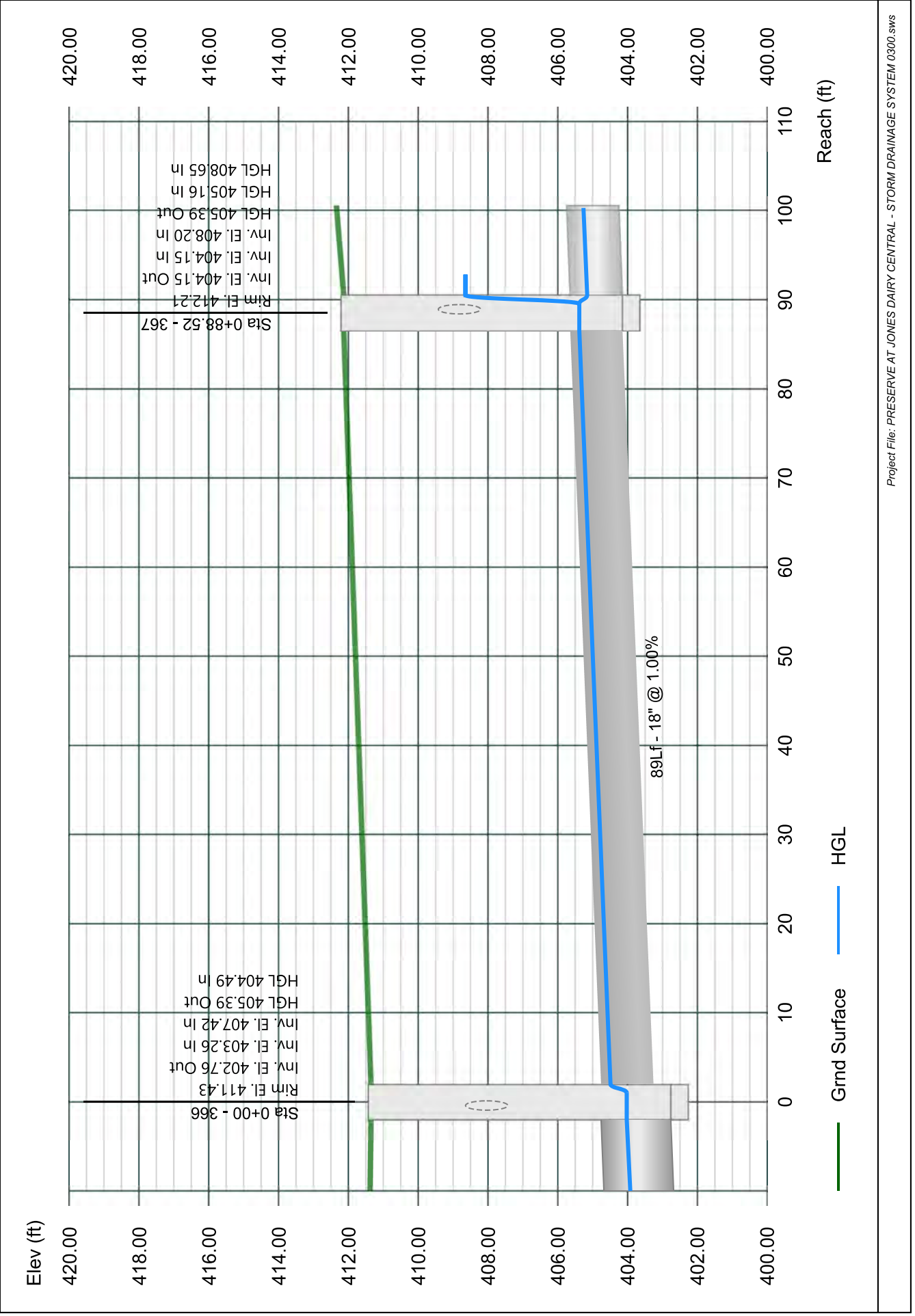

Line 67 - 368 TO 367

Stormwater Studio 2023 v 3.0.0.31

Project Name: Enter Project Name...

05-03-2023

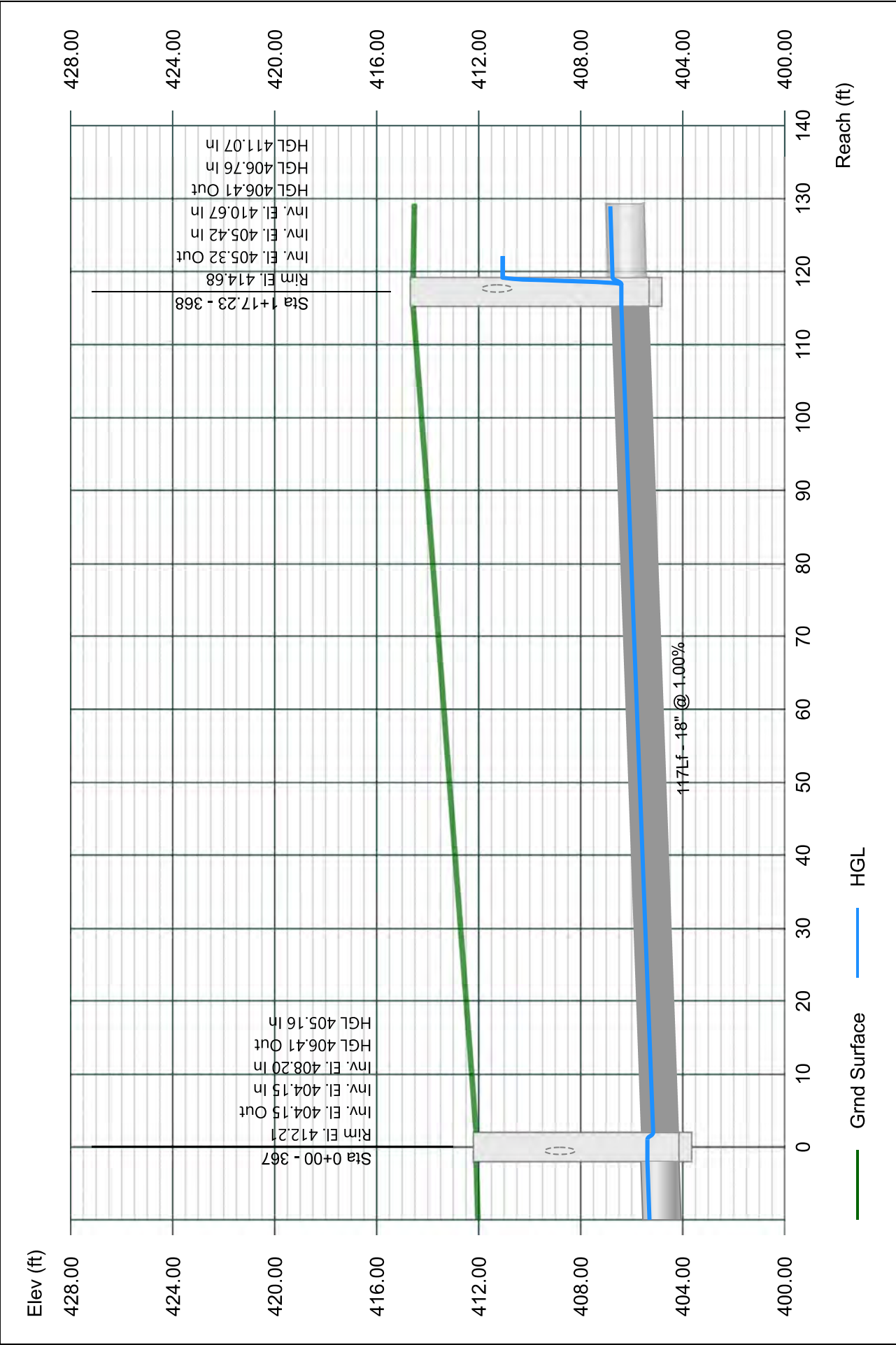

Line 68 - 368 TO 368

Stormwater Studio 2023 v 3.0.0.31

Project Name: Enter Project Name...

05-03-2023

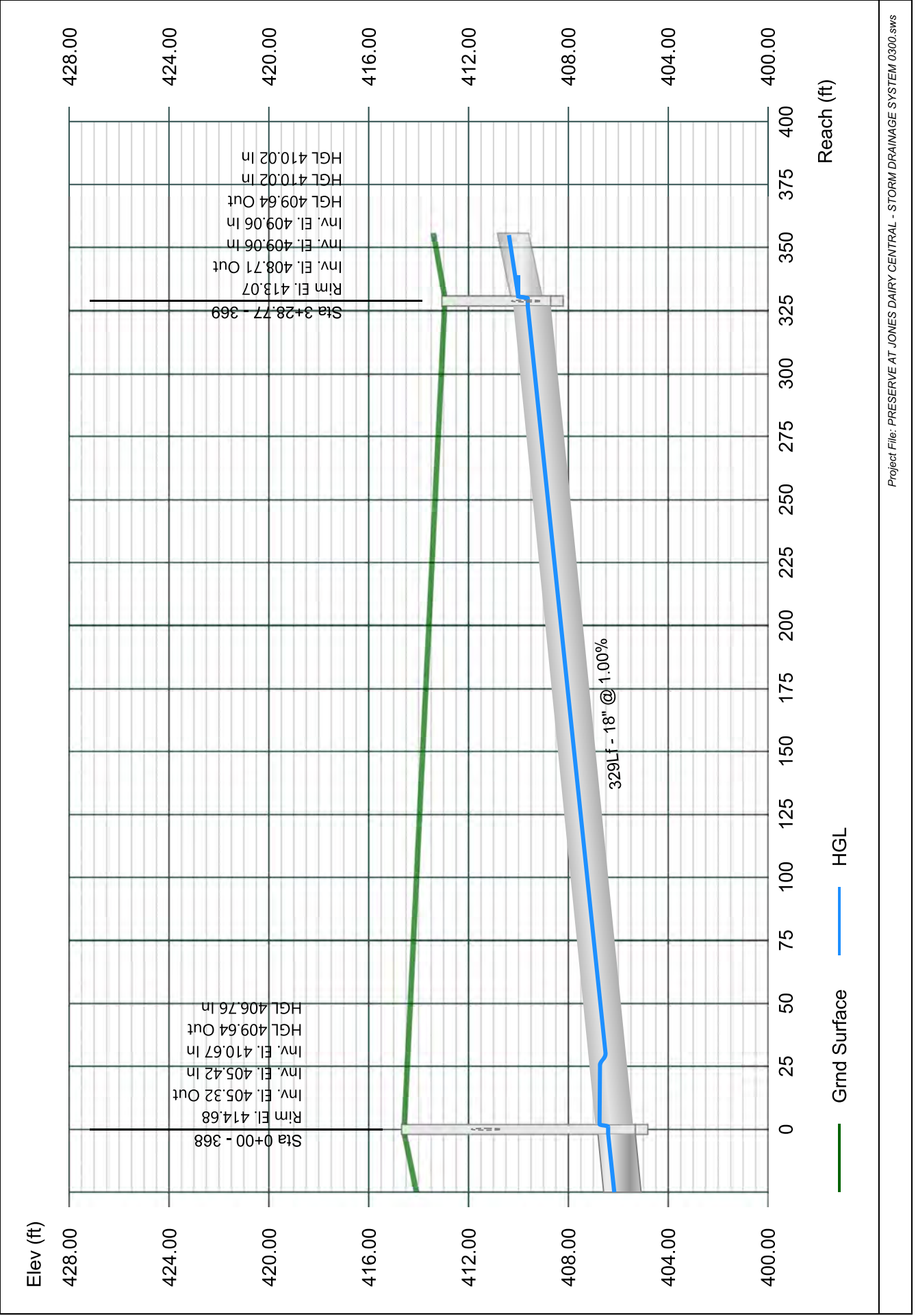

Line 69 - 370 TO 369

Stormwater Studio 2023 v 3.0.0.31

Project Name: Enter Project Name...

05-03-2023

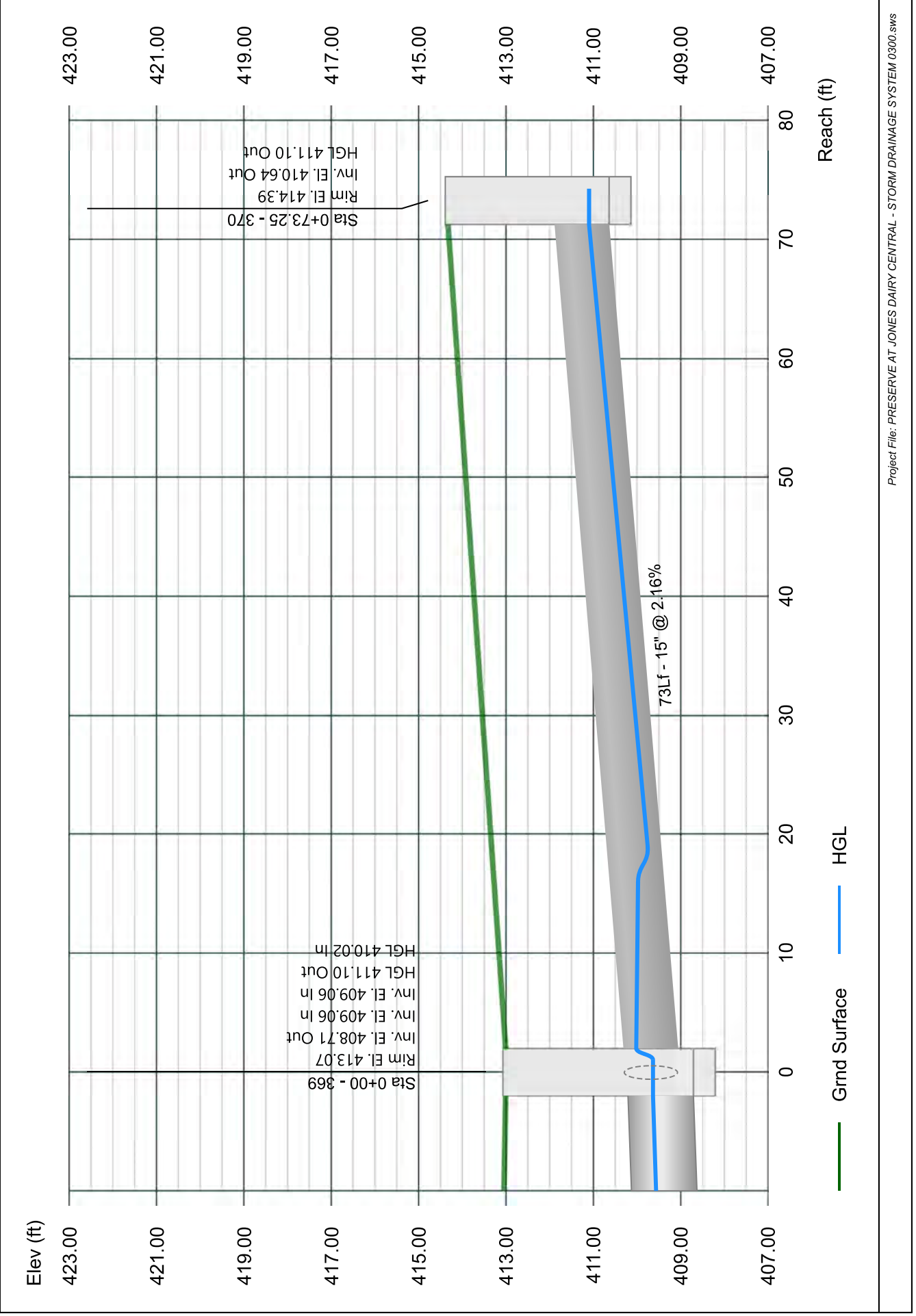

Line 70 - 374 TO 369

Stormwater Studio 2023 v 3.0.0.31

Project Name: Enter Project Name...

05-03-2023

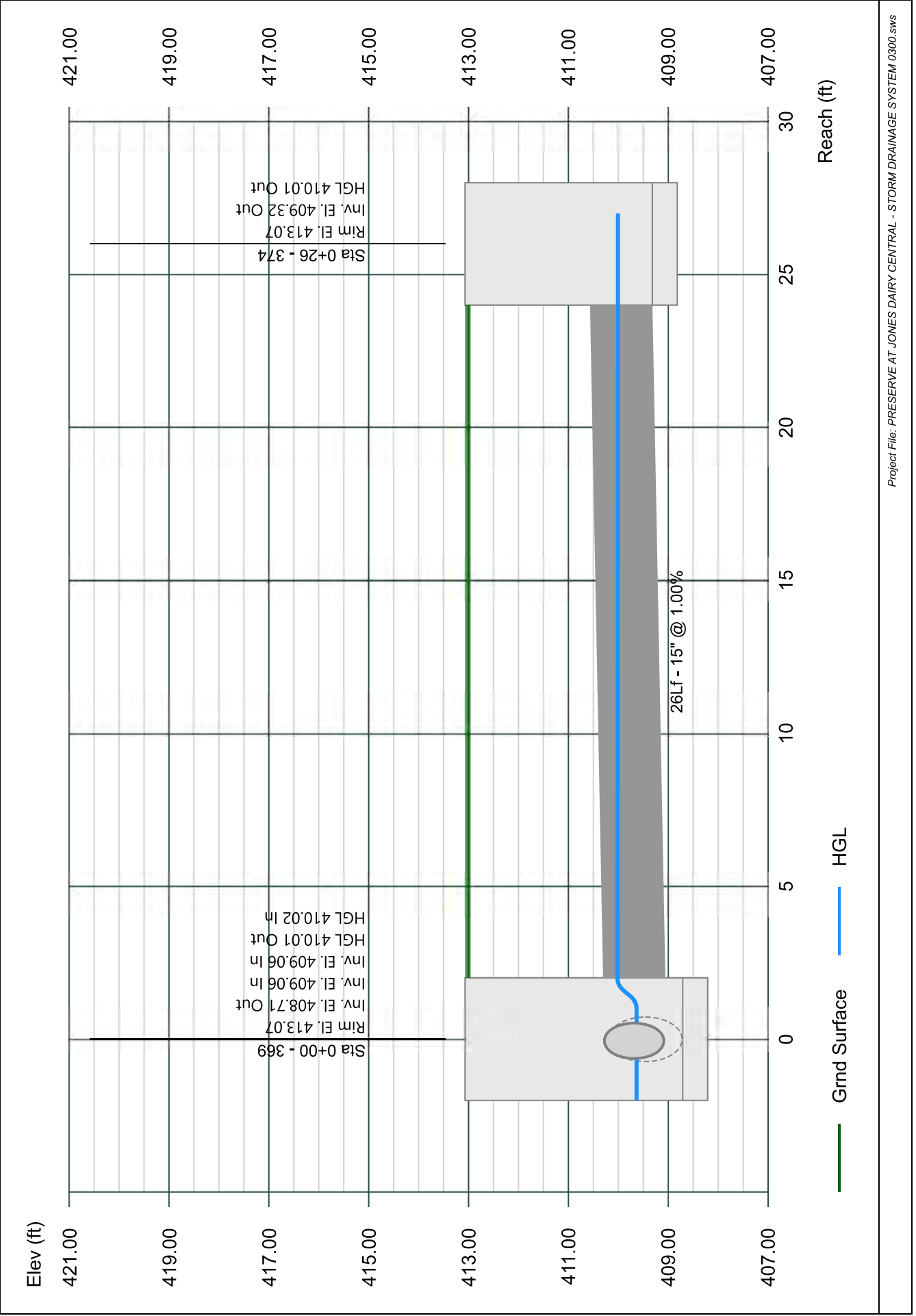

Line 71 - 383 TO 368

Stormwater Studio 2023 v 3.0.0.31

Project Name: Enter Project Name...

05-03-2023

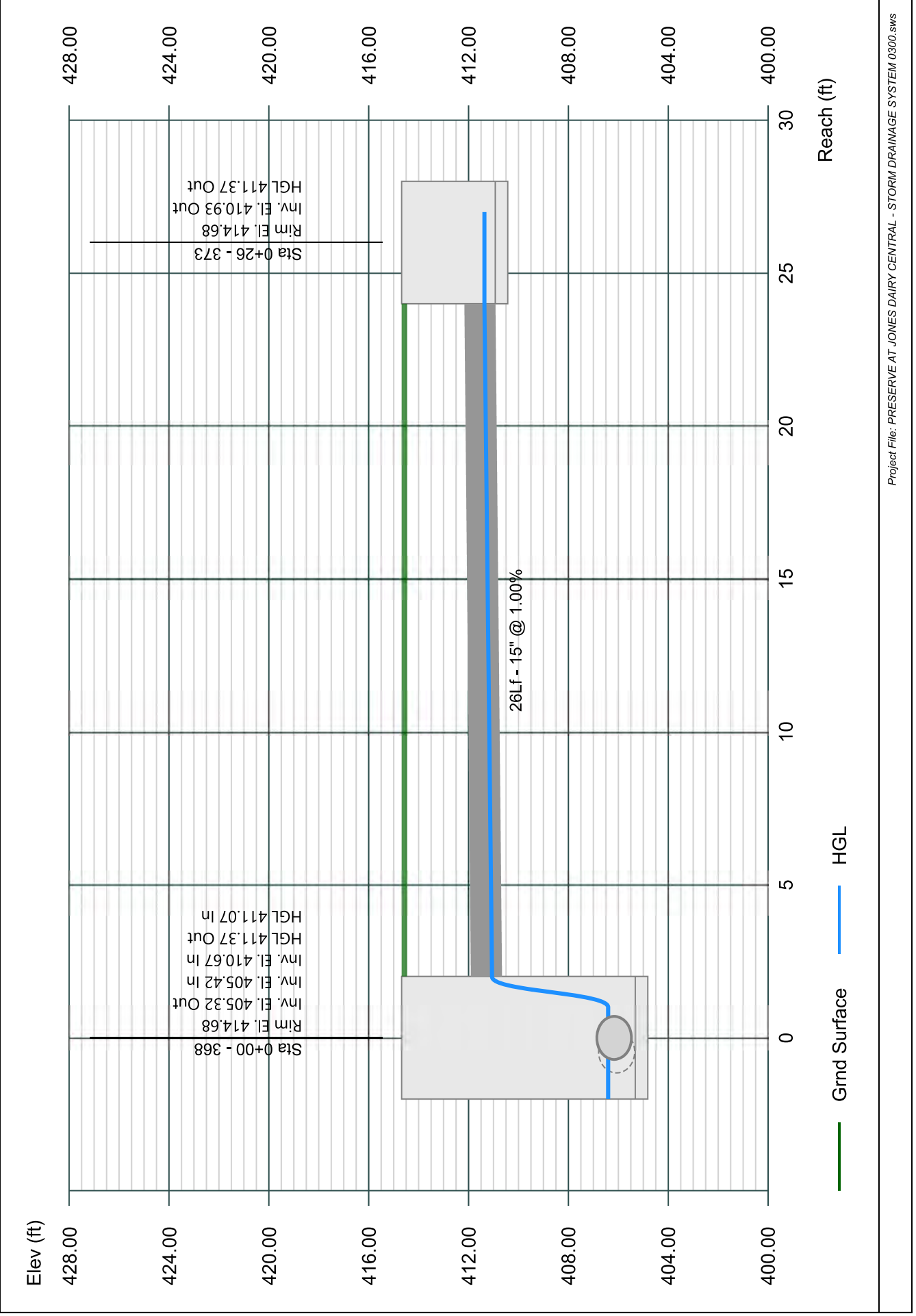

Line 72 - 372 TO 367

Stormwater Studio 2023 v 3.0.0.31

Project Name: Enter Project Name...

05-03-2023

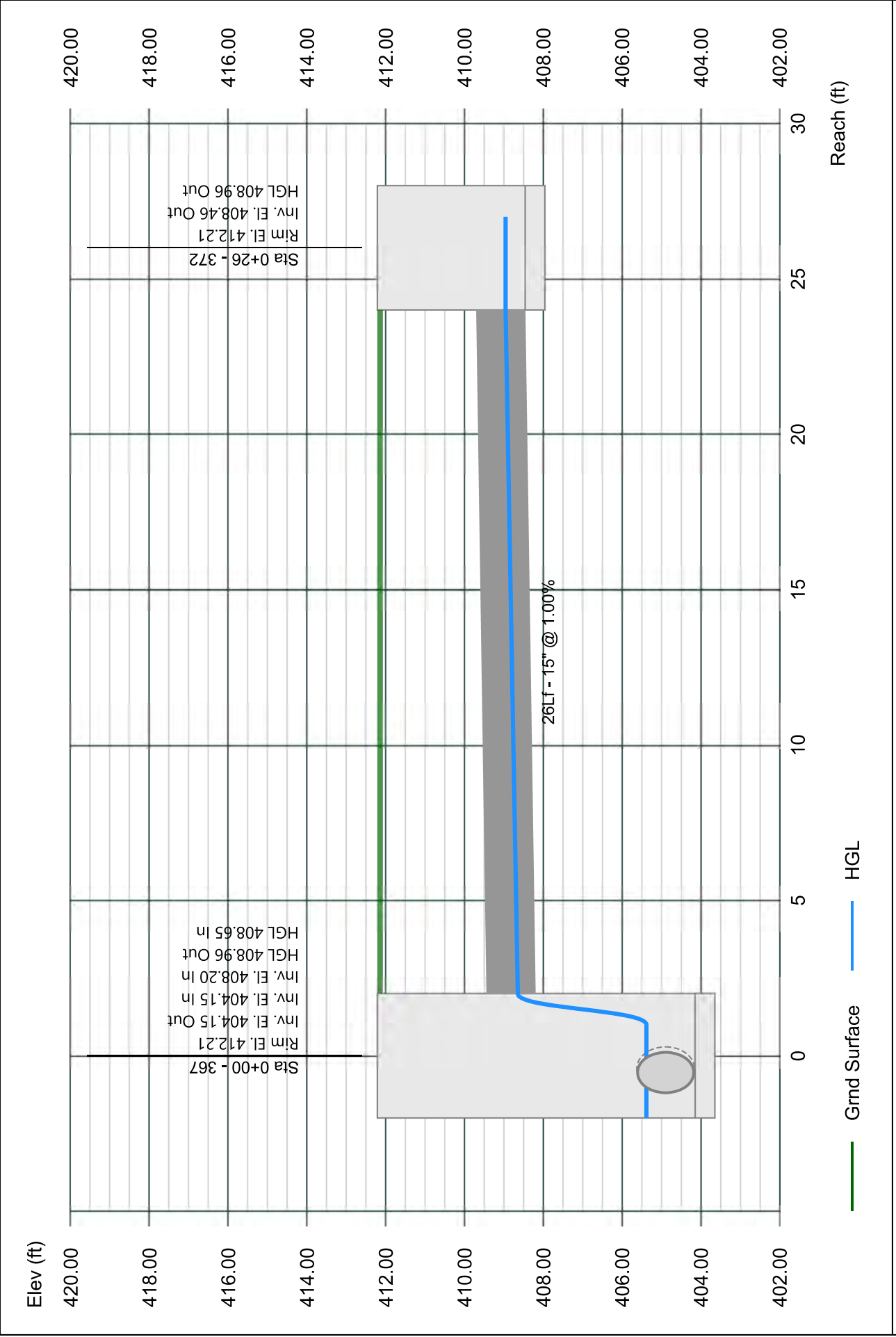

Line 73 - 371 TO 366

Stormwater Studio 2023 v 3.0.0.31

Project Name: Enter Project Name...

05-03-2023

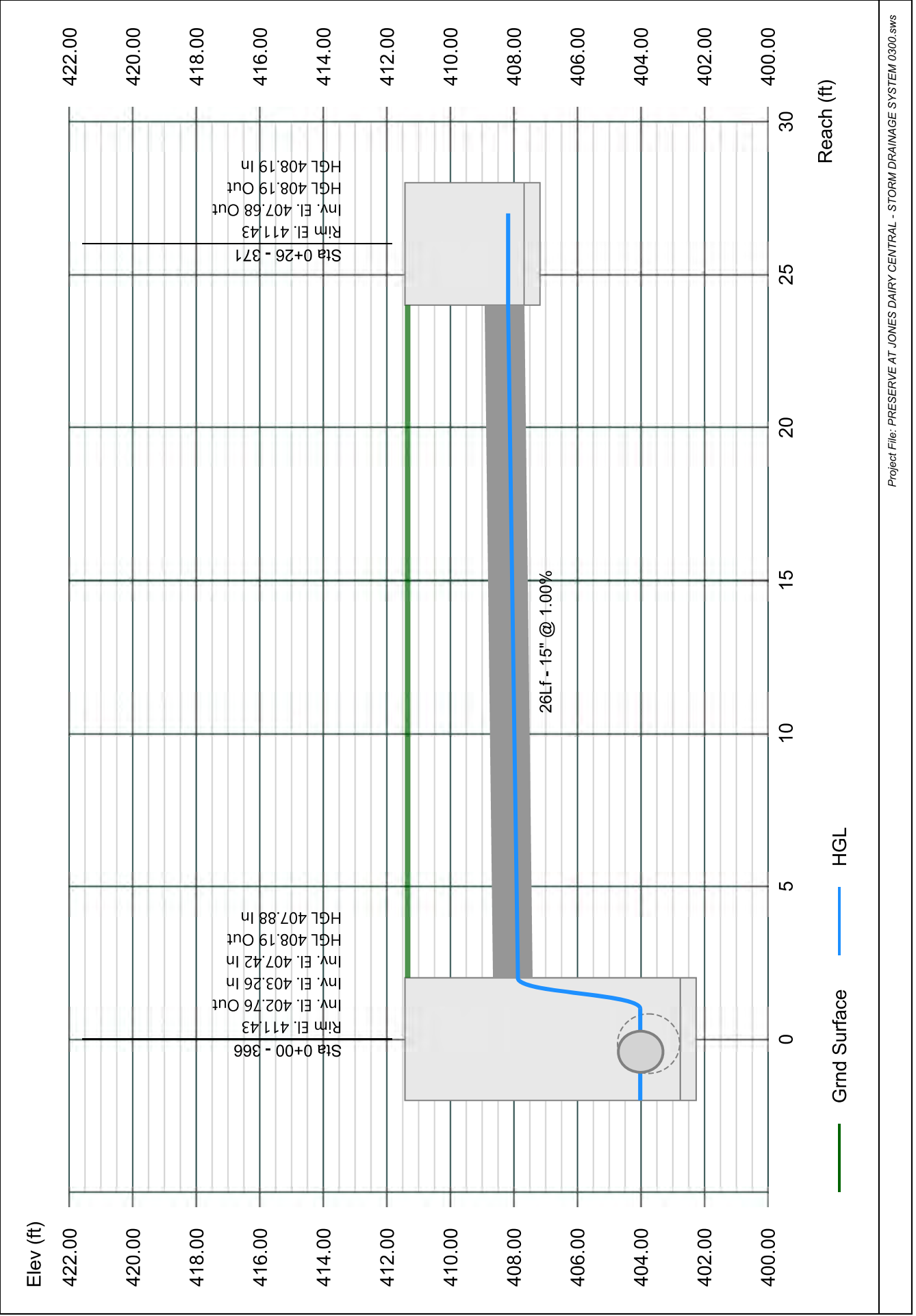

25-YEAR HGL

Line 1 - 101 TO 100

Stormwater Studio 2024 v 3.0.0.33

Project Name: Enter Project Name...

01-19-2024

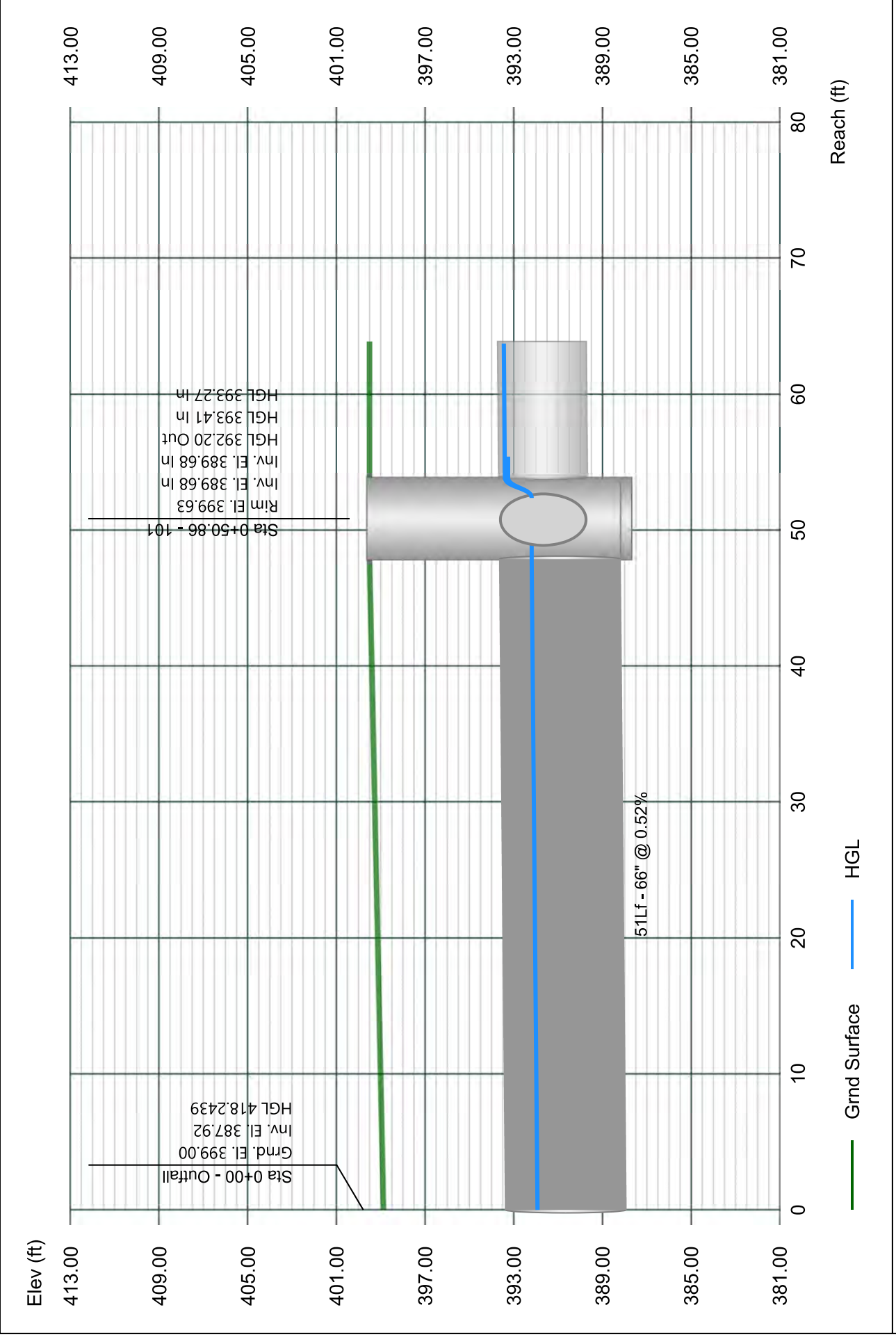

Line 2 - 102 TO 101

Stormwater Studio 2024 v 3.0.0.33

Project Name: Enter Project Name...

01-19-2024

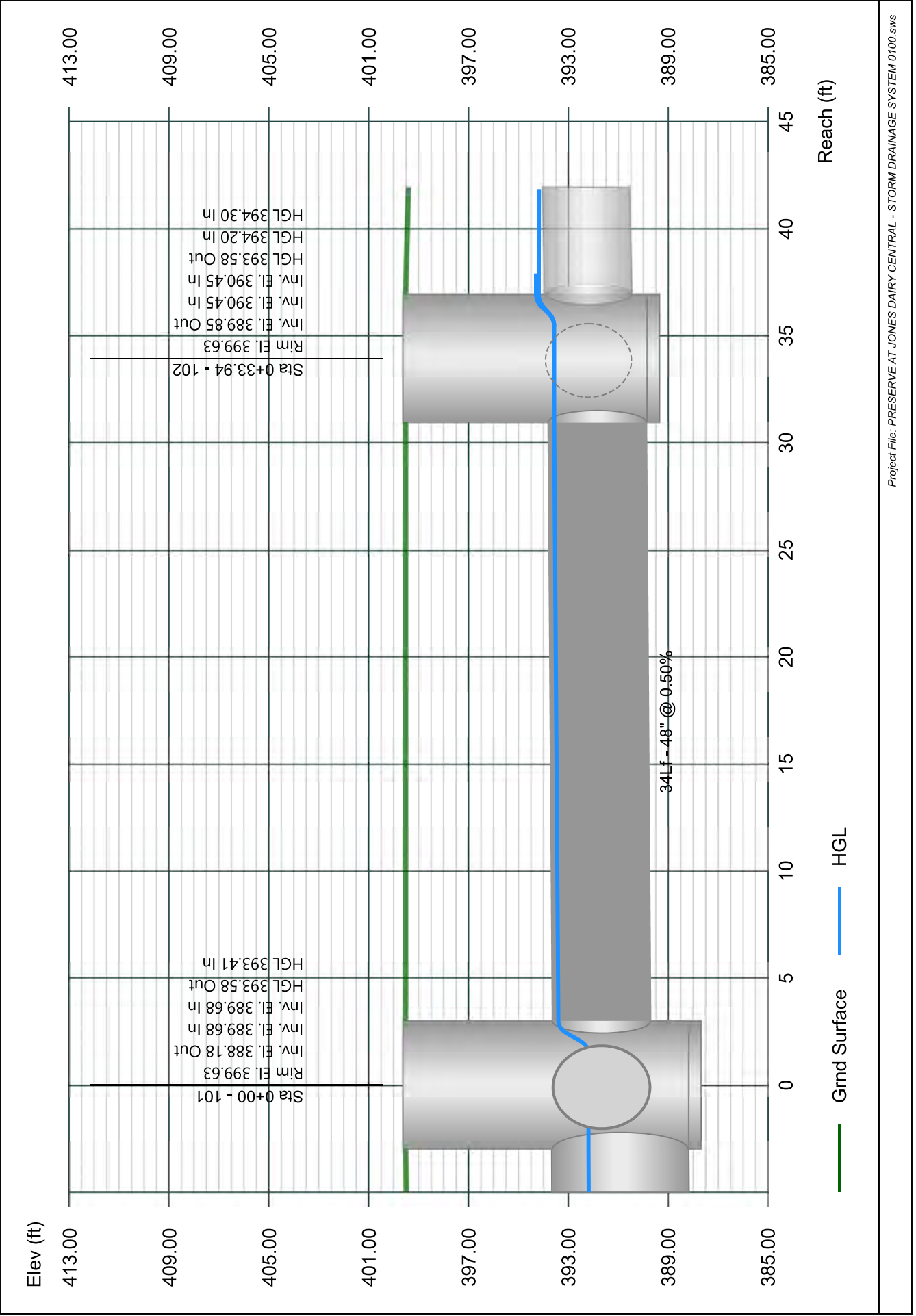

Line 3 - 103 TO 102

Stormwater Studio 2024 v 3.0.0.33

Project Name: Enter Project Name...

01-19-2024

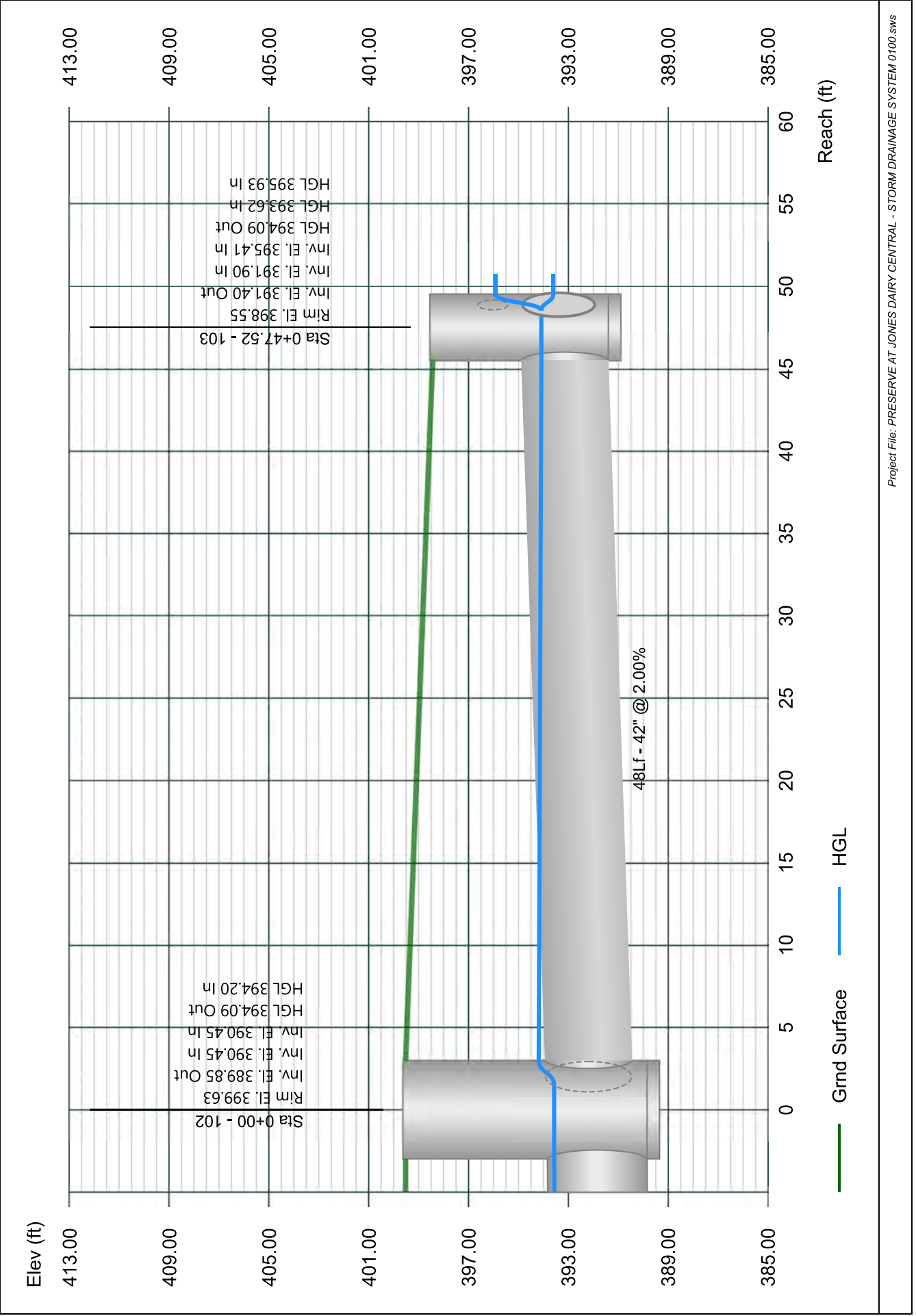

Line 4 - 104 TO 103

Stormwater Studio 2024 v 3.0.0.33

Project Name: Enter Project Name...

01-19-2024

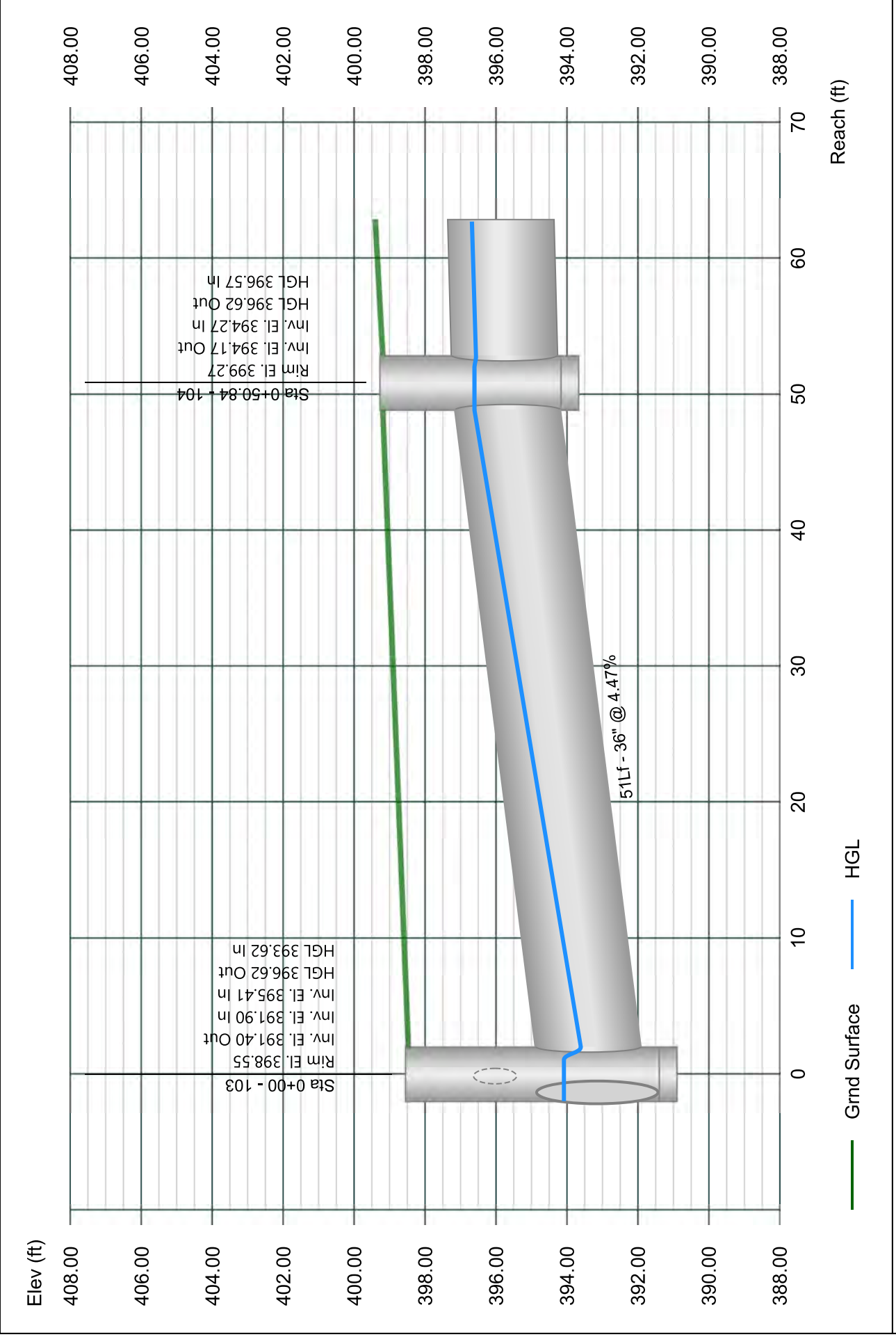

Line 5 - 105 TO 104

Stormwater Studio 2024 v 3.0.0.33

Project Name: Enter Project Name...

01-19-2024

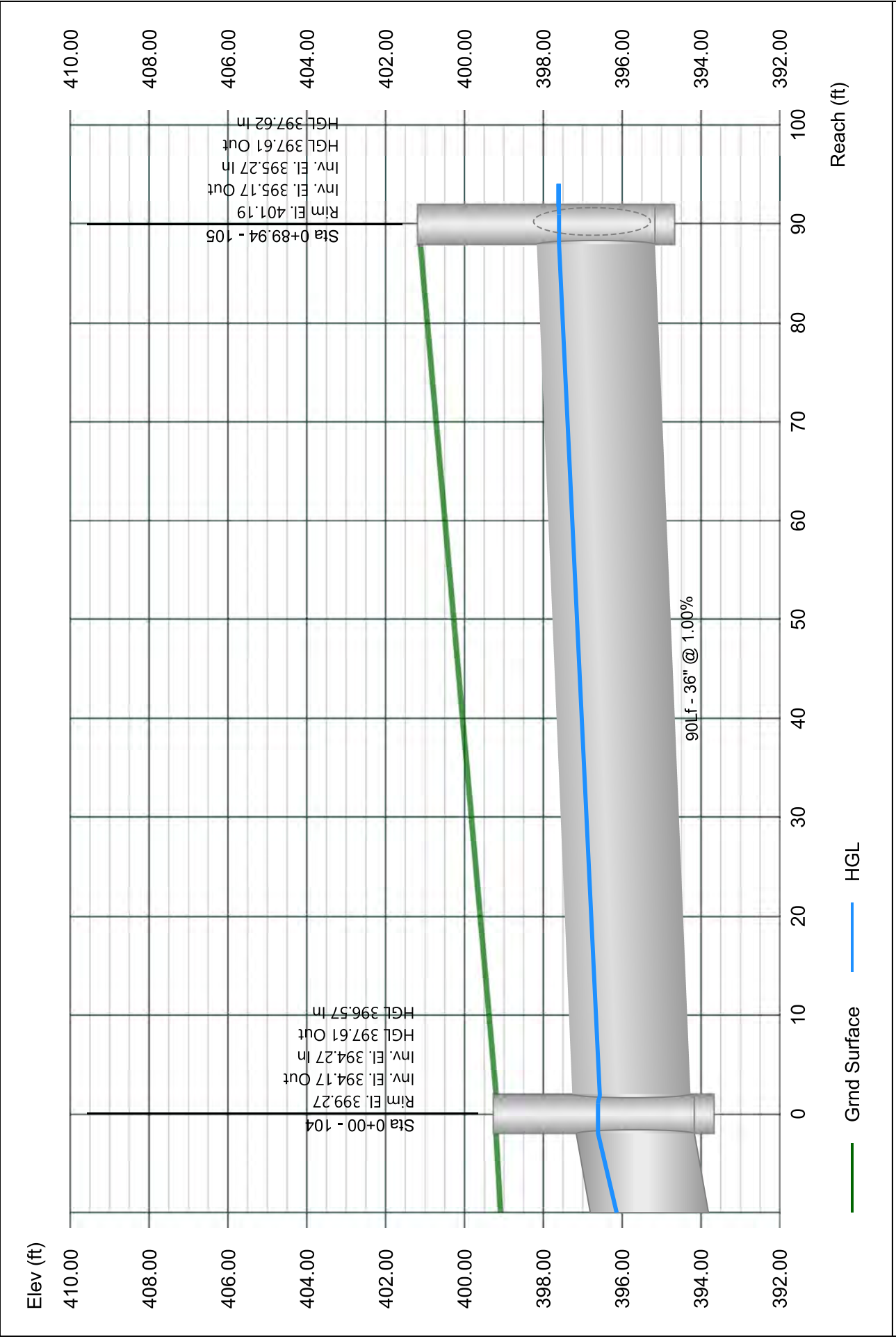

Line 6 - 106 TO 105

Stormwater Studio 2024 v 3.0.0.33

Project Name: Enter Project Name...

01-19-2024

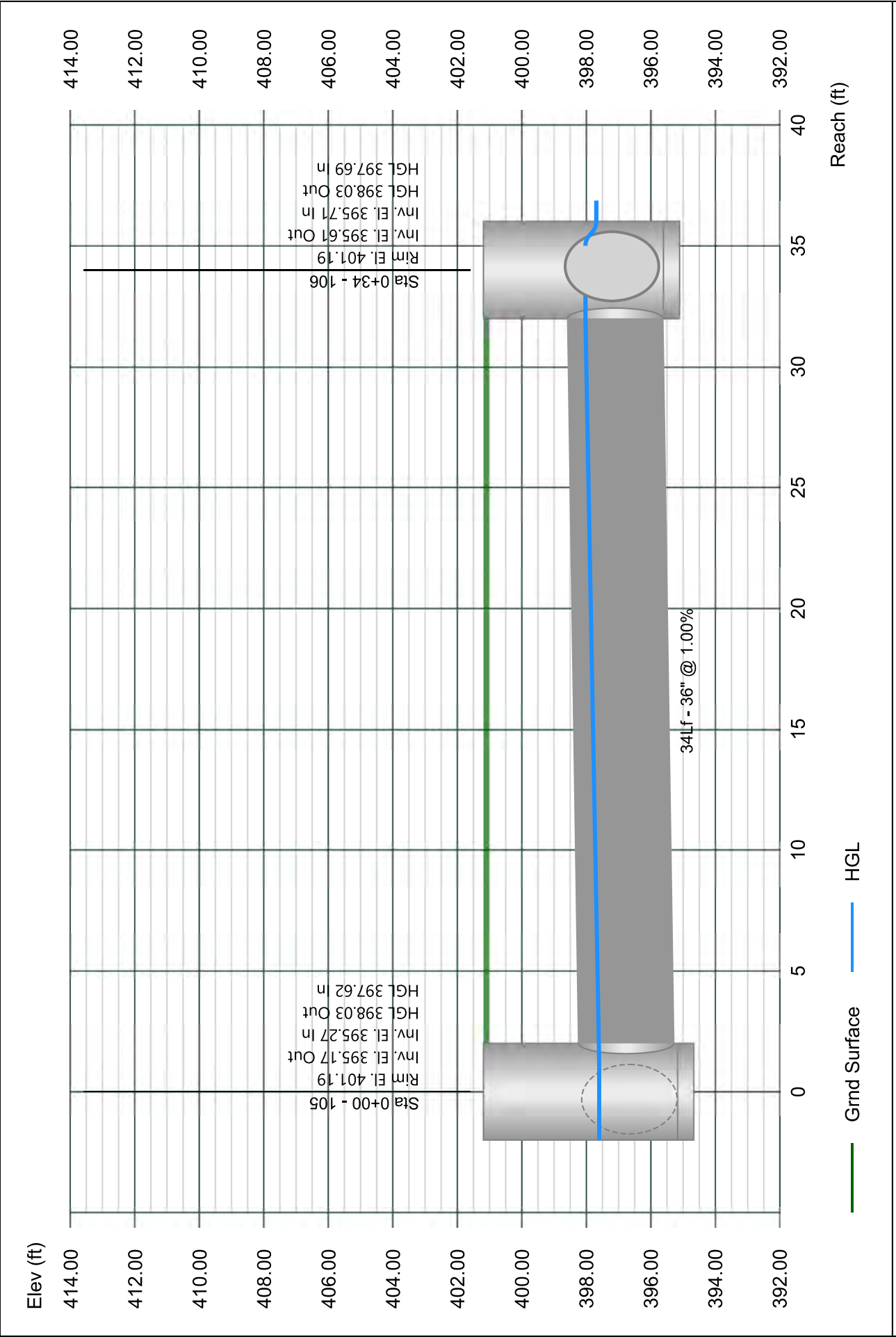

Line 7 - 107 TO 106

Stormwater Studio 2024 v 3.0.0.33

Project Name: Enter Project Name...

01-19-2024

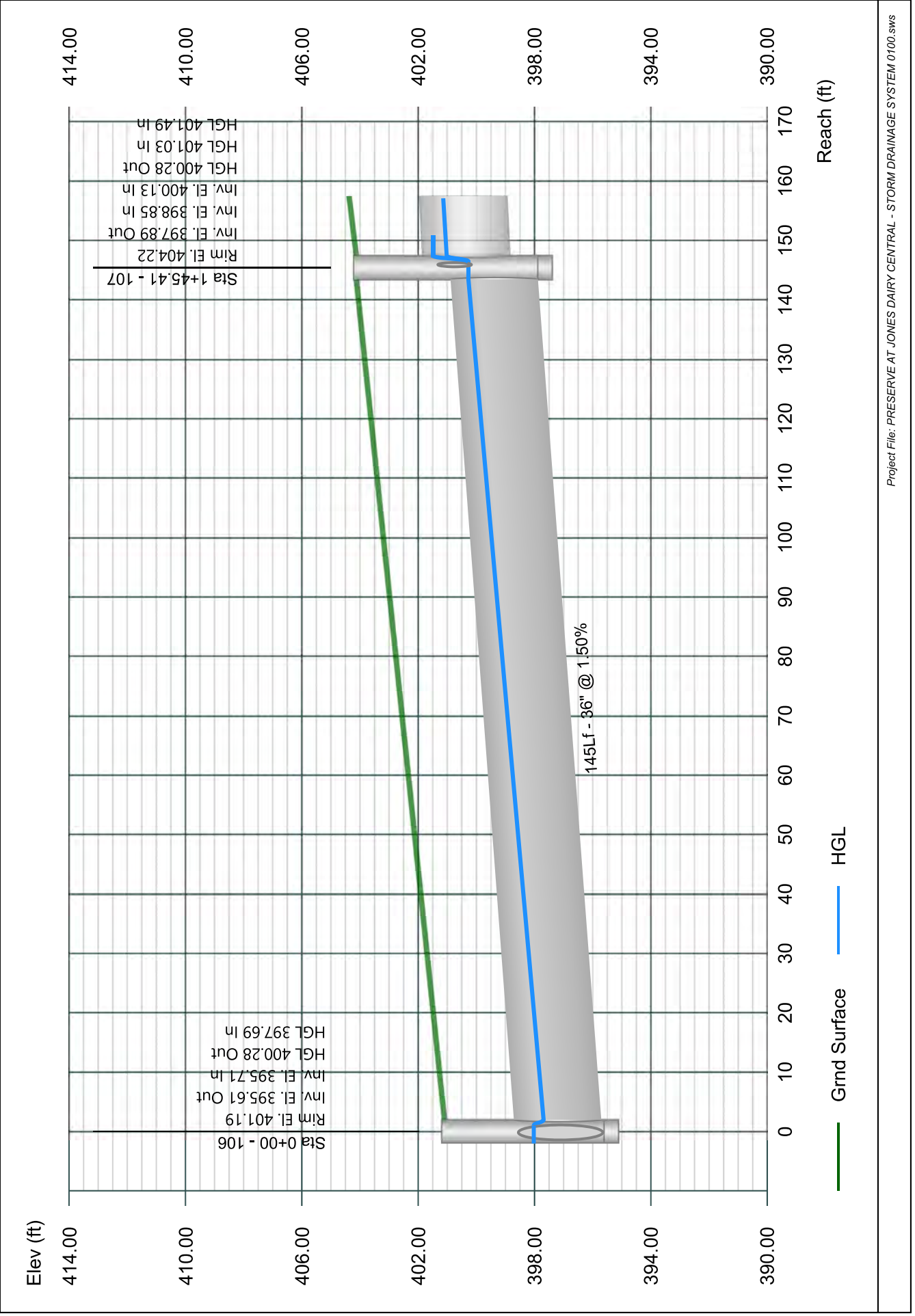

Line 8 - 108 TO 107

Stormwater Studio 2024 v 3.0.0.33

Project Name: Enter Project Name...

01-19-2024

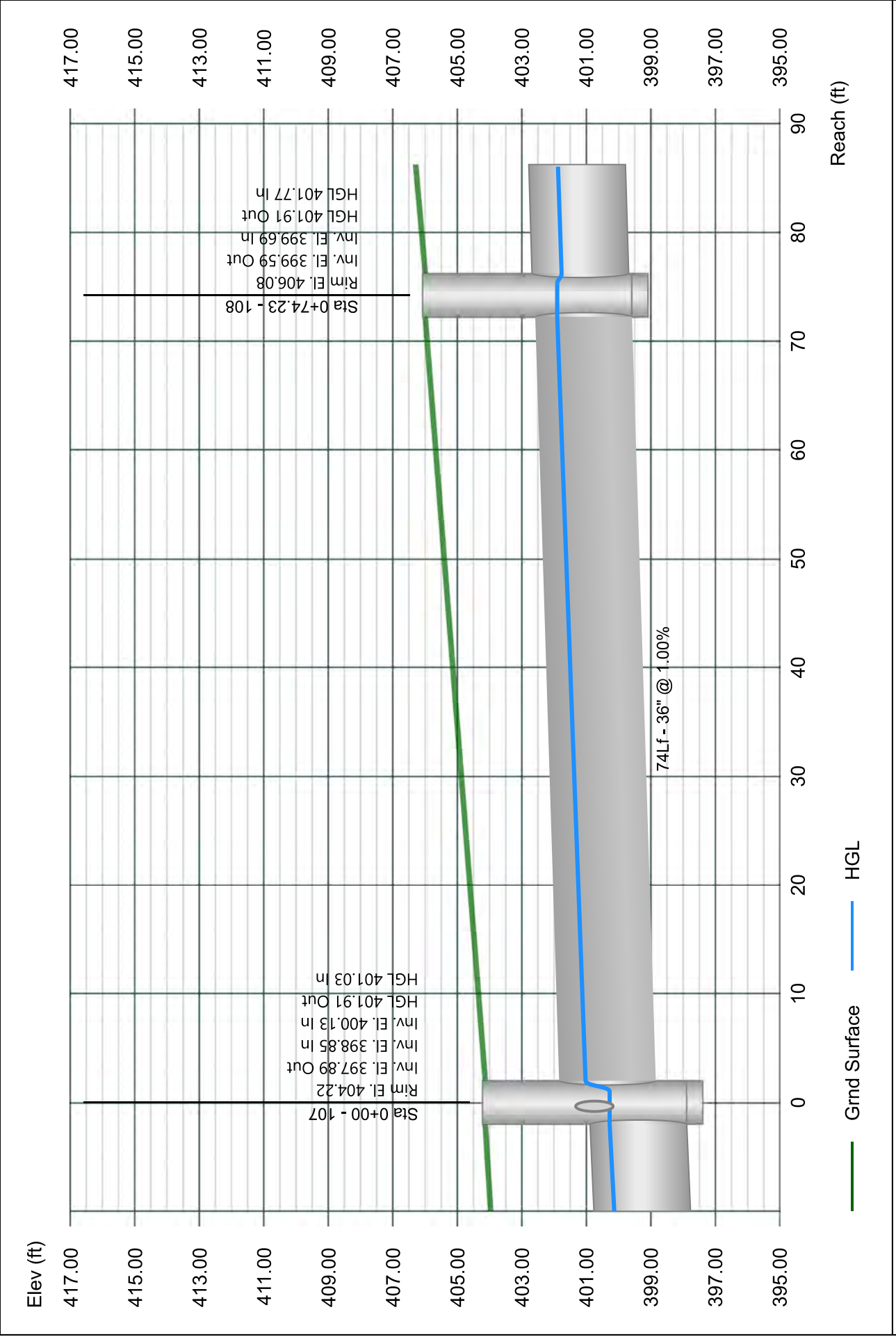

Line 9 - 109 TO 108

Stormwater Studio 2024 v 3.0.0.33

Project Name: Enter Project Name...

01-19-2024

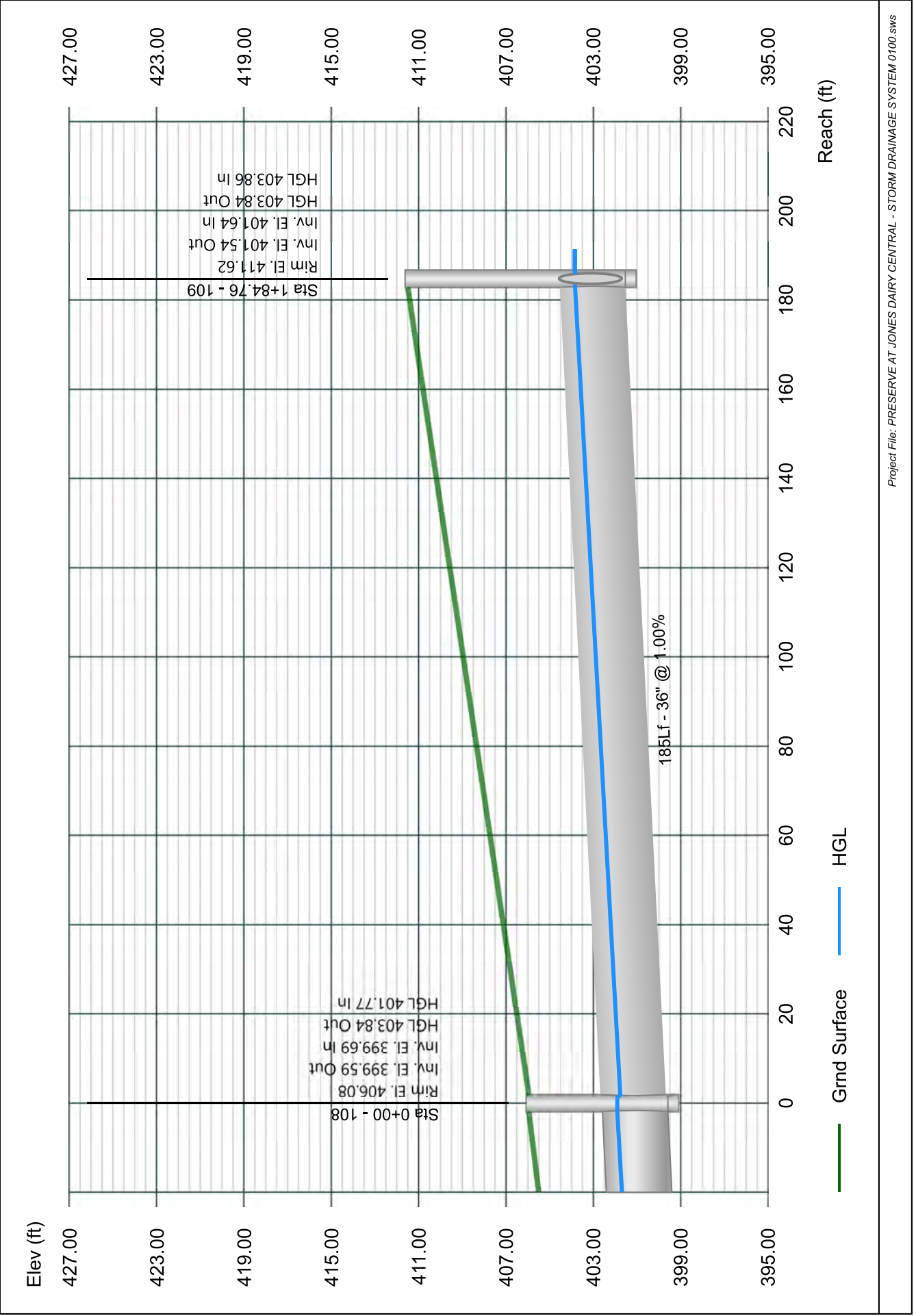

Line 10 - 110 TO 109

Stormwater Studio 2024 v 3.0.0.33

Project Name: Enter Project Name...

01-19-2024

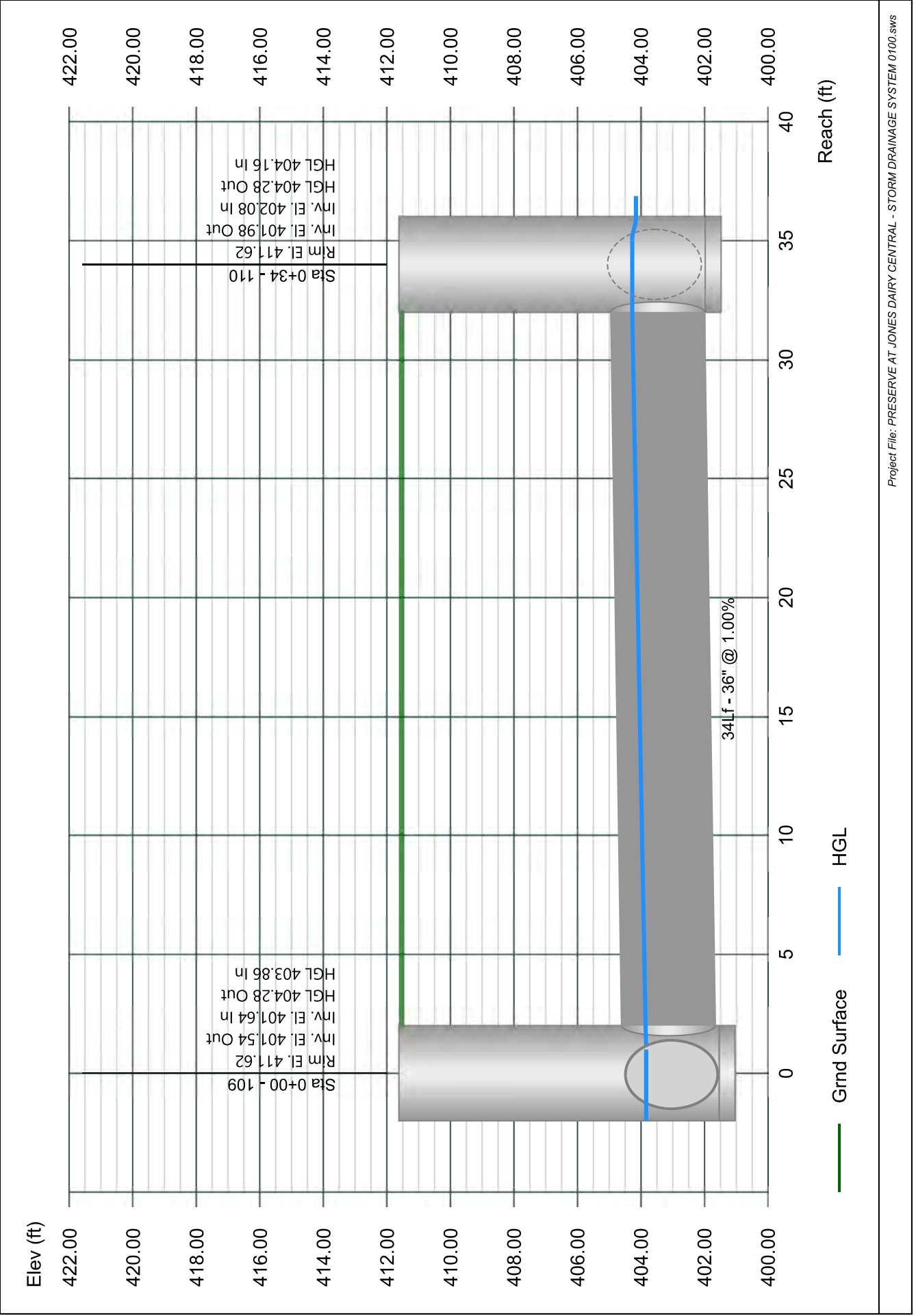

Line 11 - 111 TO 110

Stormwater Studio 2024 v 3.0.0.33

Project Name: Enter Project Name...

01-19-2024

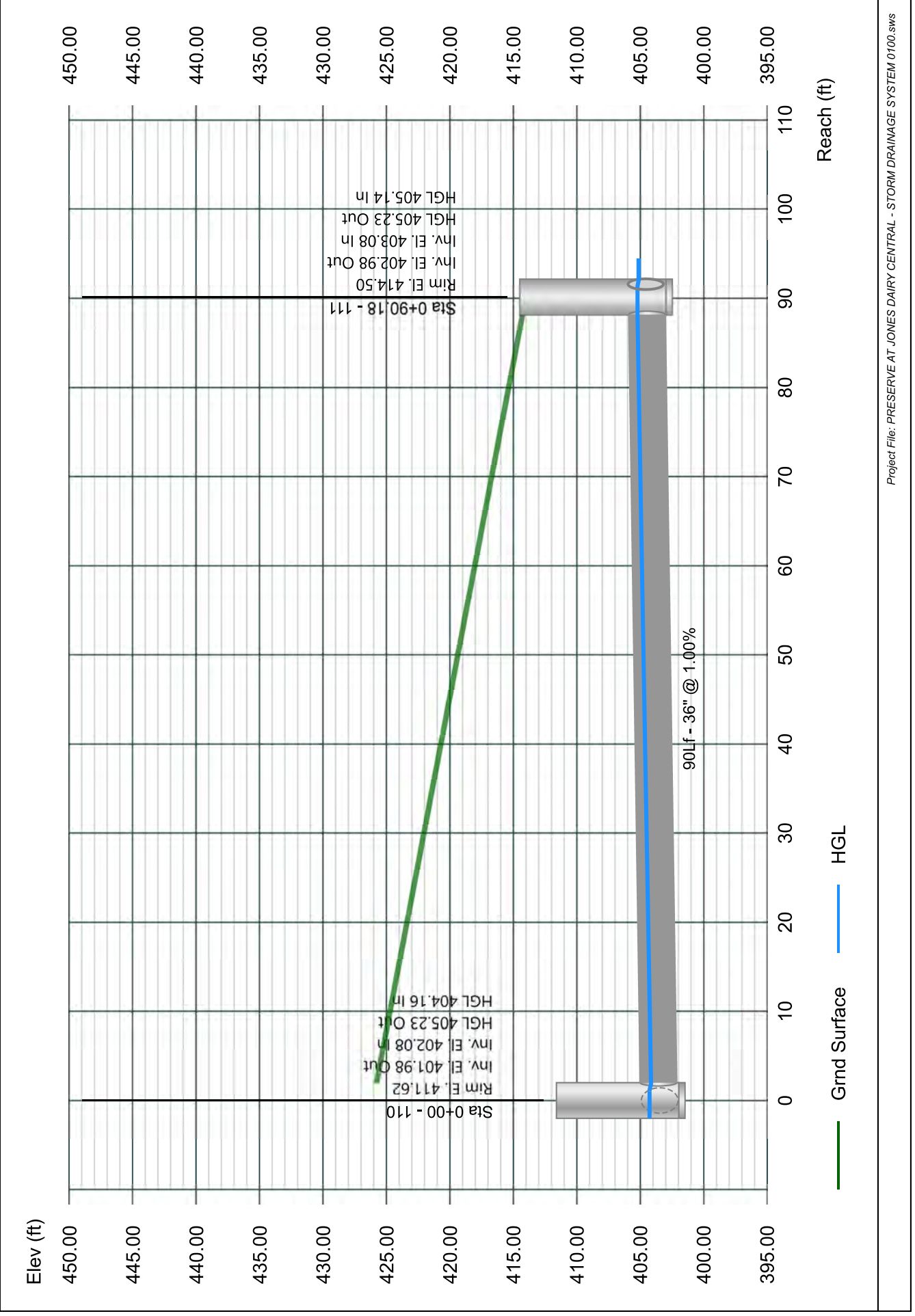

Line 12 - 112 TO 111

Stormwater Studio 2024 v 3.0.0.33

Project Name: Enter Project Name...

01-19-2024

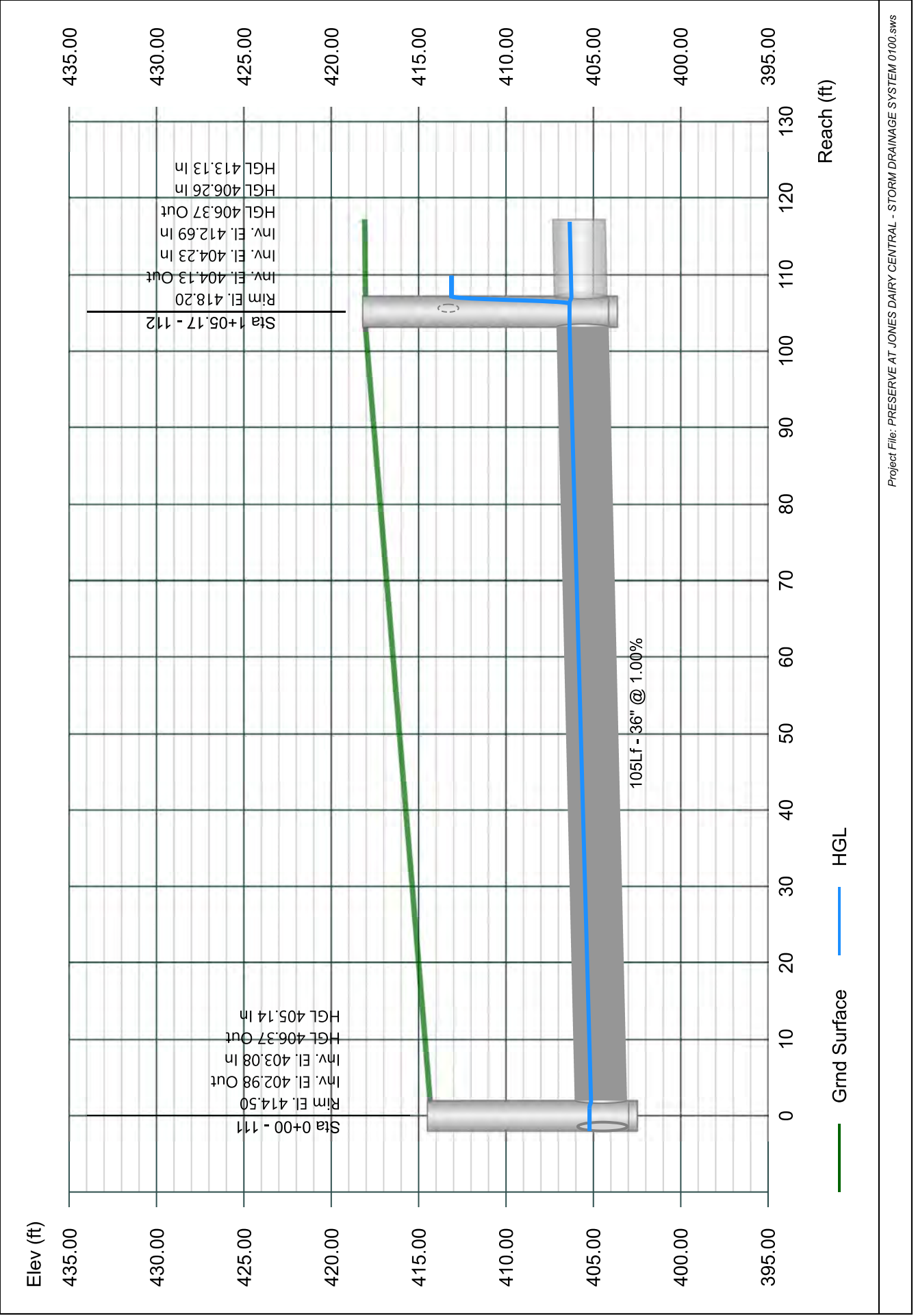

Line 13 - 113 TO 112

Stormwater Studio 2024 v 3.0.0.33

Project Name: Enter Project Name...

01-19-2024

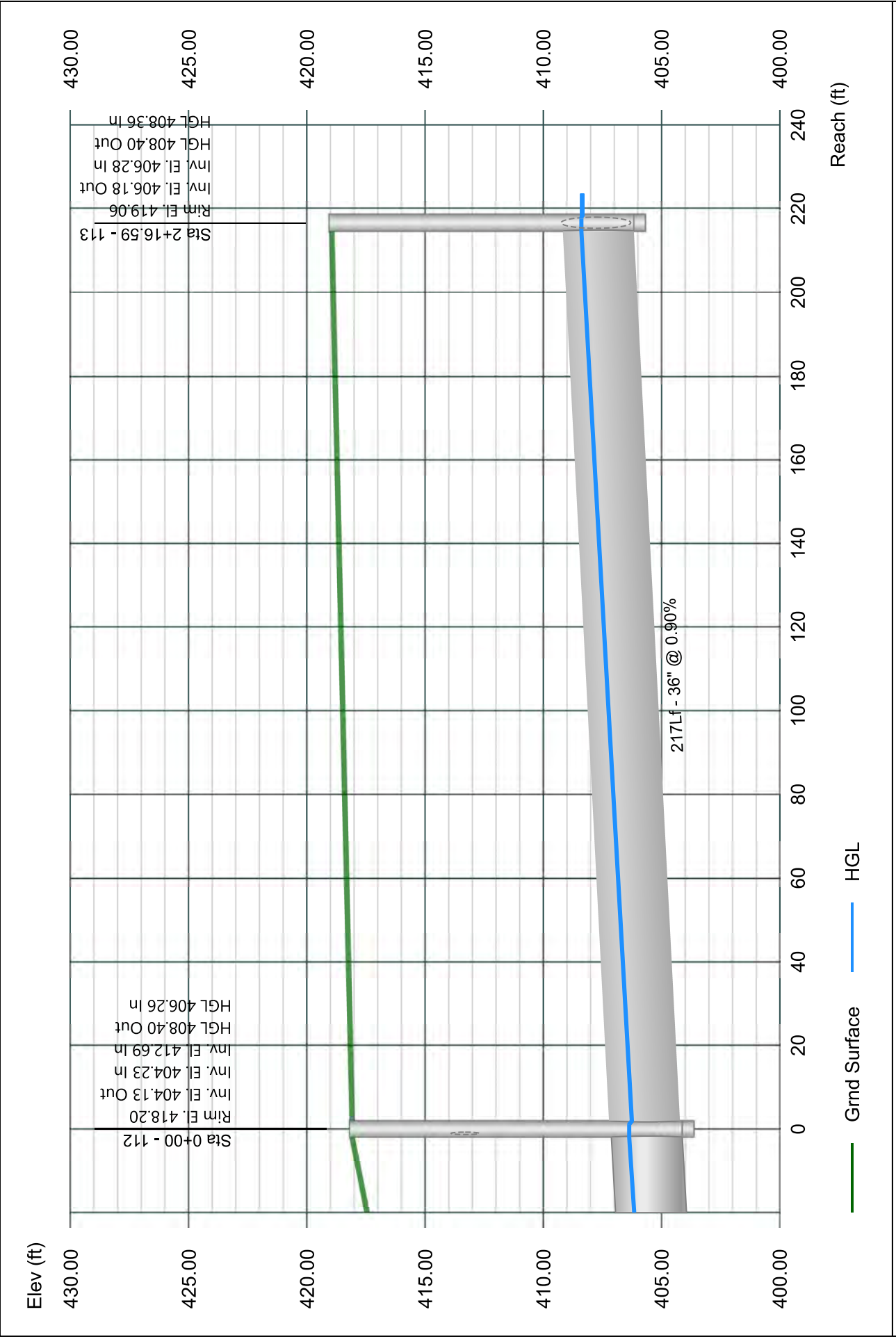

Line 14 - 114 TO 113

Stormwater Studio 2024 v 3.0.0.33

Project Name: Enter Project Name...

01-19-2024

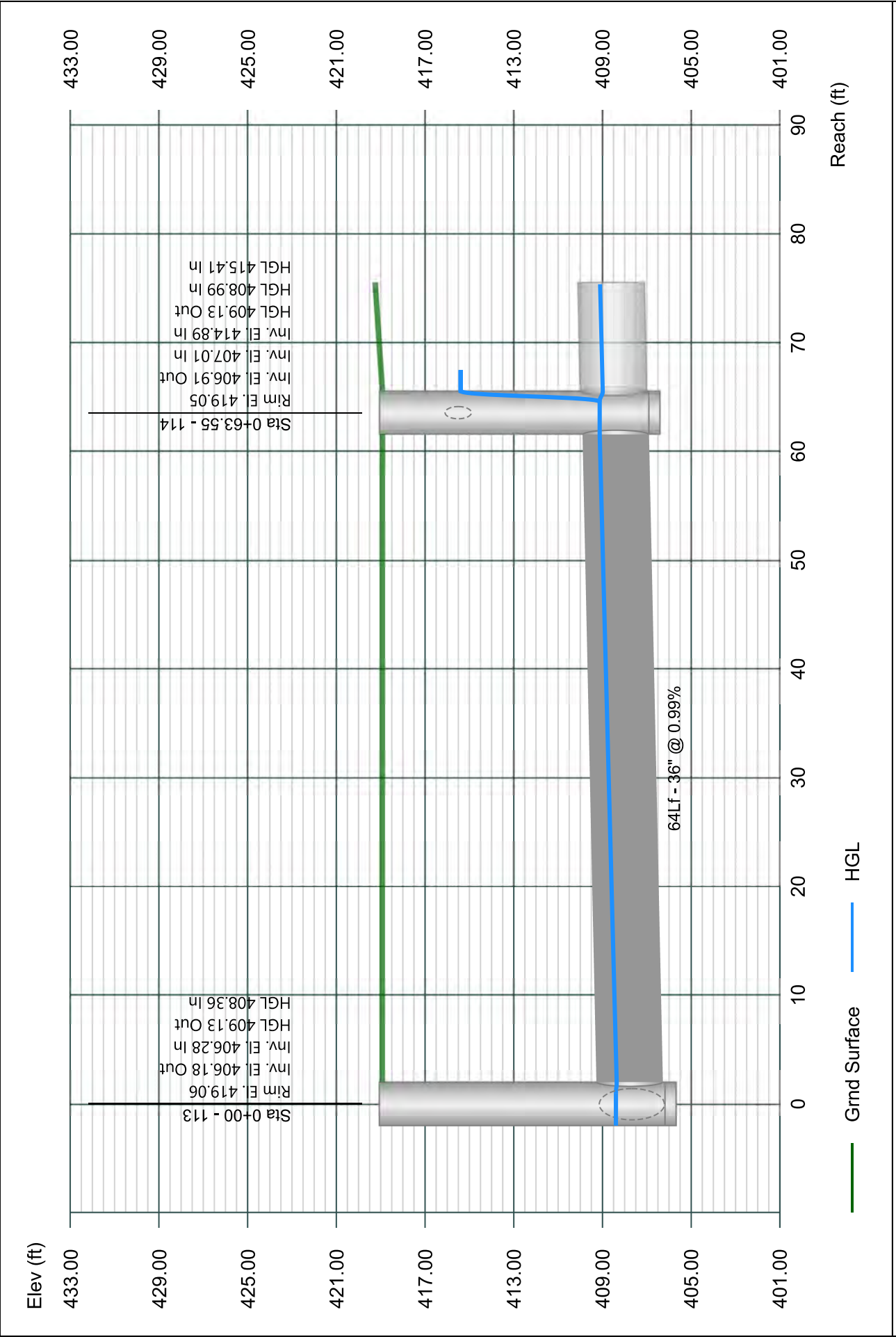

Line 15 - 115 TO 114

Stormwater Studio 2024 v 3.0.0.33

Project Name: Enter Project Name...

01-19-2024

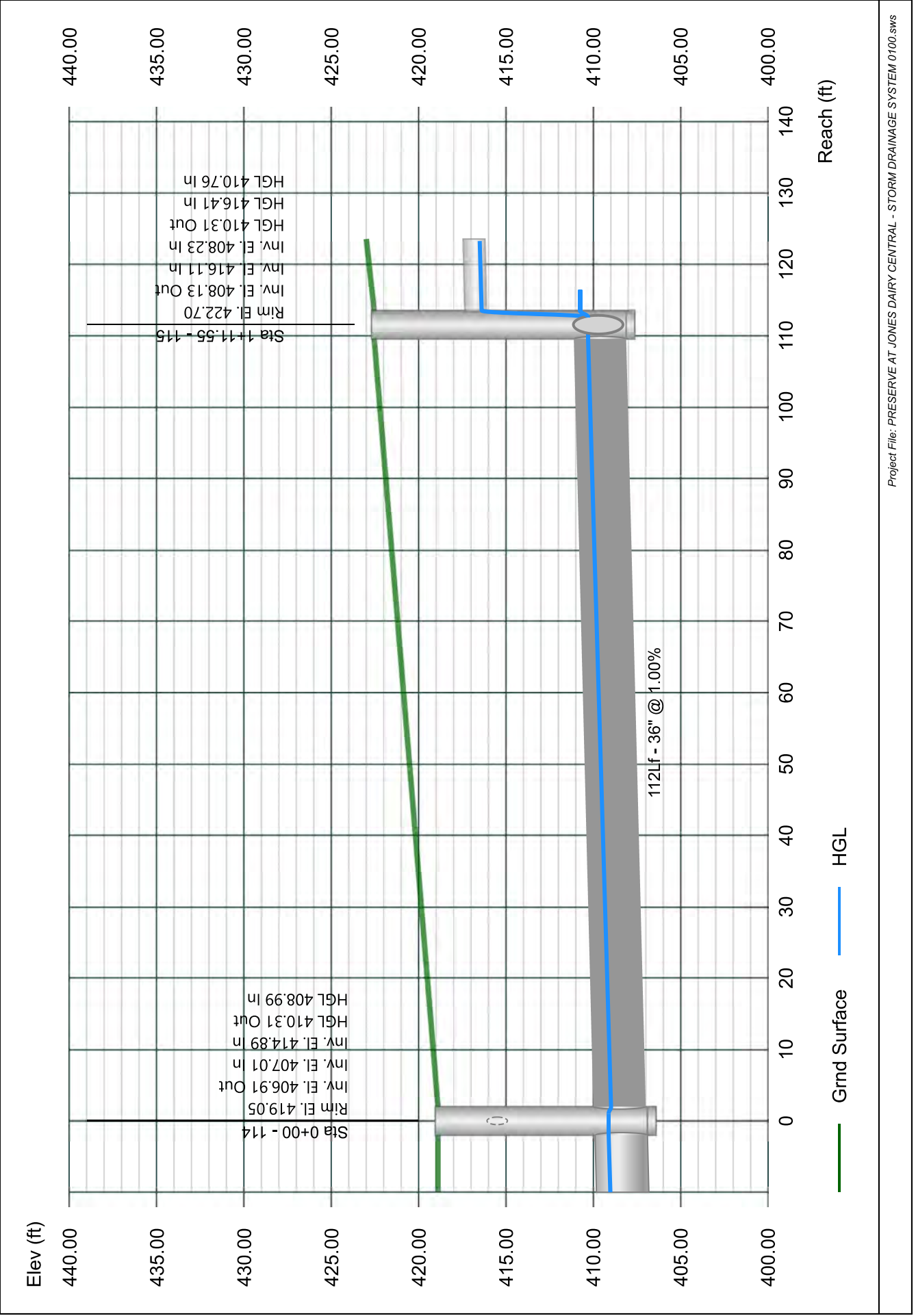

Line 16 - 116 TO 115

Stormwater Studio 2024 v 3.0.0.33

Project Name: Enter Project Name...

01-19-2024

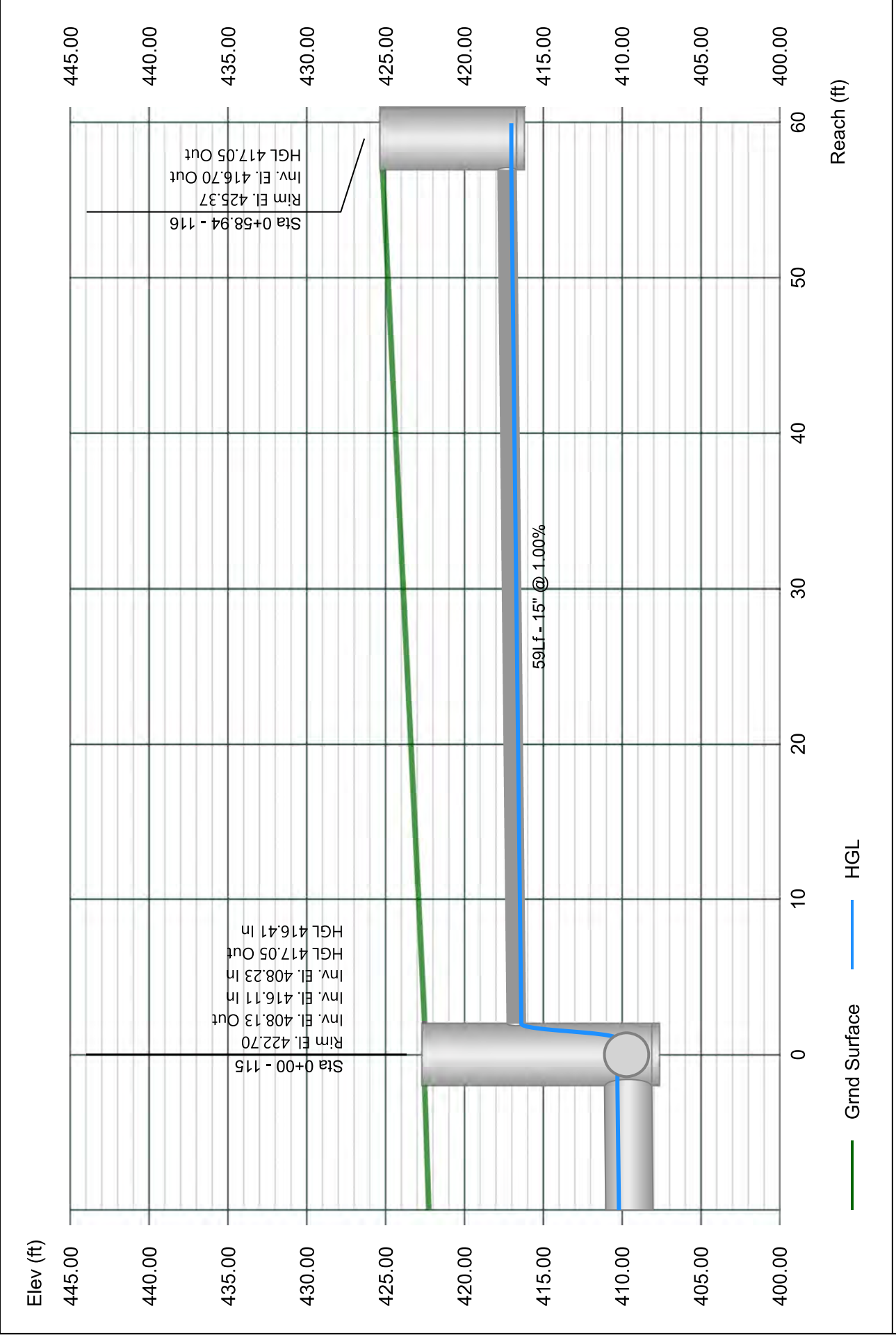

Line 17 - 117 TO 115

Stormwater Studio 2024 v 3.0.0.33

Project Name: Enter Project Name...

01-19-2024

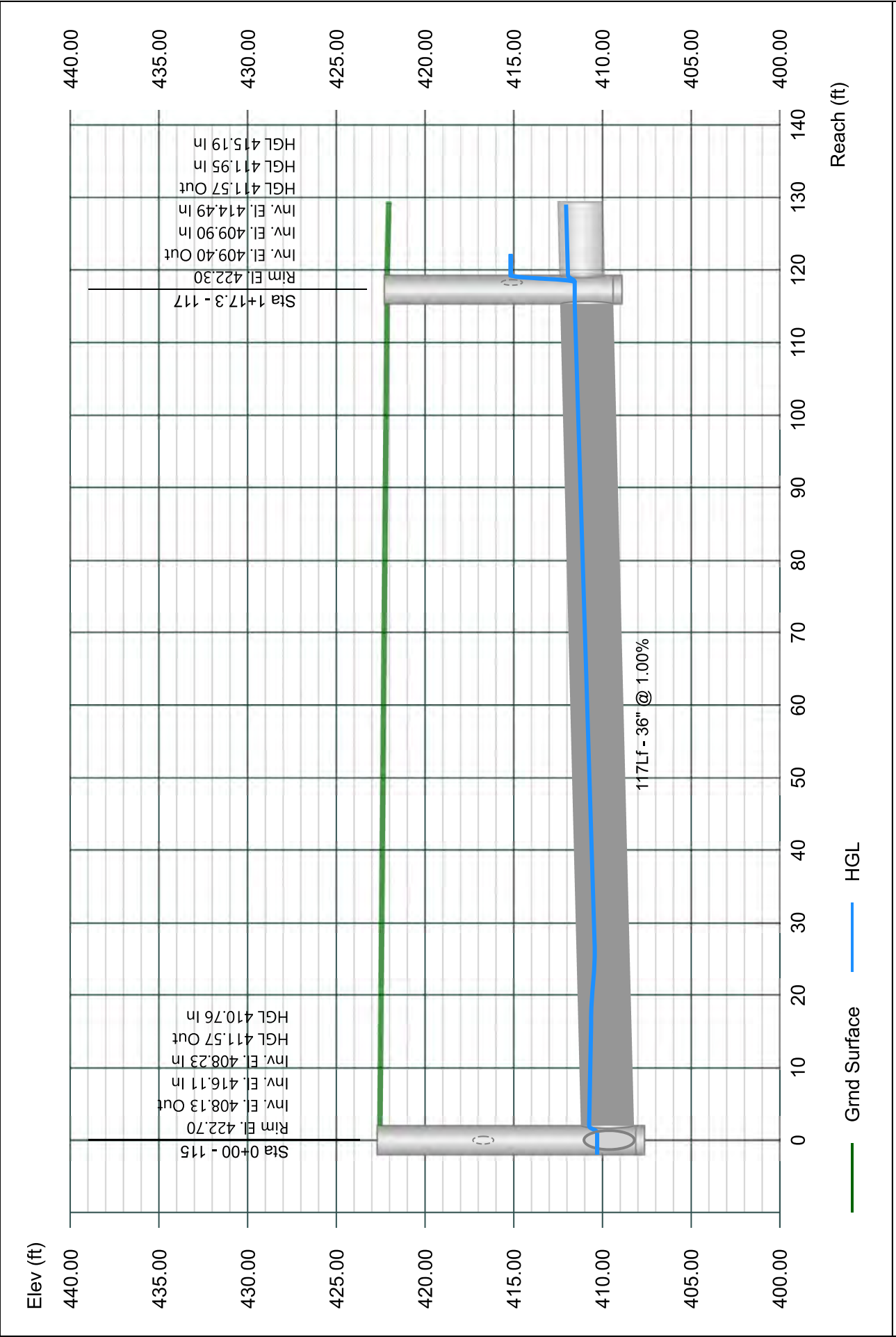

Line 18 - 118 TO 117

Stormwater Studio 2024 v 3.0.0.33

Project Name: Enter Project Name...

01-19-2024

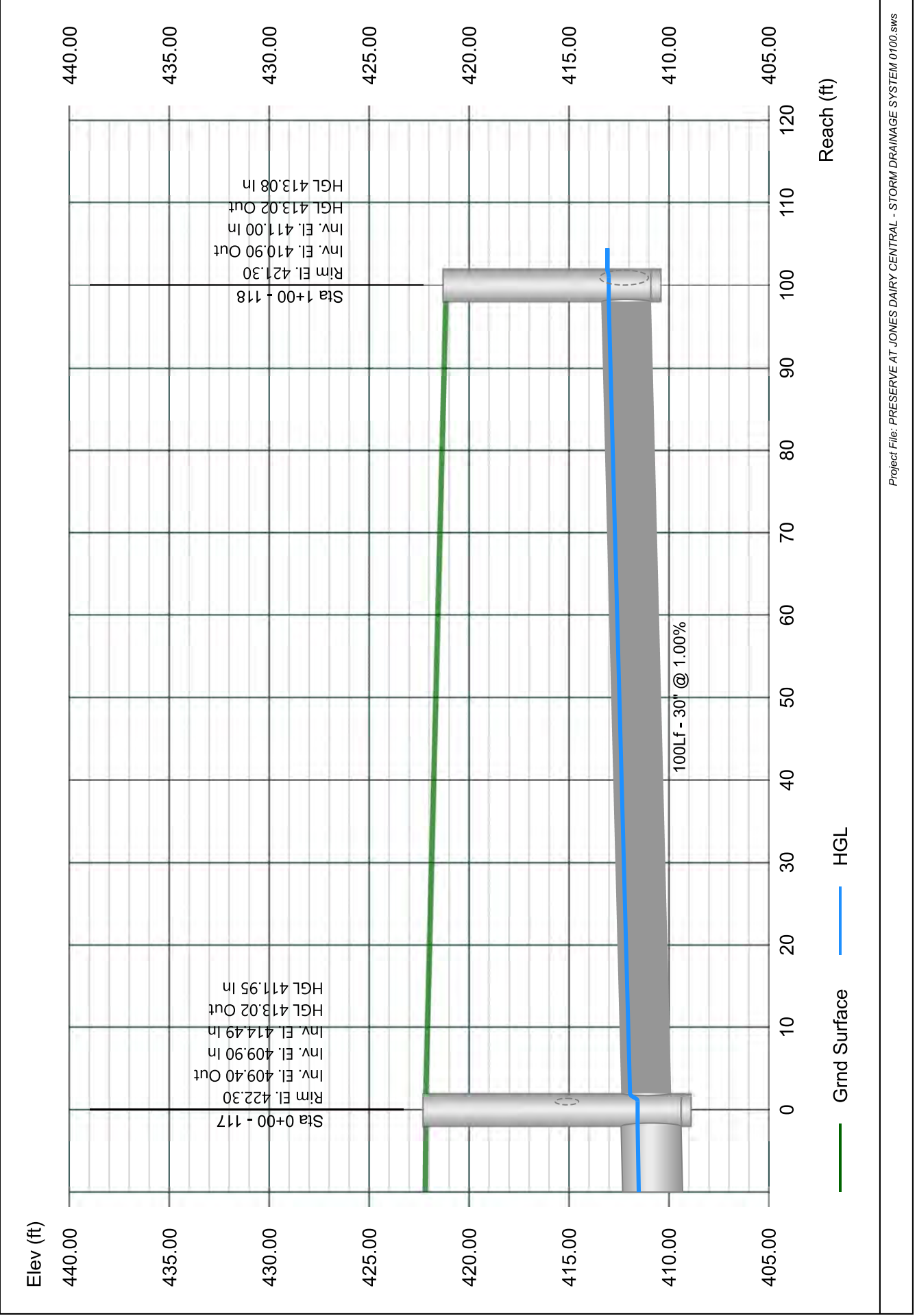

Line 19 - 119 TO 118

Stormwater Studio 2024 v 3.0.0.33

Project Name: Enter Project Name...

01-19-2024

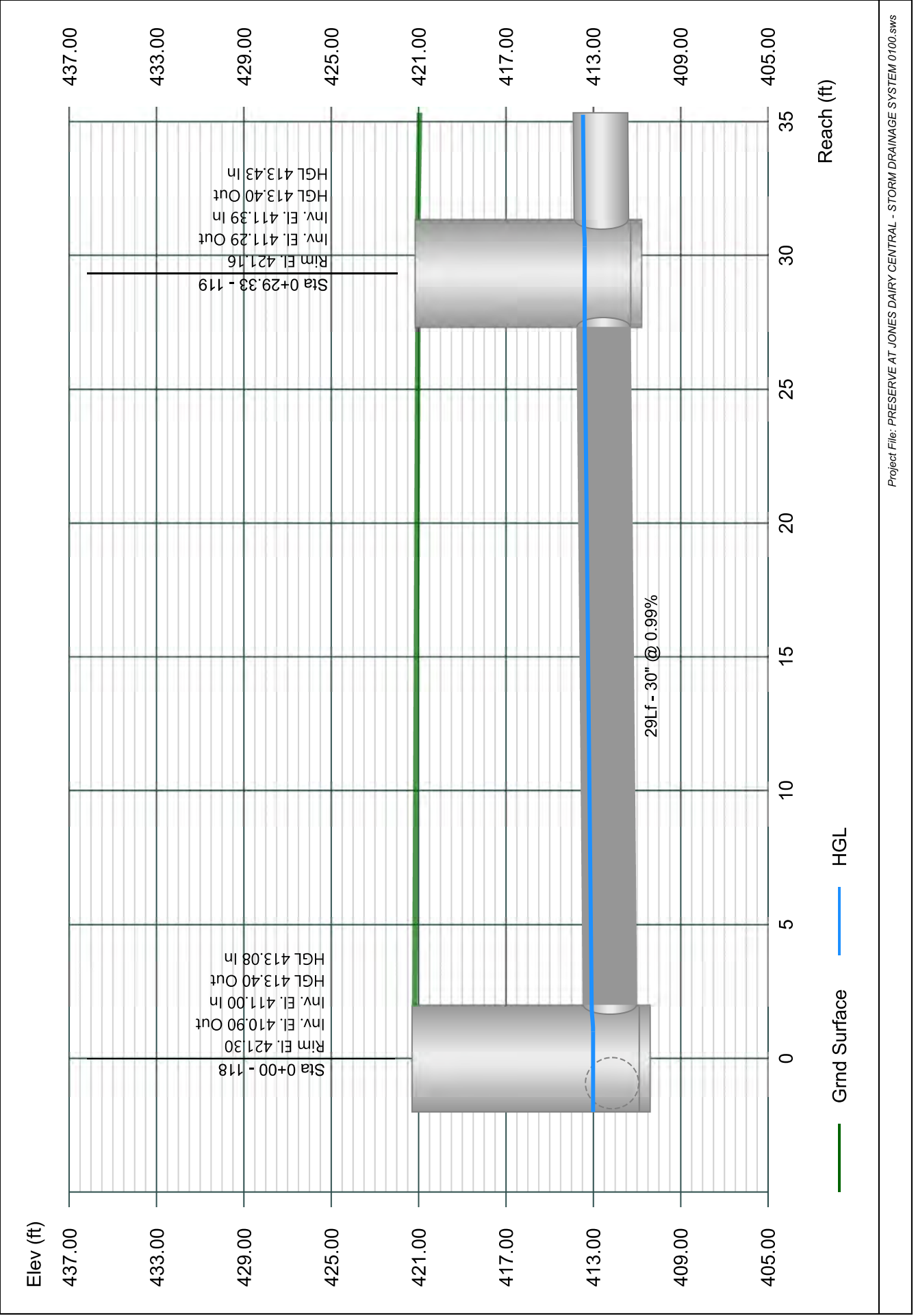

Line 20 - 120 TO 119

Stormwater Studio 2024 v 3.0.0.33

Project Name: Enter Project Name...

01-19-2024

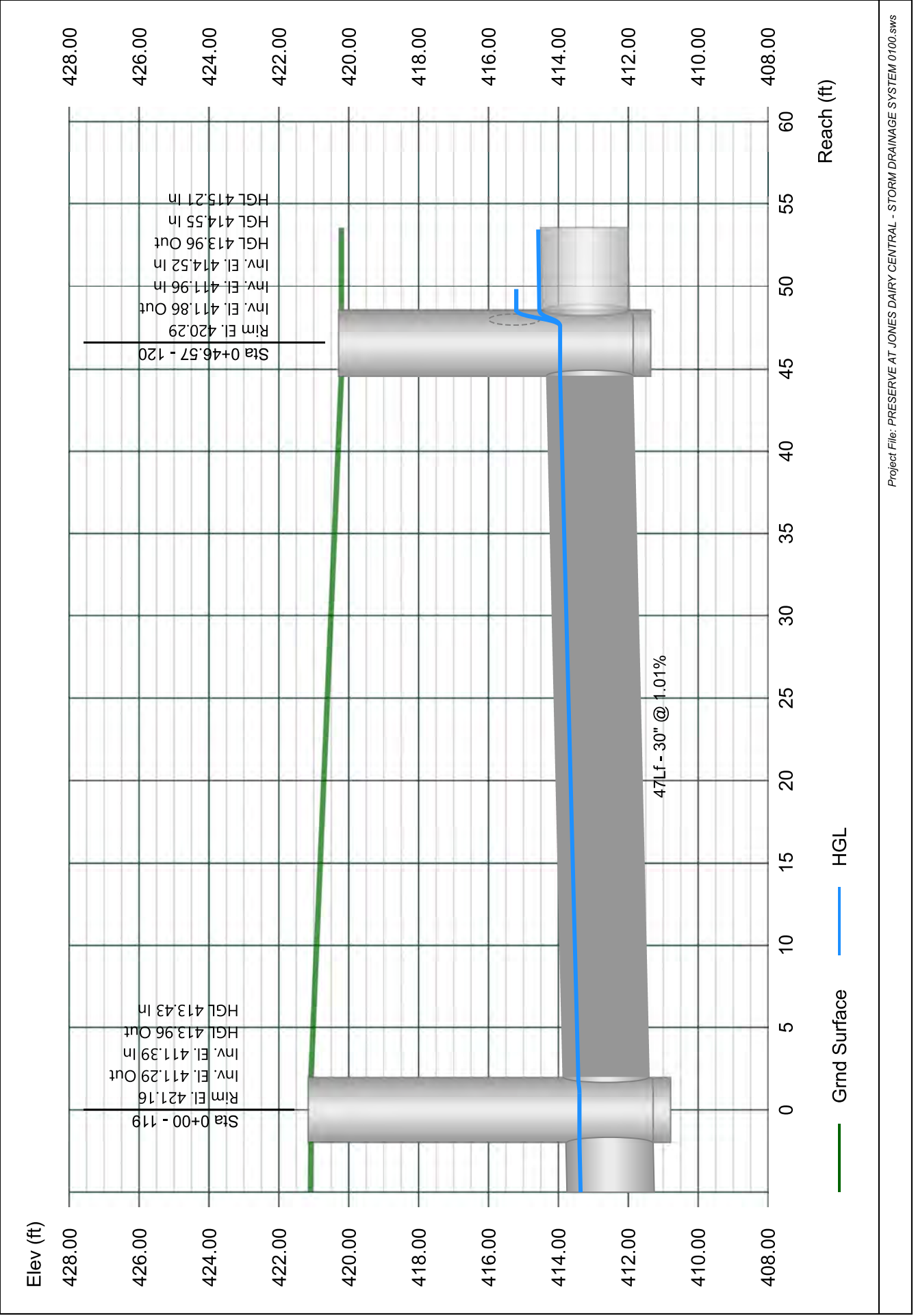

Line 21 - 121 TO 120

Stormwater Studio 2024 v 3.0.0.33

Project Name: Enter Project Name...

01-19-2024

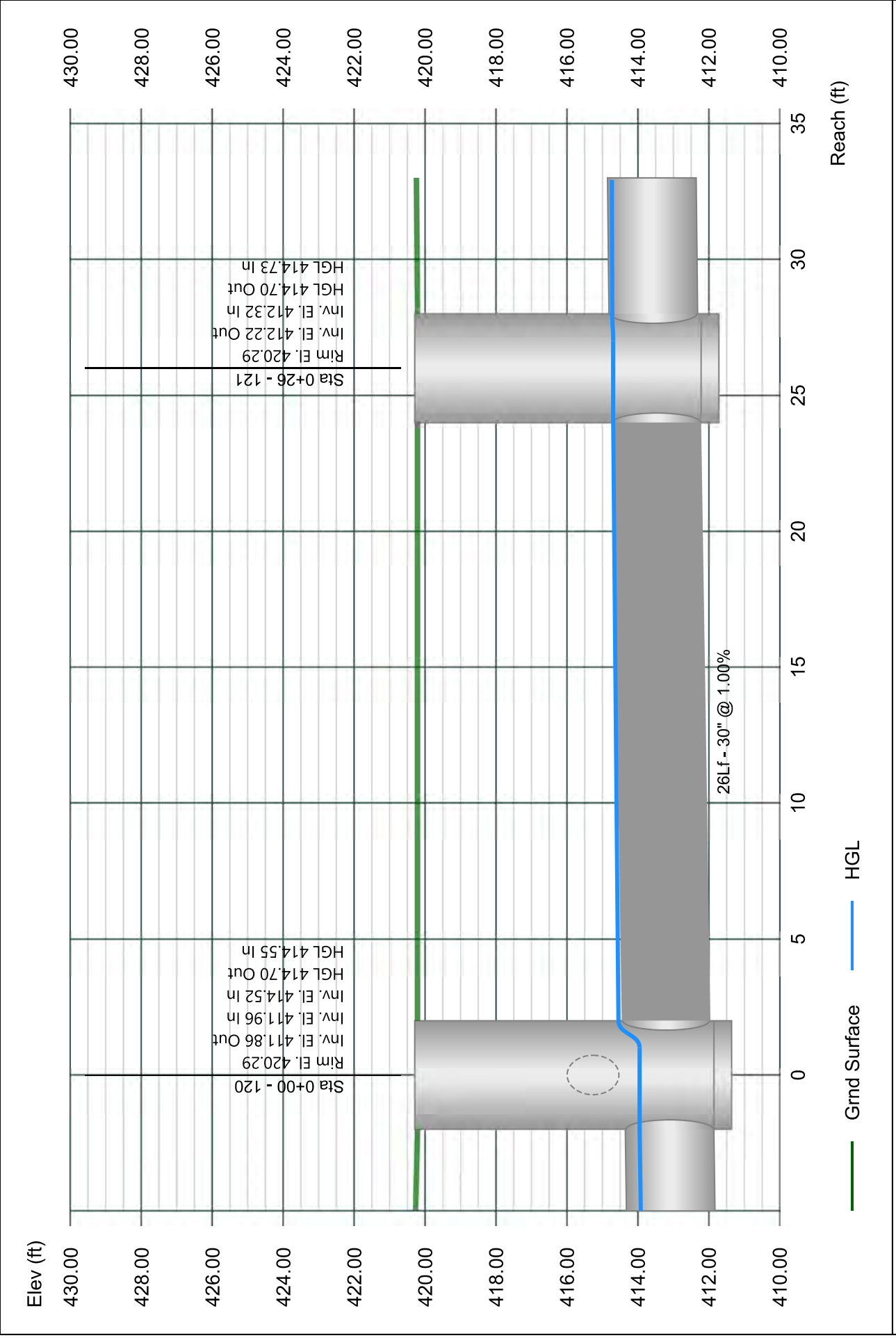

Line 22 - 122 TO 121

Stormwater Studio 2024 v 3.0.0.33

Project Name: Enter Project Name...

01-19-2024

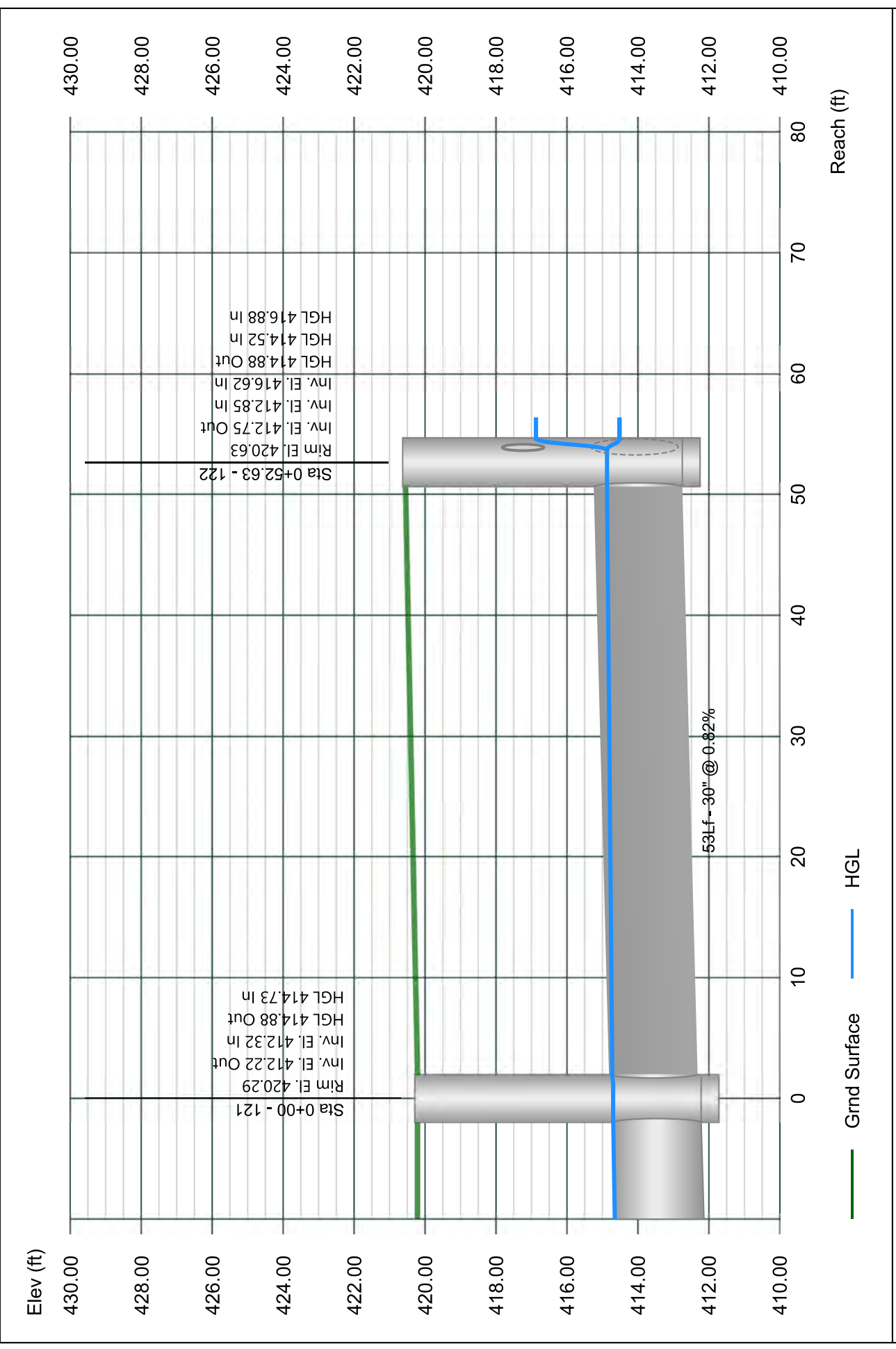

Line 23 - 123 TO 122

Stormwater Studio 2024 v 3.0.0.33

Project Name: Enter Project Name...

01-19-2024

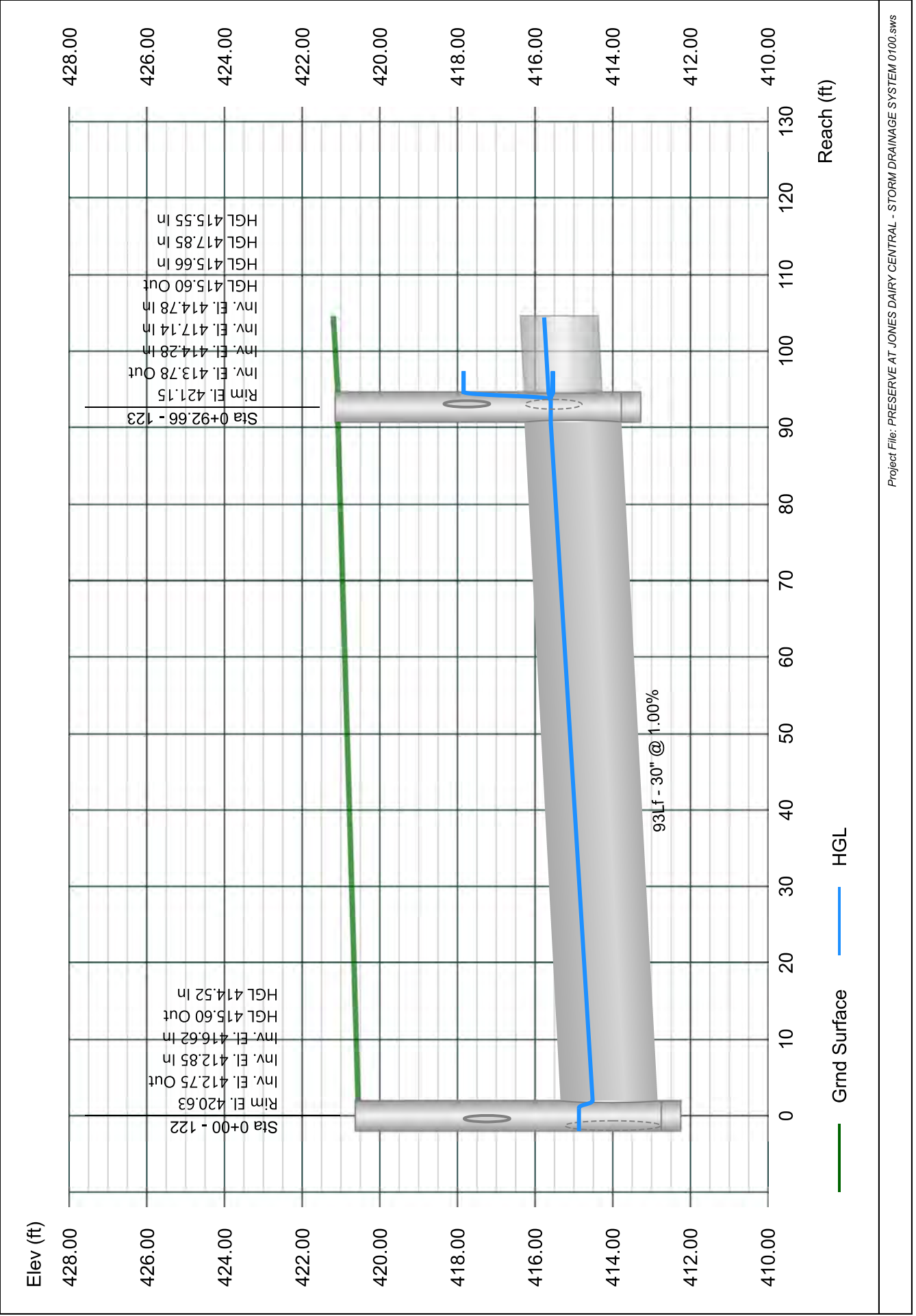

Line 24 - 124 TO 123

Stormwater Studio 2024 v 3.0.0.33

Project Name: Enter Project Name...

01-19-2024

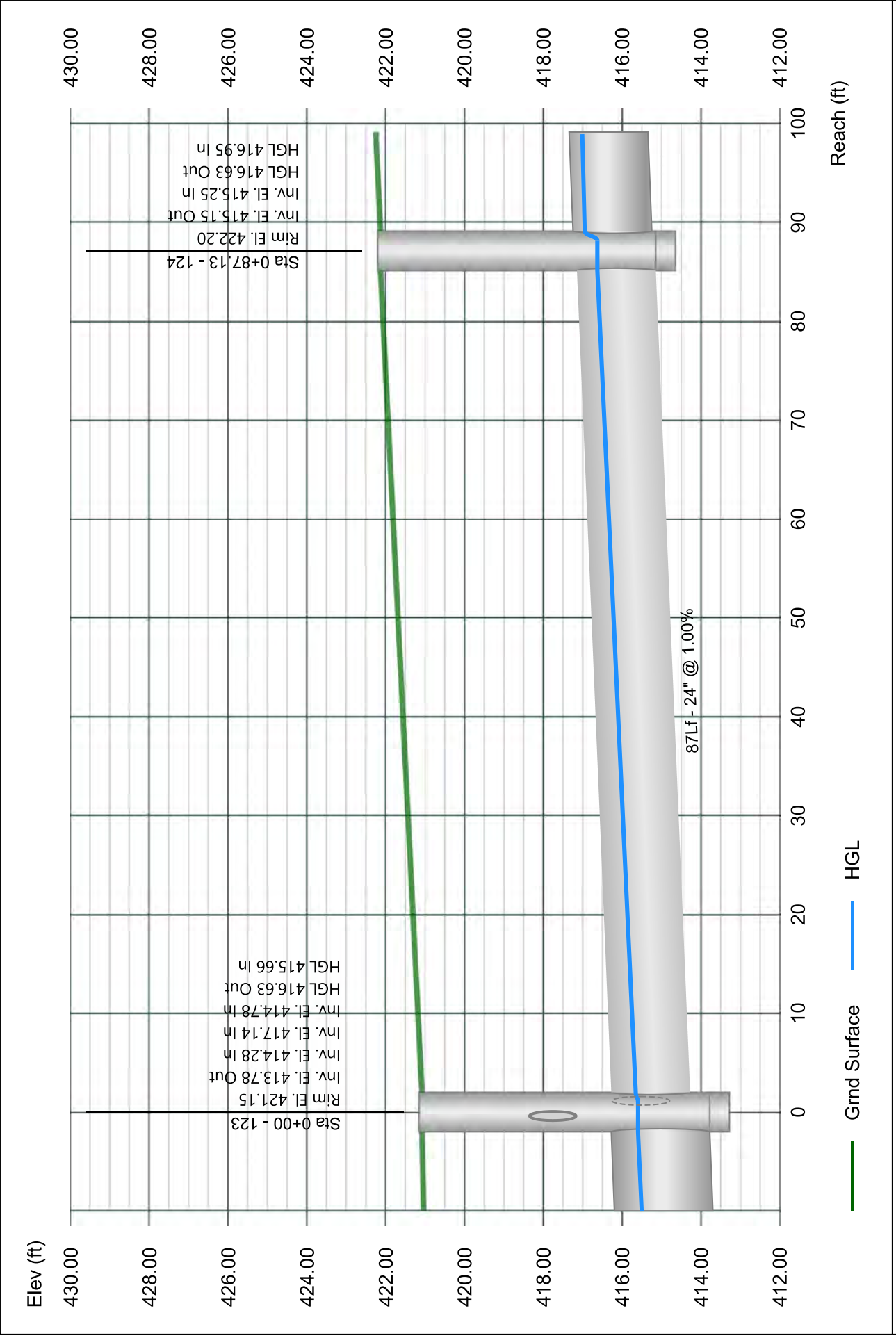

Line 25 - 125 TO 124

Stormwater Studio 2024 v 3.0.0.33

Project Name: Enter Project Name...

01-19-2024

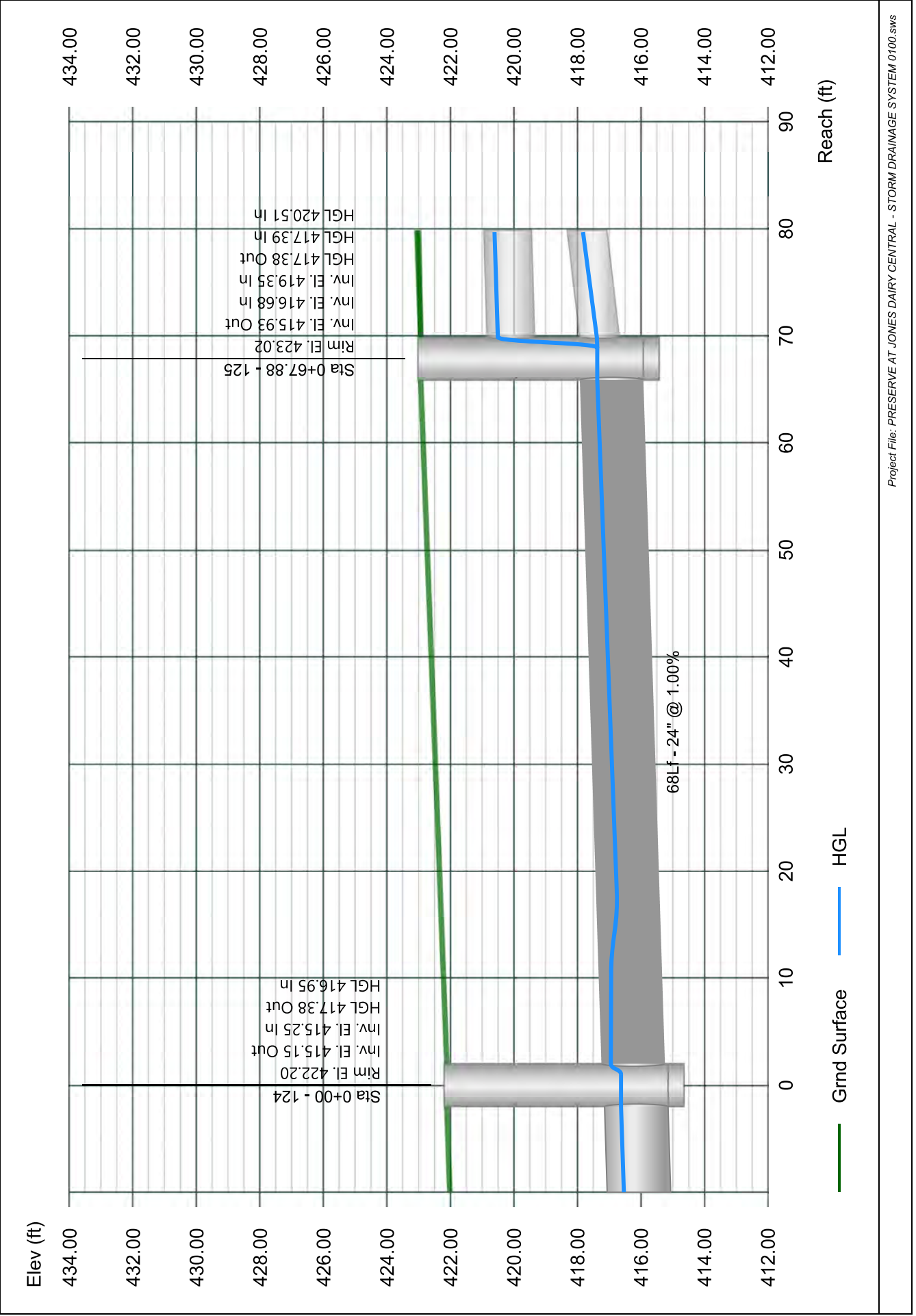

Line 26 - 126 TO 125

Stormwater Studio 2024 v 3.0.0.33

Project Name: Enter Project Name...

01-19-2024

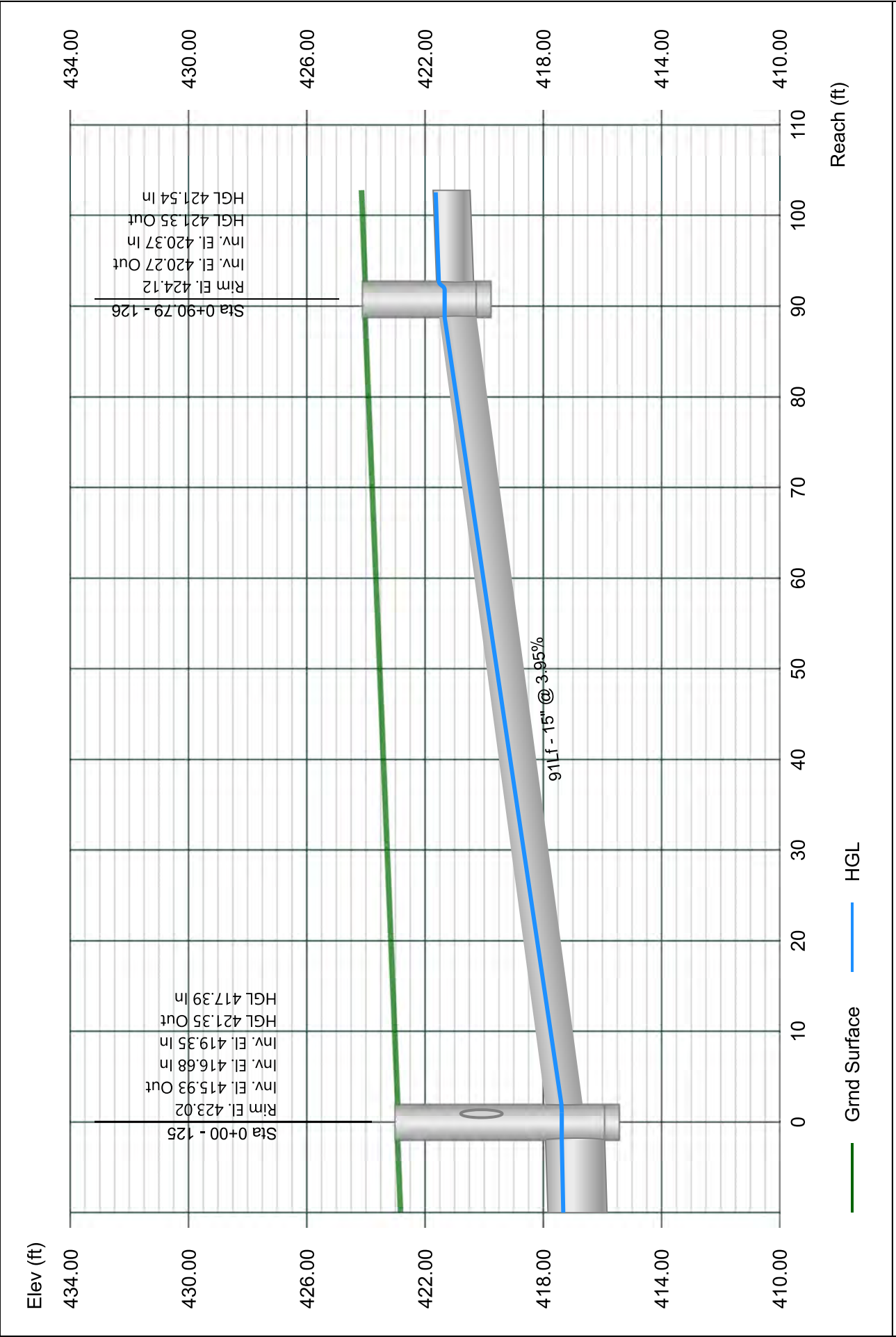

Line 27 - 127 TO 126

Stormwater Studio 2024 v 3.0.0.33

Project Name: Enter Project Name...

01-19-2024

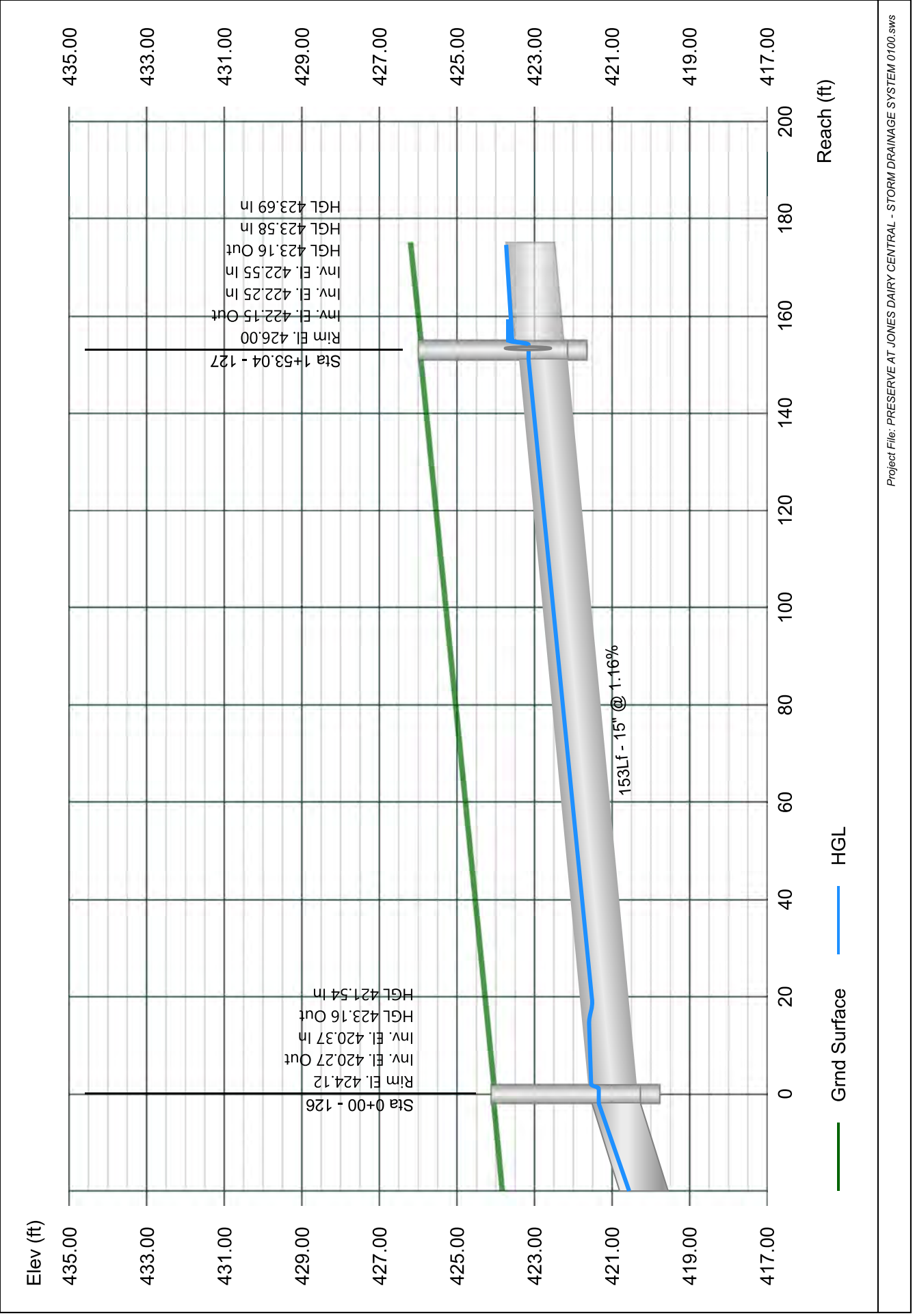

Line 28 - 128 TO 127

Stormwater Studio 2024 v 3.0.0.33

Project Name: Enter Project Name...

01-19-2024

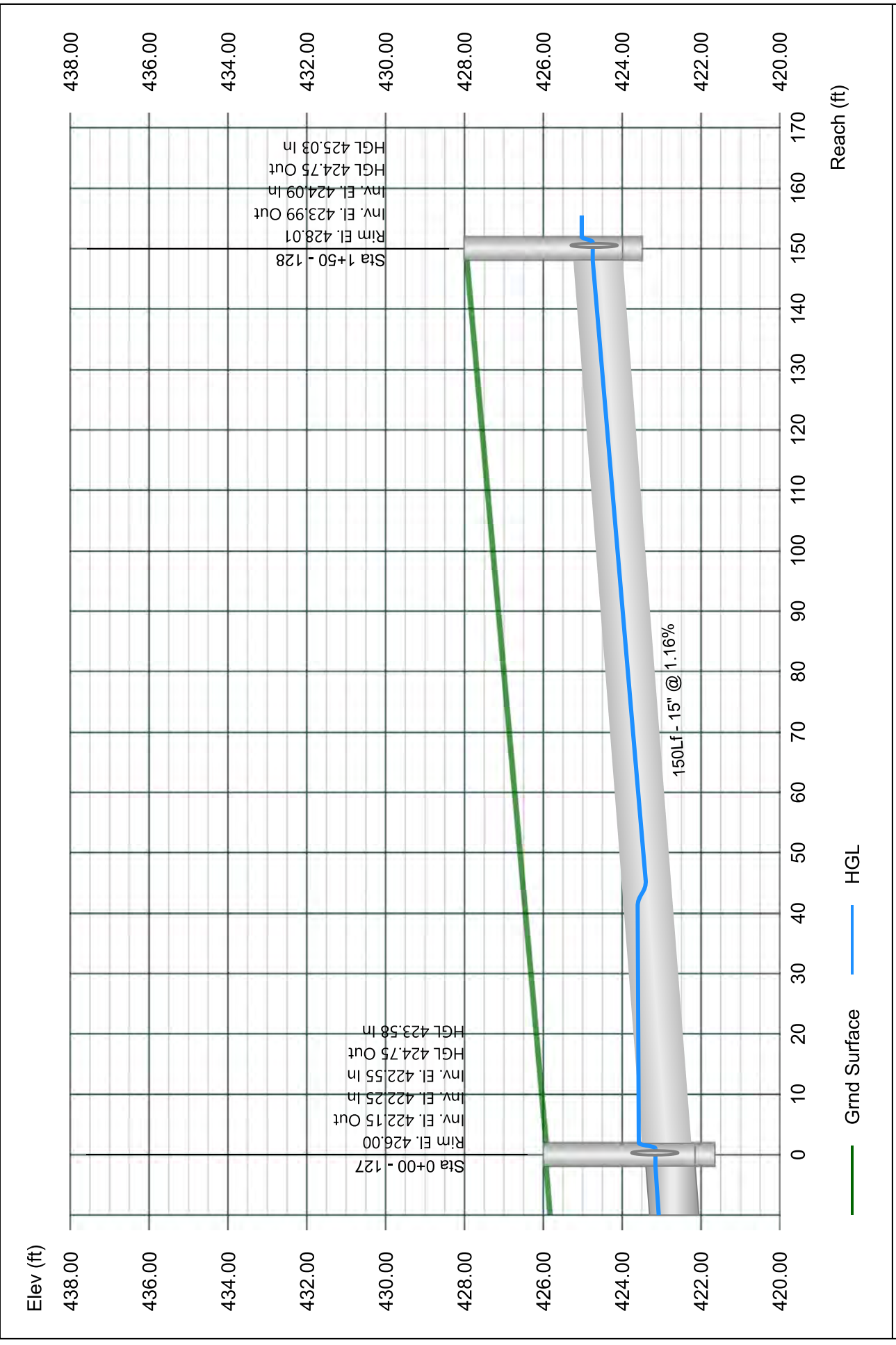

Line 29 - 129 TO 128

Stormwater Studio 2024 v 3.0.0.33

Project Name: Enter Project Name...

01-19-2024

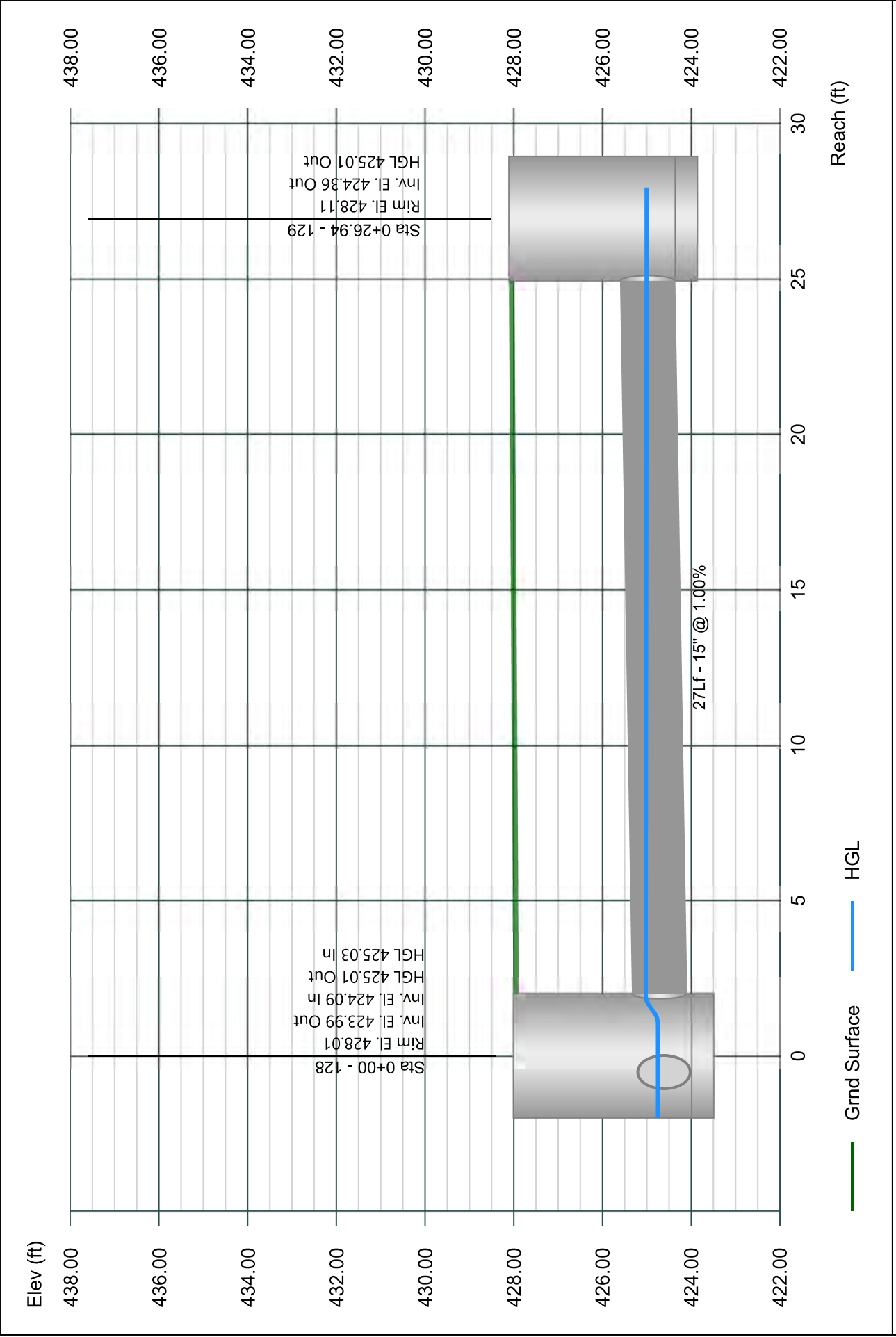

Line 30 - 130 TO 127

Stormwater Studio 2024 v 3.0.0.33

Project Name: Enter Project Name...

01-19-2024

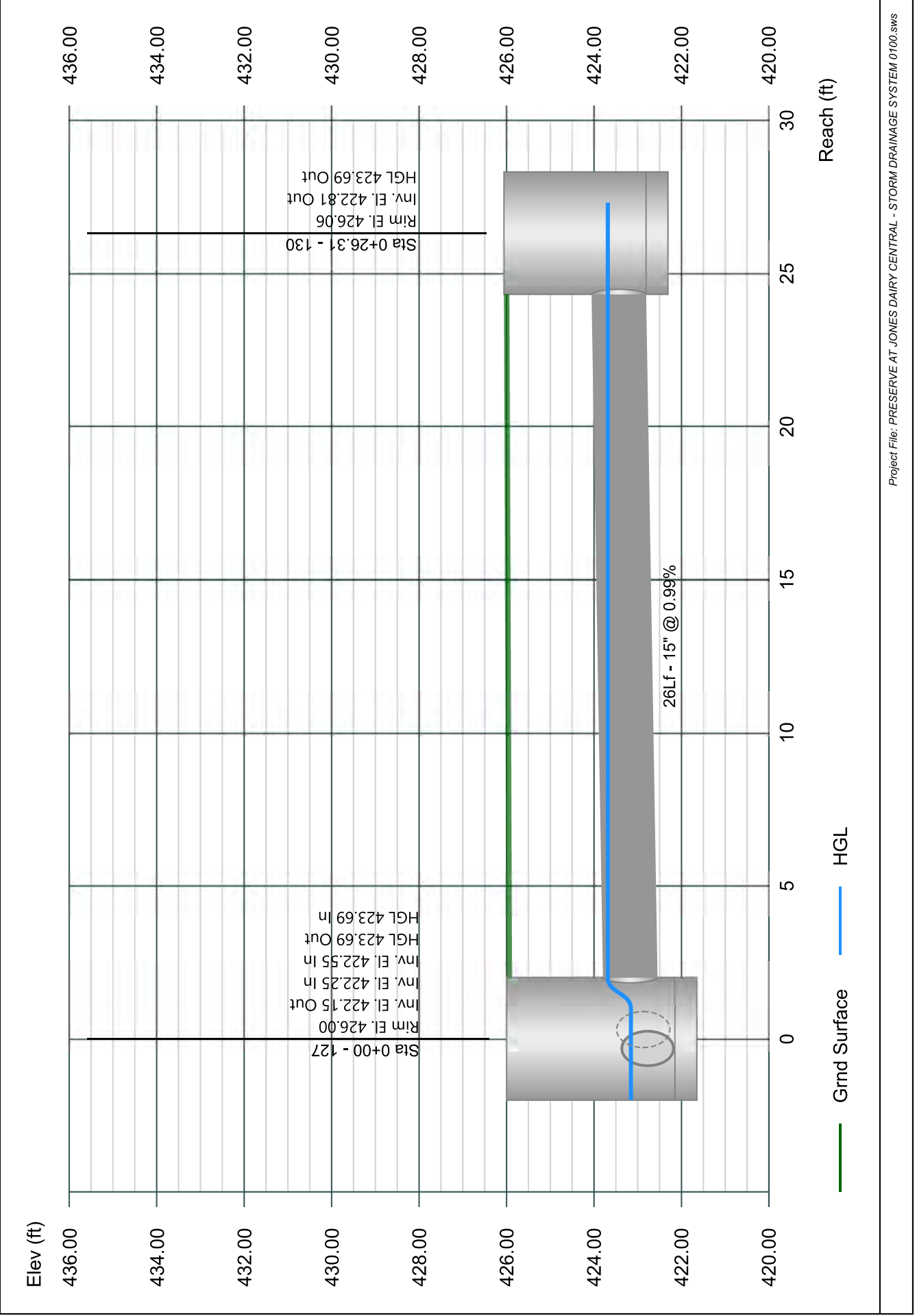

Line 31 - 131 TO 125

Stormwater Studio 2024 v 3.0.0.33

Project Name: Enter Project Name...

01-19-2024

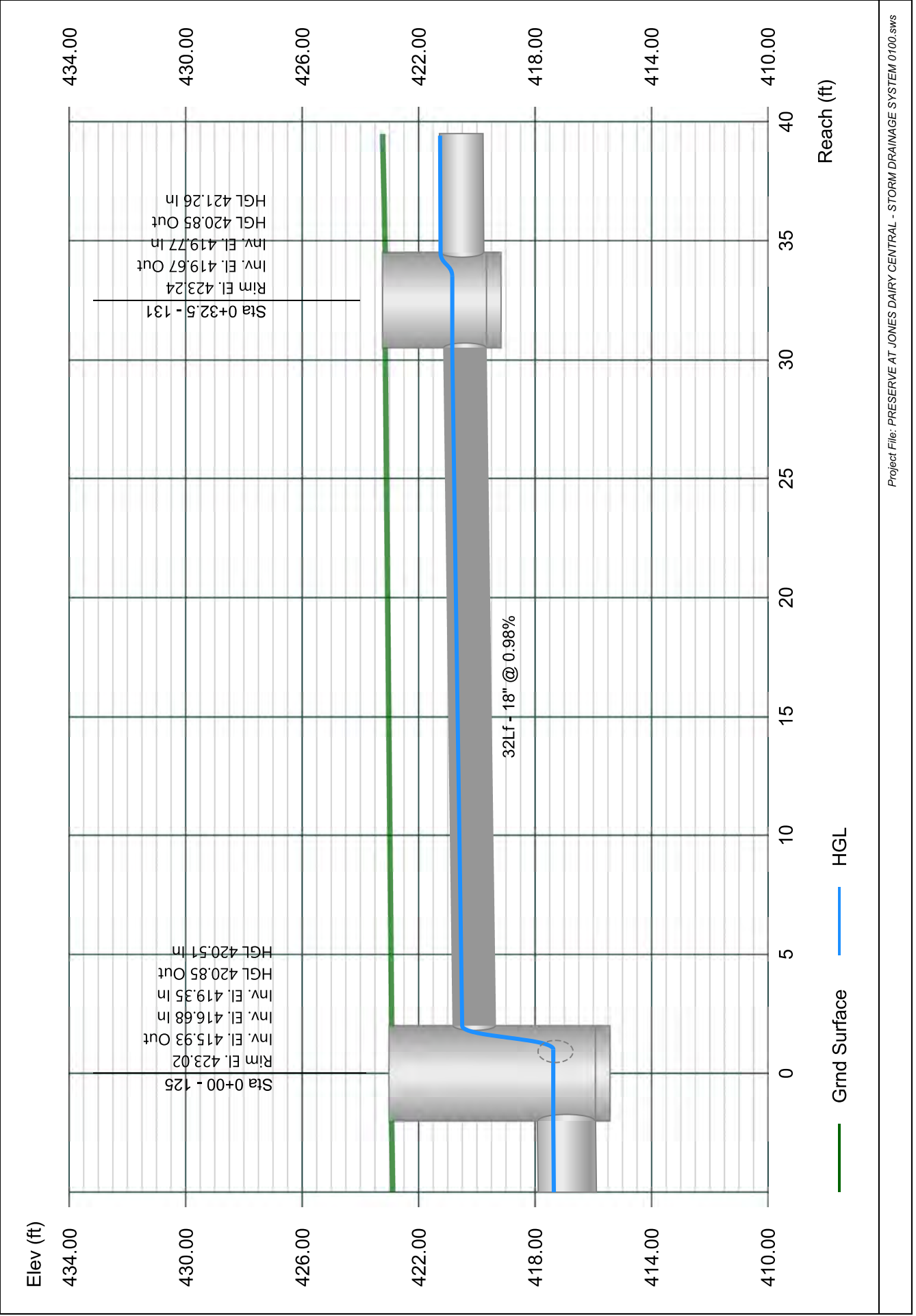

Line 32 - 132 TO 131

Stormwater Studio 2024 v 3.0.0.33

Project Name: Enter Project Name...

01-19-2024

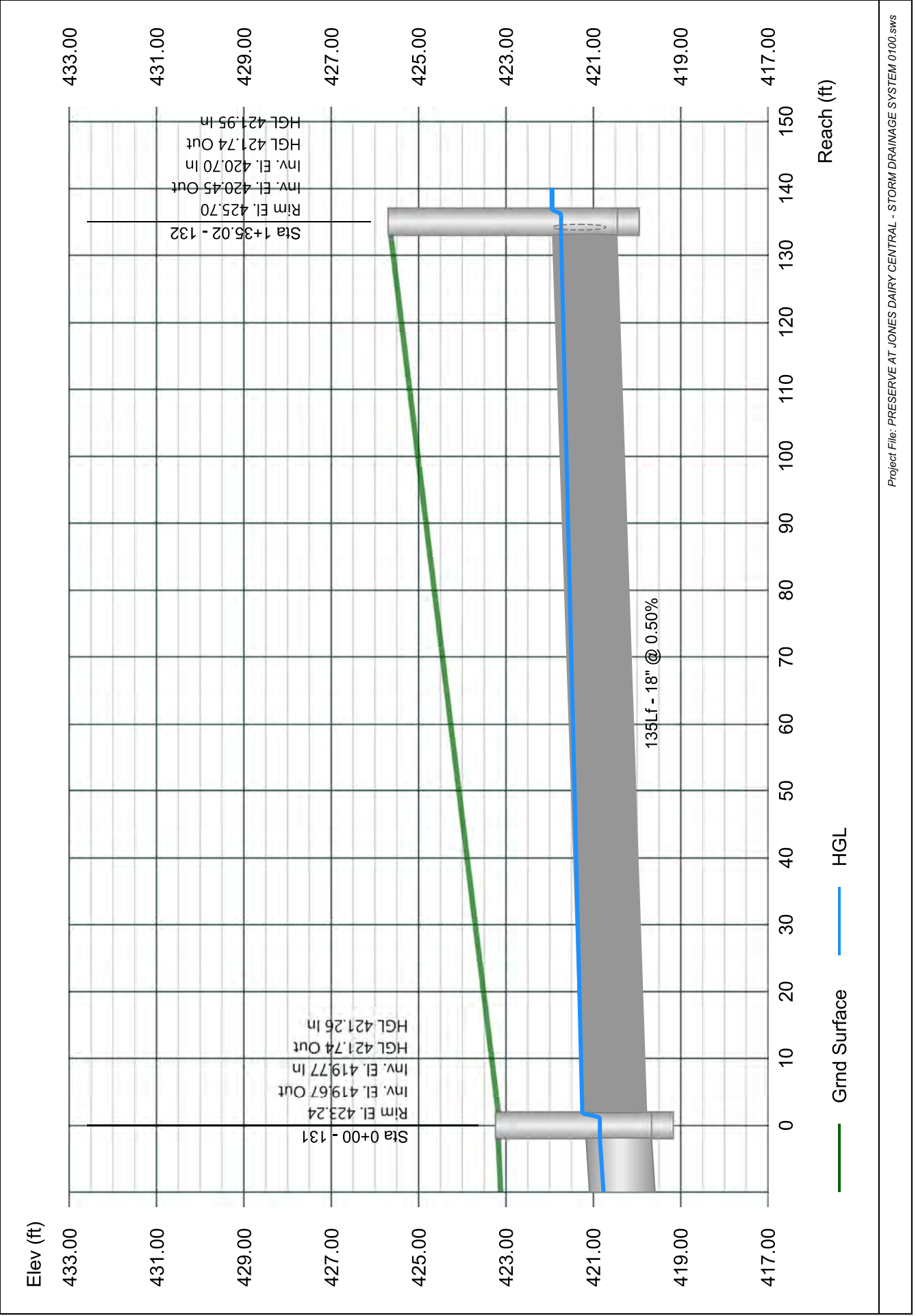

Line 33 - 133 TO 132

Stormwater Studio 2024 v 3.0.0.33

Project Name: Enter Project Name...

01-19-2024

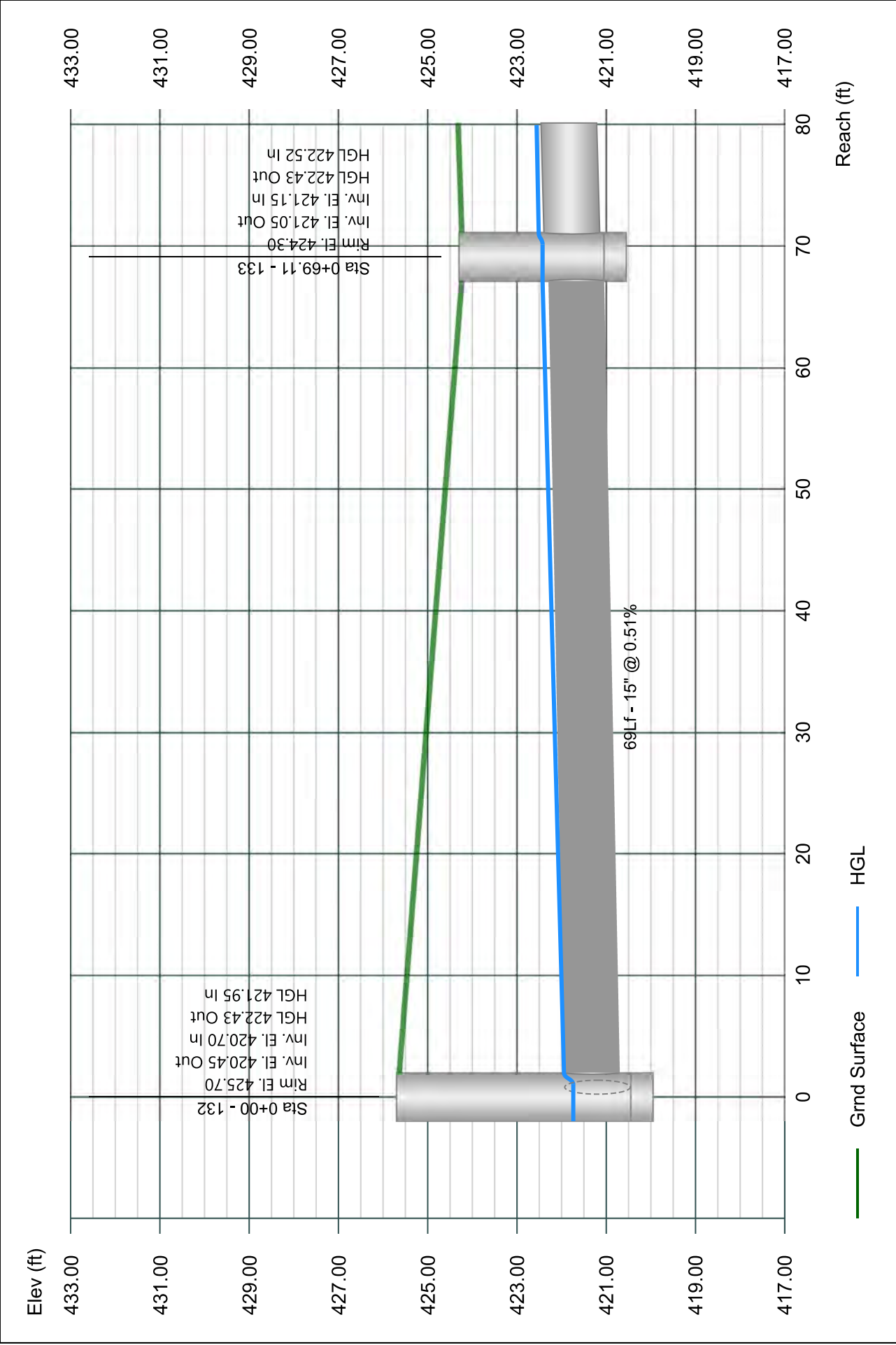

Line 34 - 134 TO 133

Stormwater Studio 2024 v 3.0.0.33

Project Name: Enter Project Name...

01-19-2024

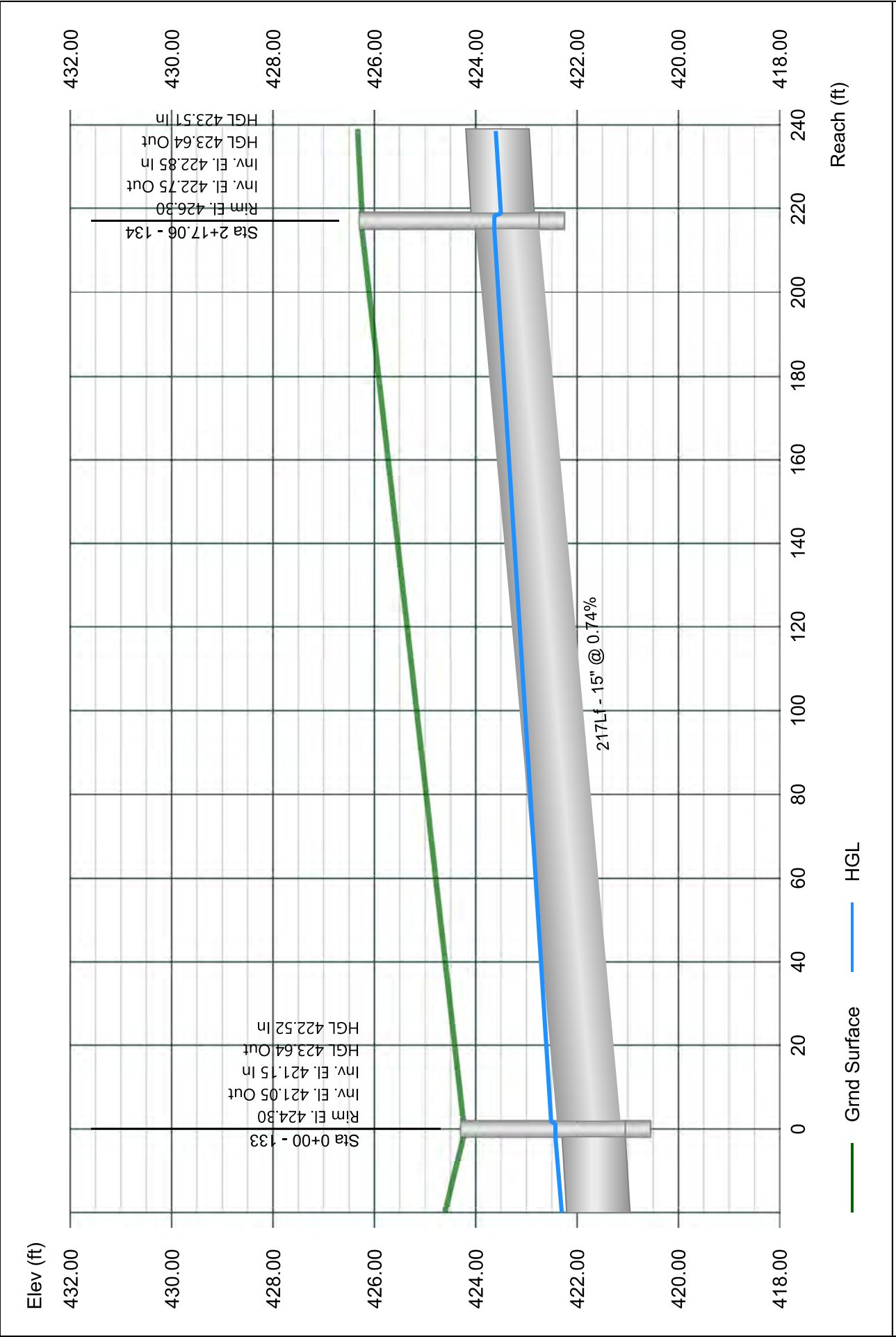

Line 35 - 135 TO 134

Stormwater Studio 2024 v 3.0.0.33

Project Name: Enter Project Name...

01-19-2024

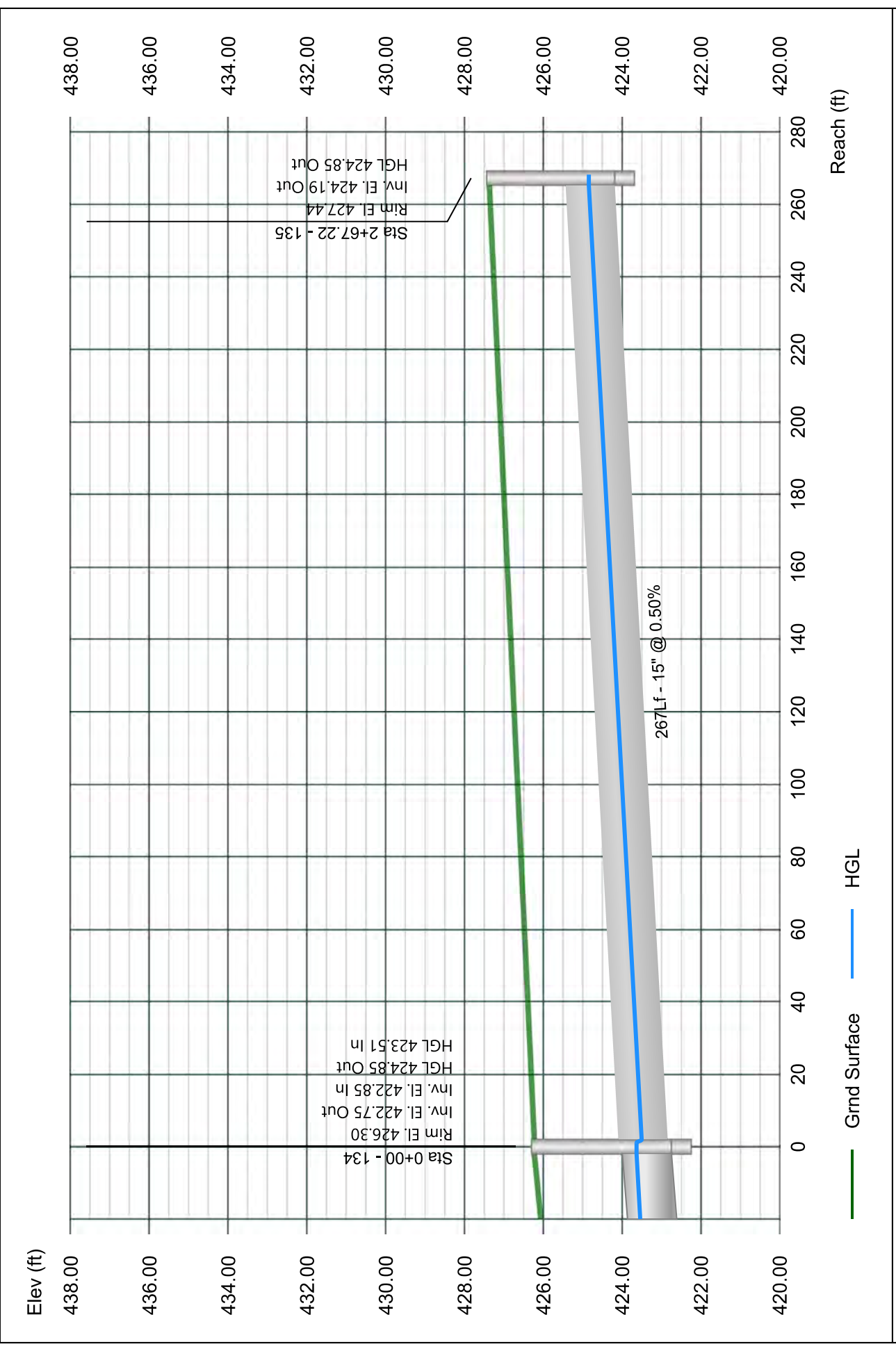

Line 36 - 136 TO 123

Stormwater Studio 2024 v 3.0.0.33

Project Name: Enter Project Name...

01-19-2024

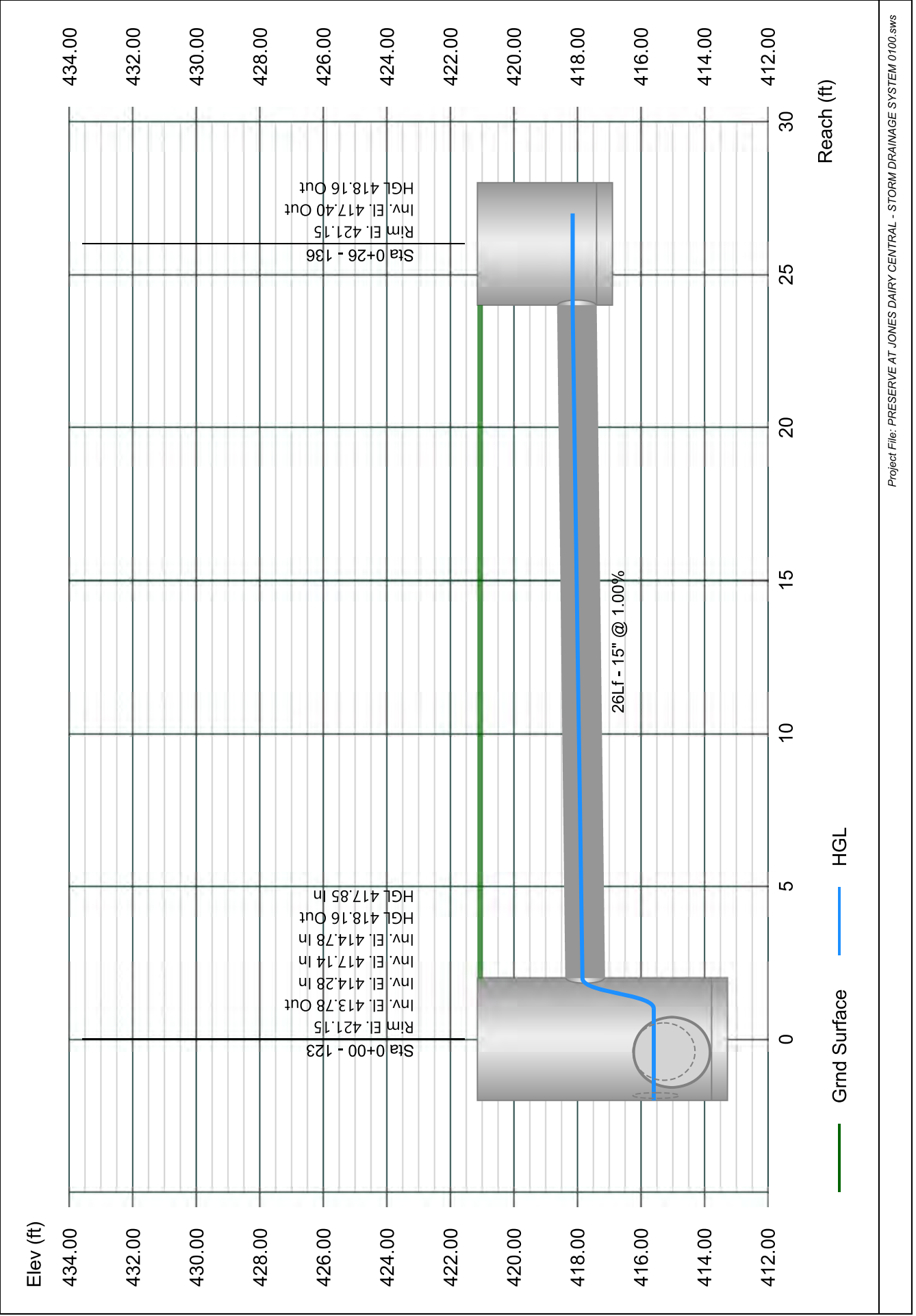

Line 37 - 137 TO 123

Stormwater Studio 2024 v 3.0.0.33

Project Name: Enter Project Name...

01-19-2024

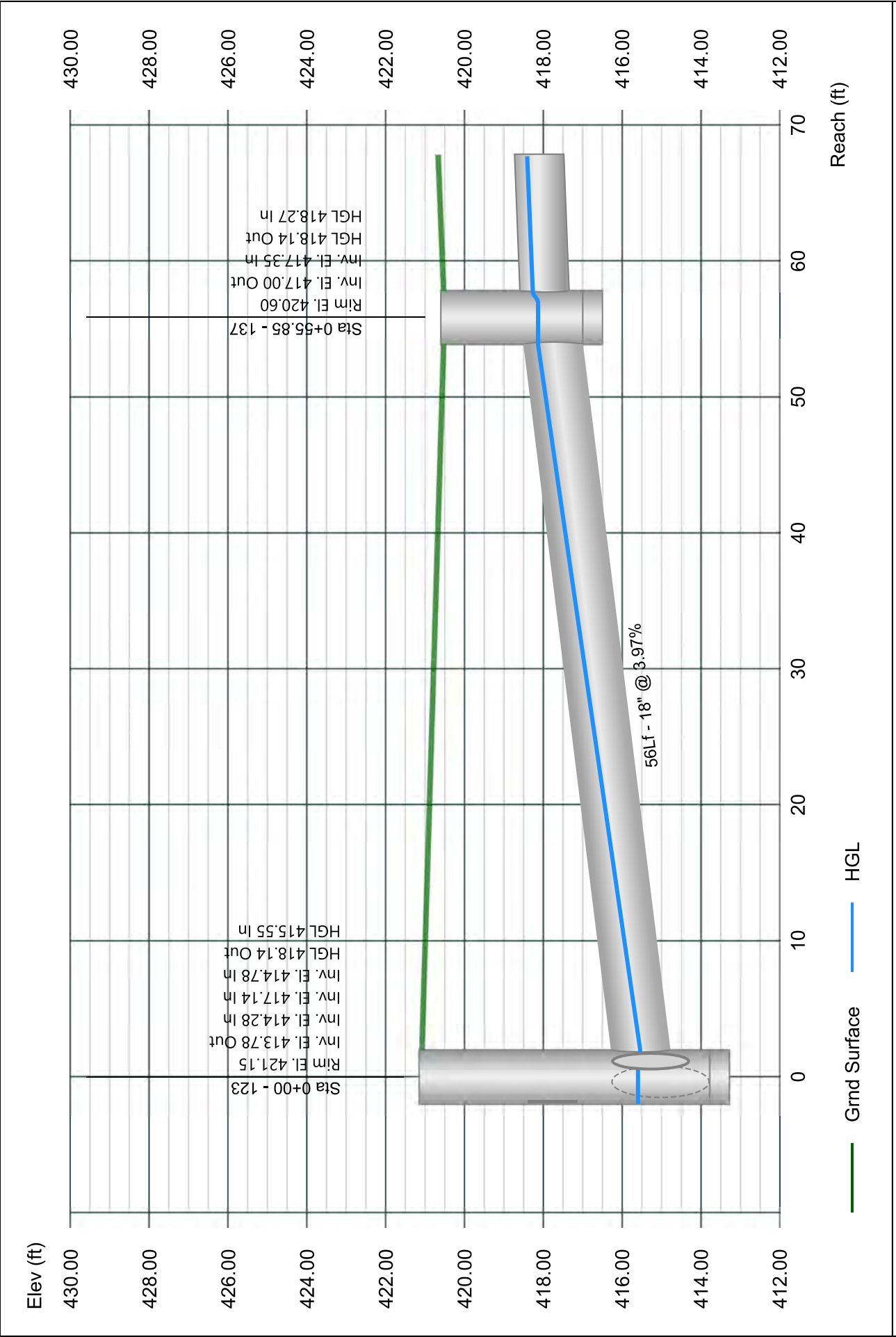

Line 38 - 138 TO 137

Stormwater Studio 2024 v 3.0.0.33

Project Name: Enter Project Name...

01-19-2024

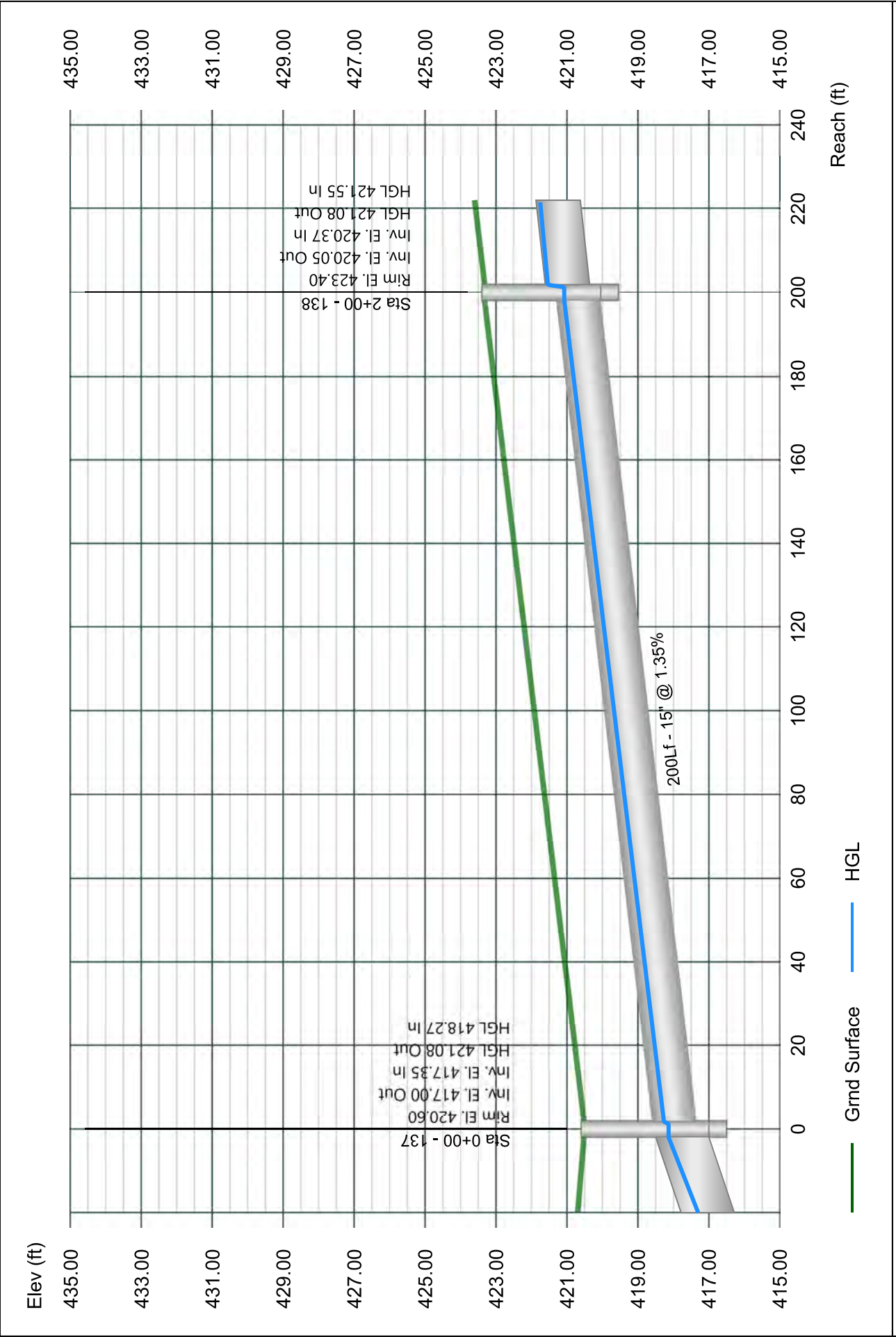

Line 39 - 139 TO 138

Stormwater Studio 2024 v 3.0.0.33

Project Name: Enter Project Name...

01-19-2024

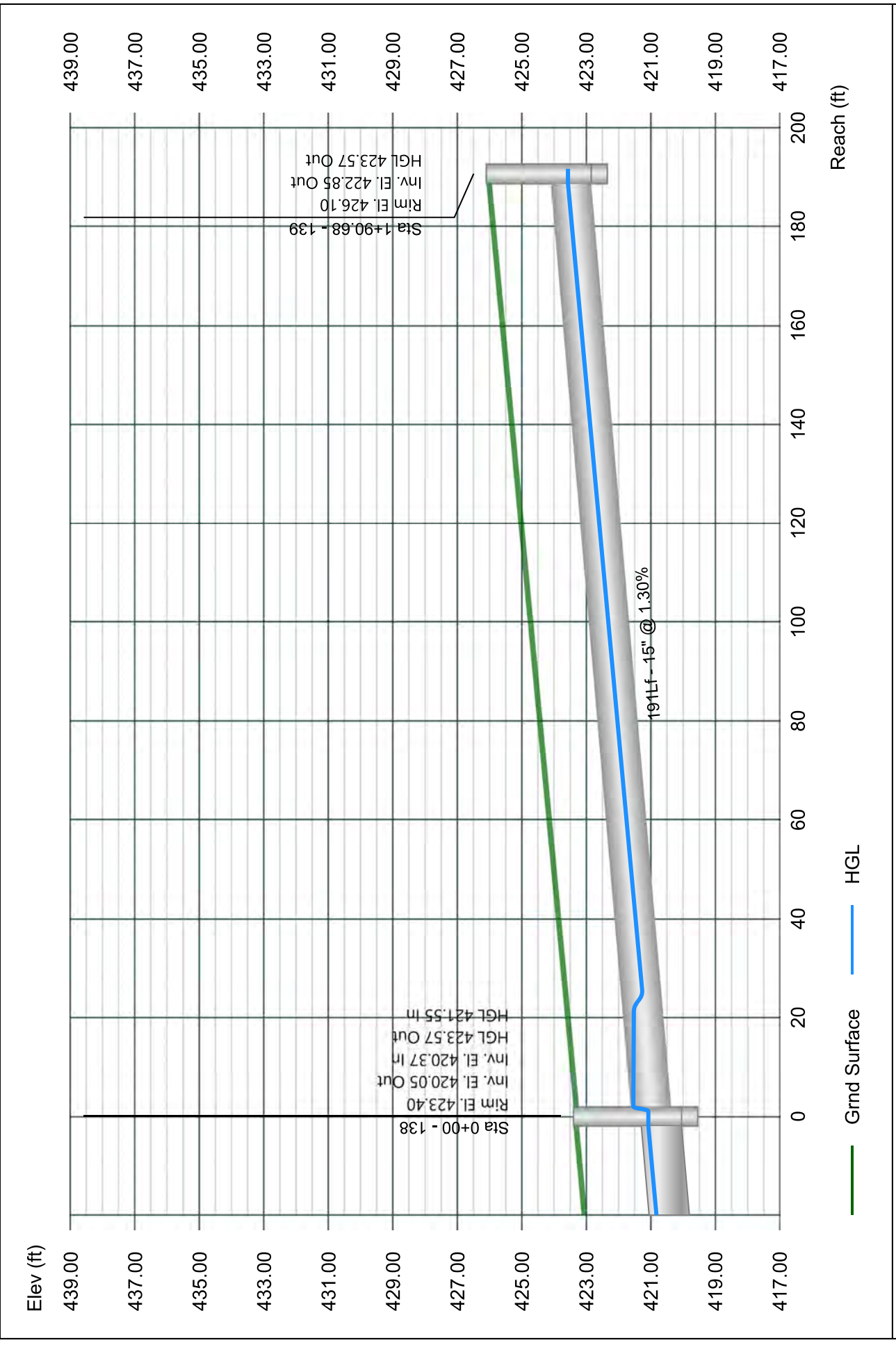

Line 40 - 140 TO 122

Stormwater Studio 2024 v 3.0.0.33

Project Name: Enter Project Name...

01-19-2024

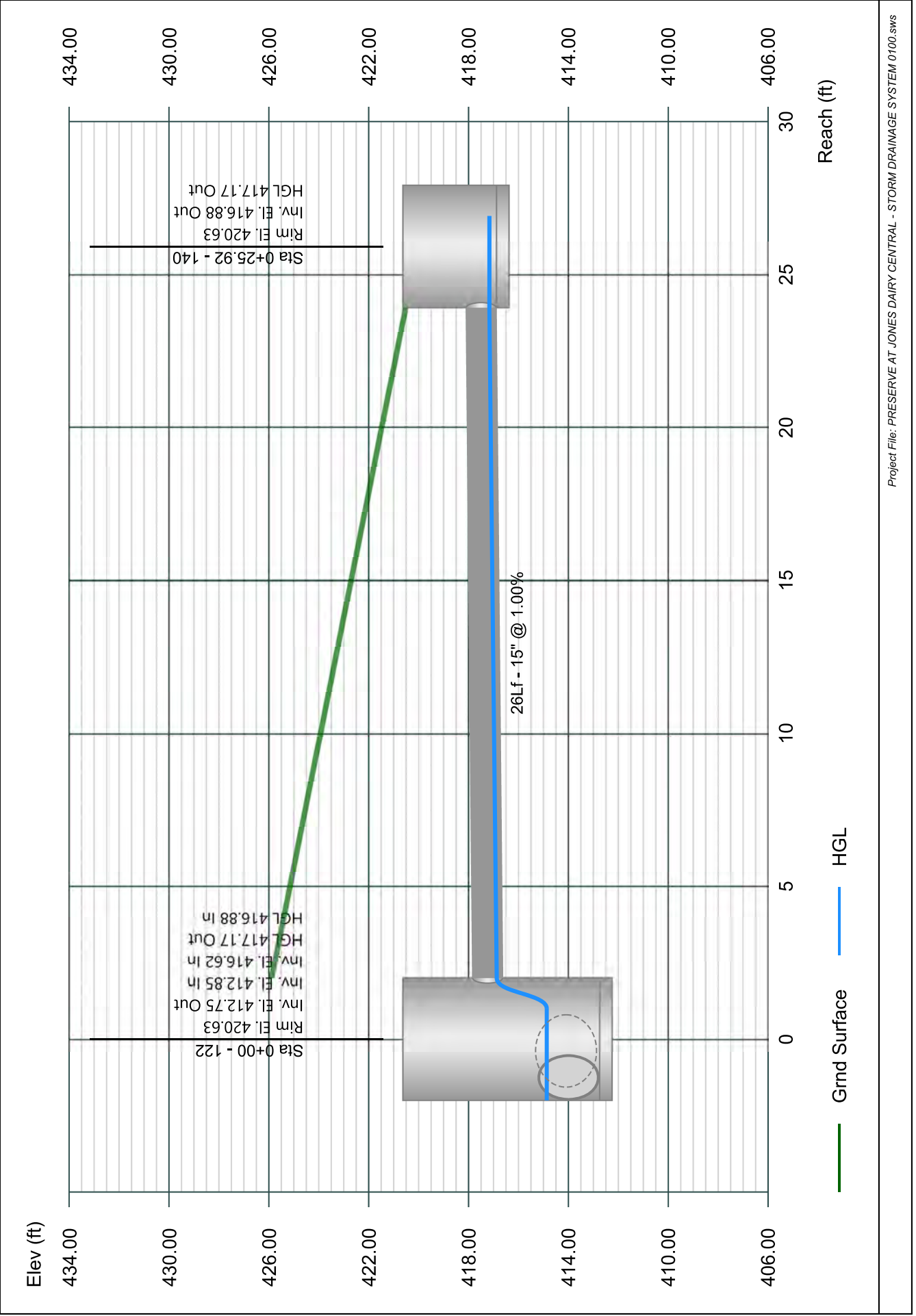

Line 41 - 141 TO 120

Stormwater Studio 2024 v 3.0.0.33

Project Name: Enter Project Name...

01-19-2024

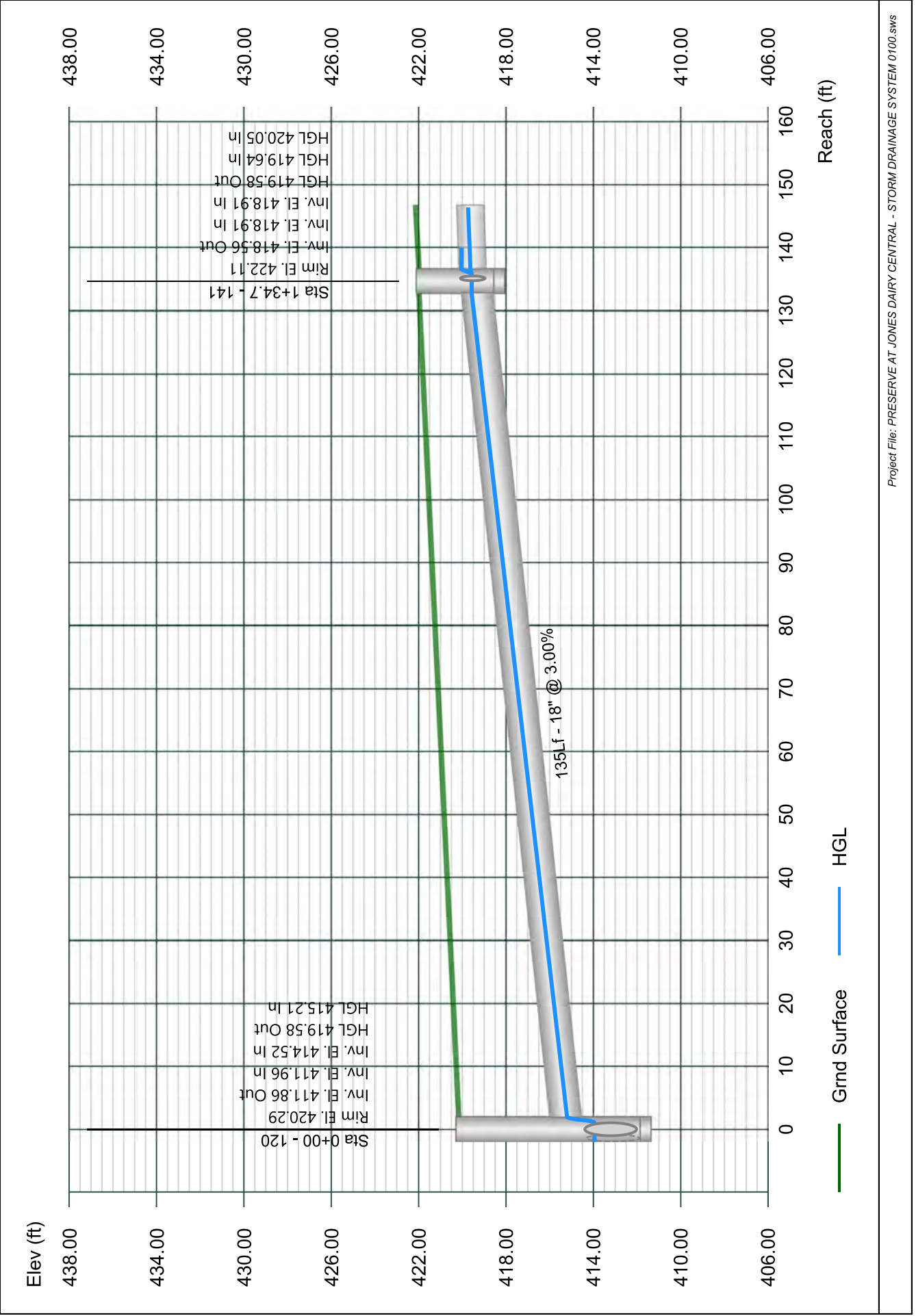

Line 42 - 142 TO 141

Stormwater Studio 2024 v 3.0.0.33

Project Name: Enter Project Name...

01-19-2024

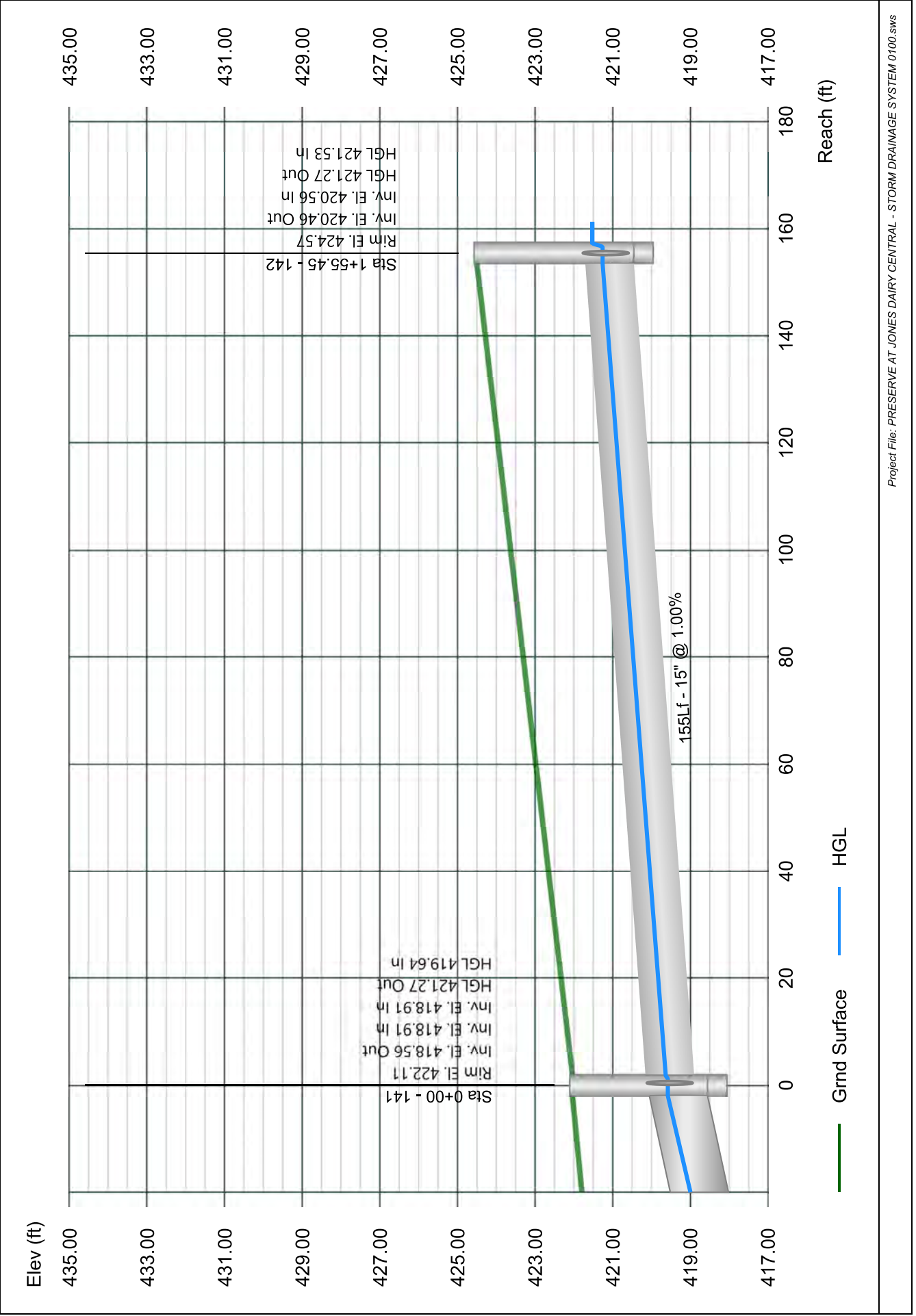

Line 43 - 143 TO 142

Stormwater Studio 2024 v 3.0.0.33

Project Name: Enter Project Name...

01-19-2024

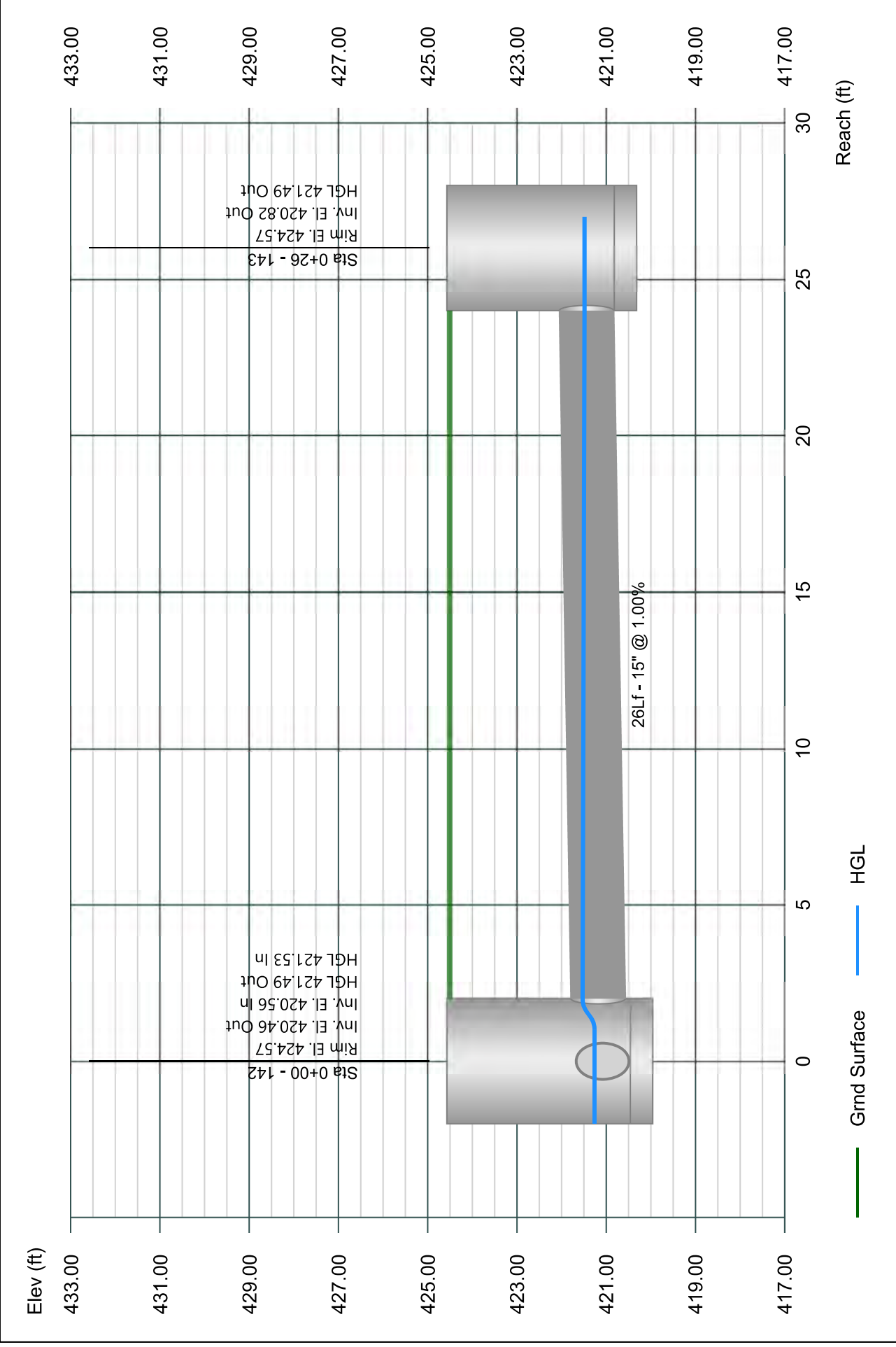

Line 44 - 144 TO 141

Stormwater Studio 2024 v 3.0.0.33

Project Name: Enter Project Name...

01-19-2024

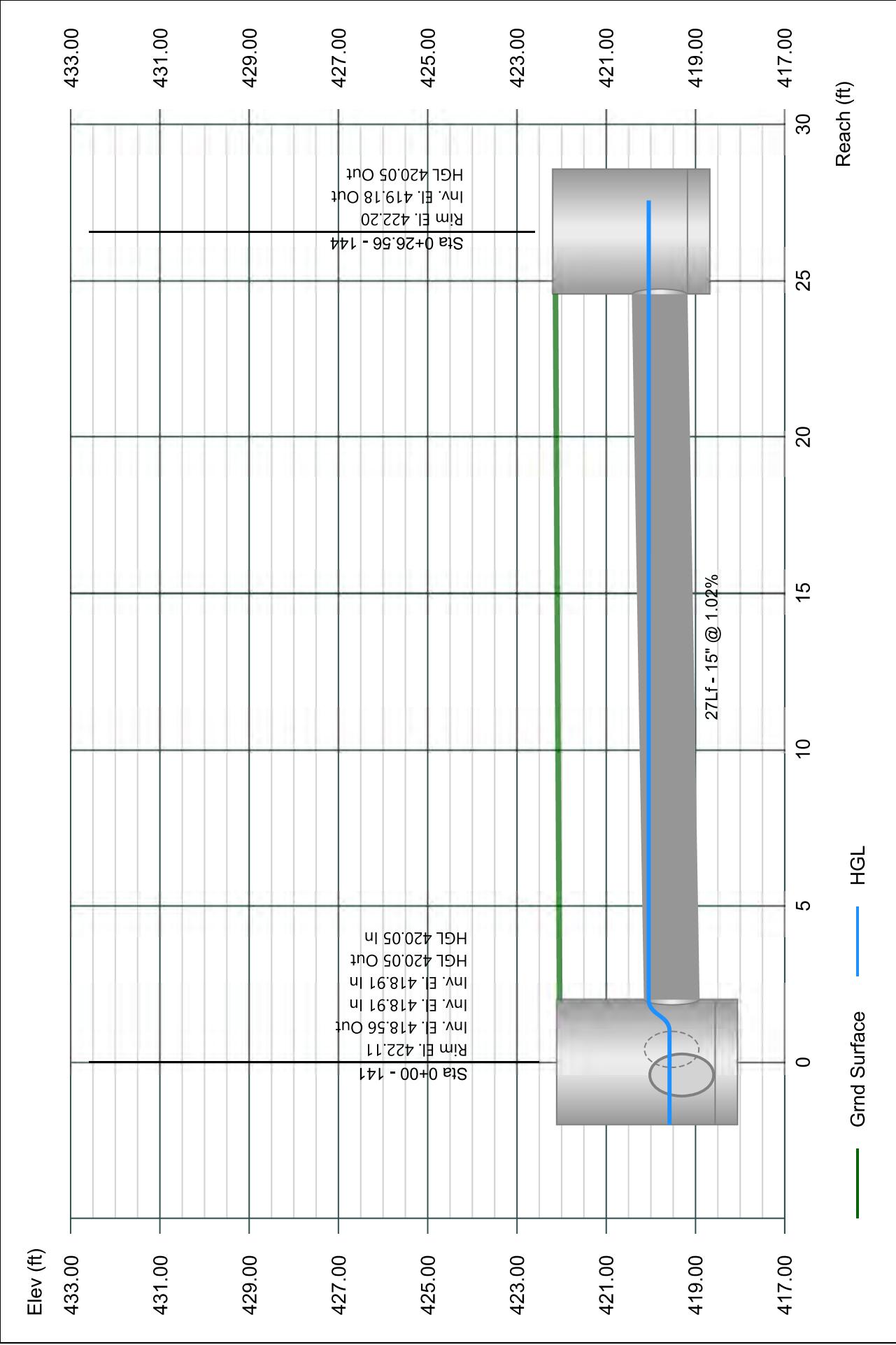

Line 45 - 145 to 117

Stormwater Studio 2024 v 3.0.0.33

Project Name: Enter Project Name...

01-19-2024

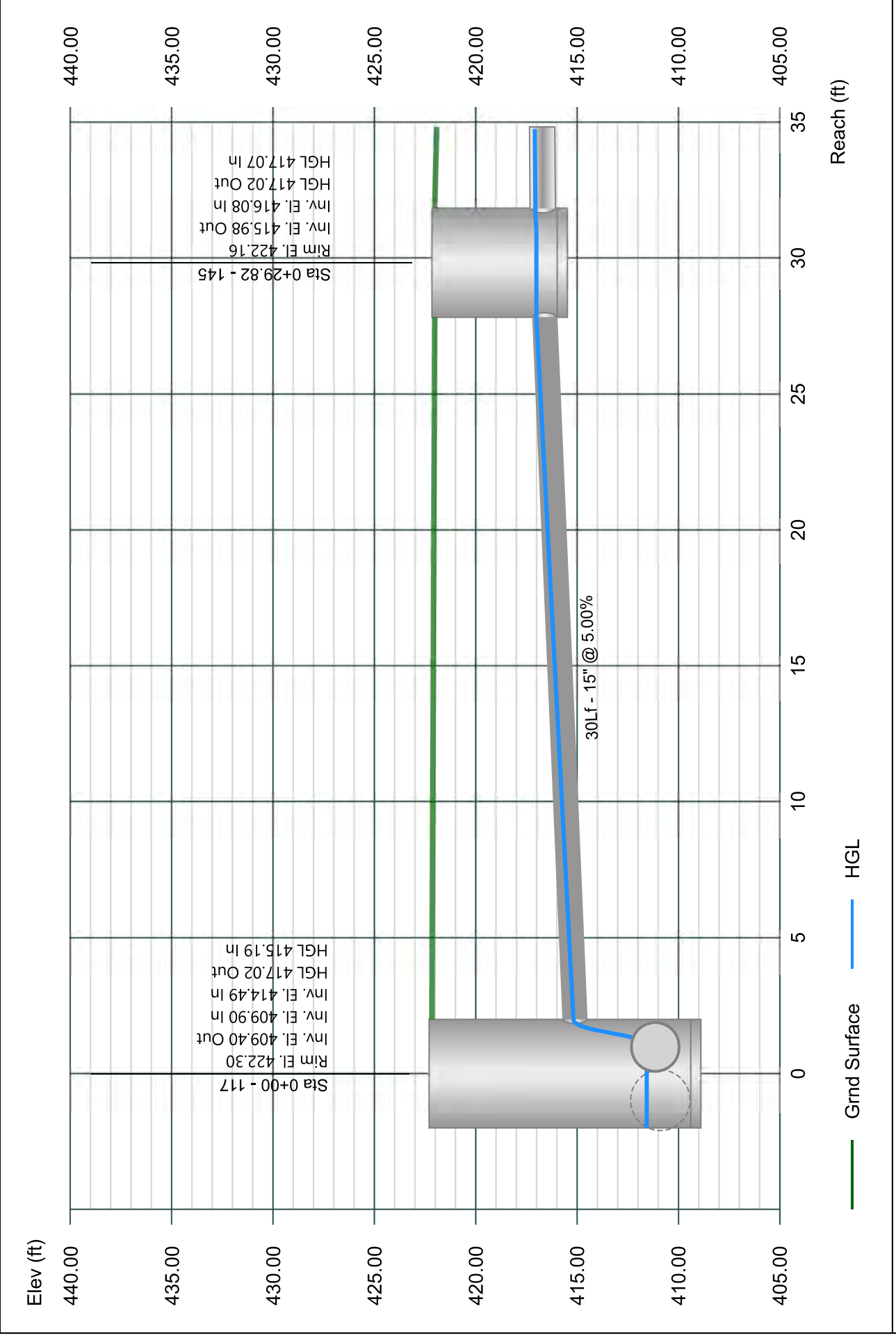

Line 46 - 146 to 145

Stormwater Studio 2024 v 3.0.0.33

Project Name: Enter Project Name...

01-19-2024

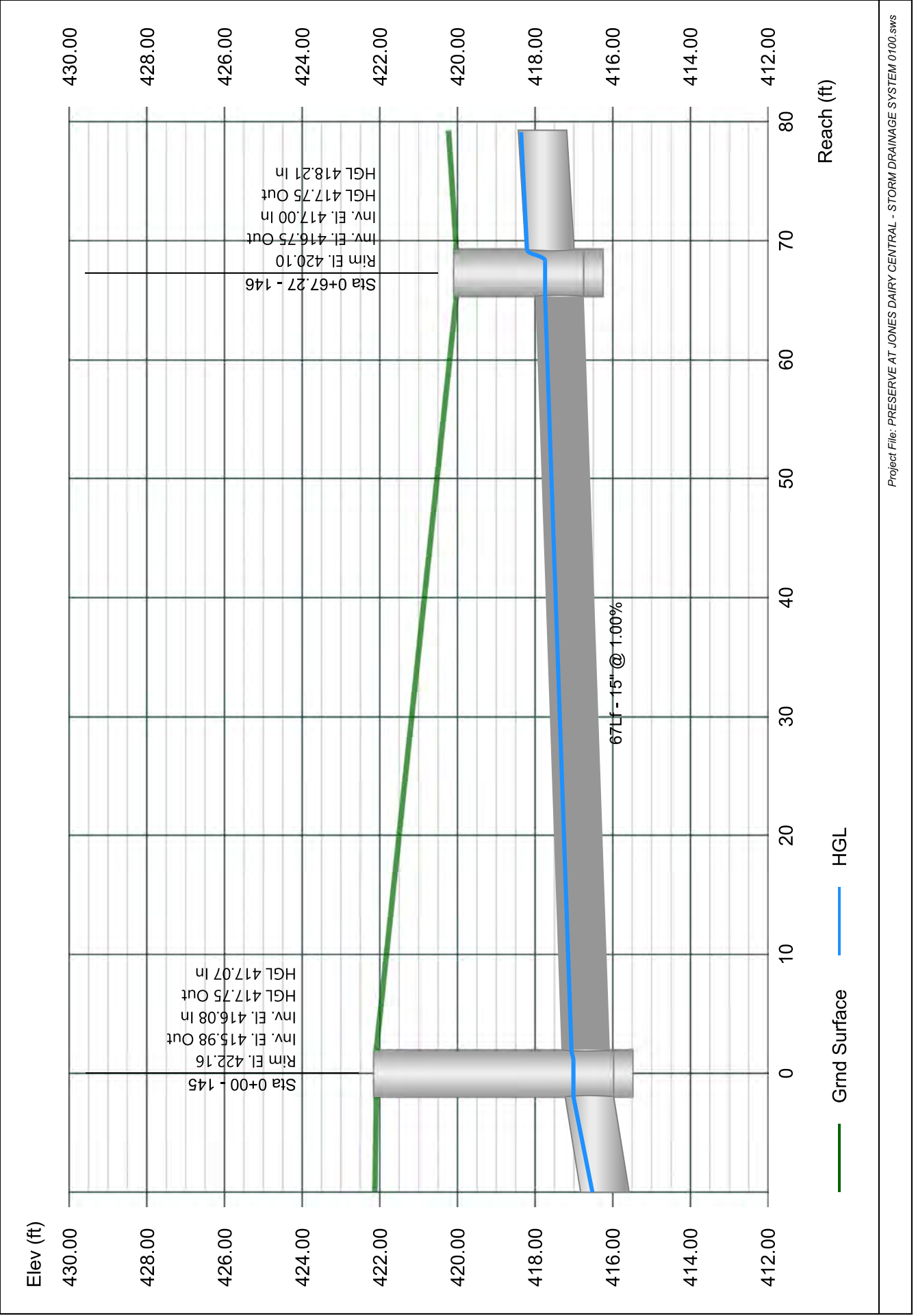

Line 47 - 147 to 146

Stormwater Studio 2024 v 3.0.0.33

Project Name: Enter Project Name...

01-19-2024

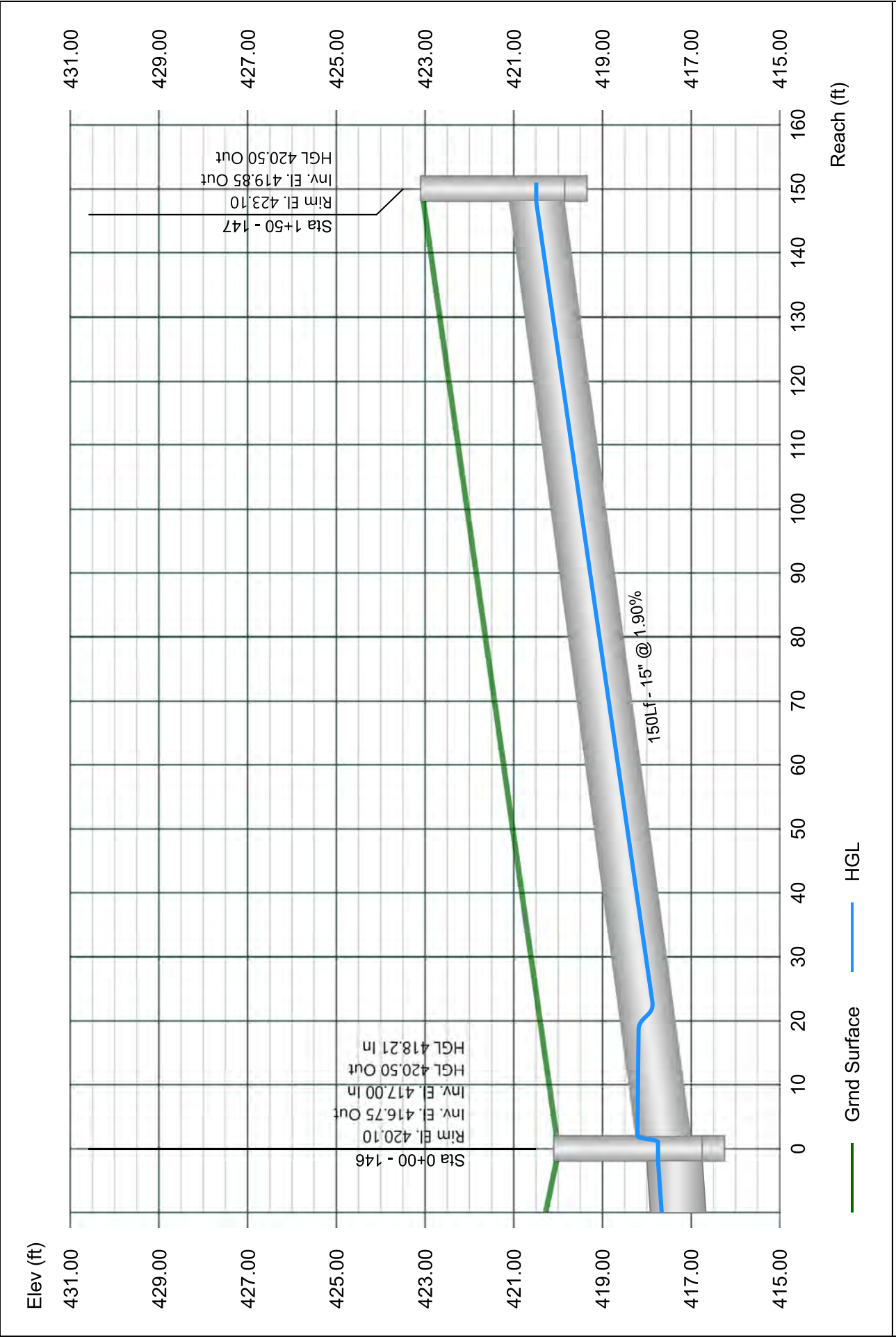

Line 48 - 148 TO 114

Stormwater Studio 2024 v 3.0.0.33

Project Name: Enter Project Name...

01-19-2024

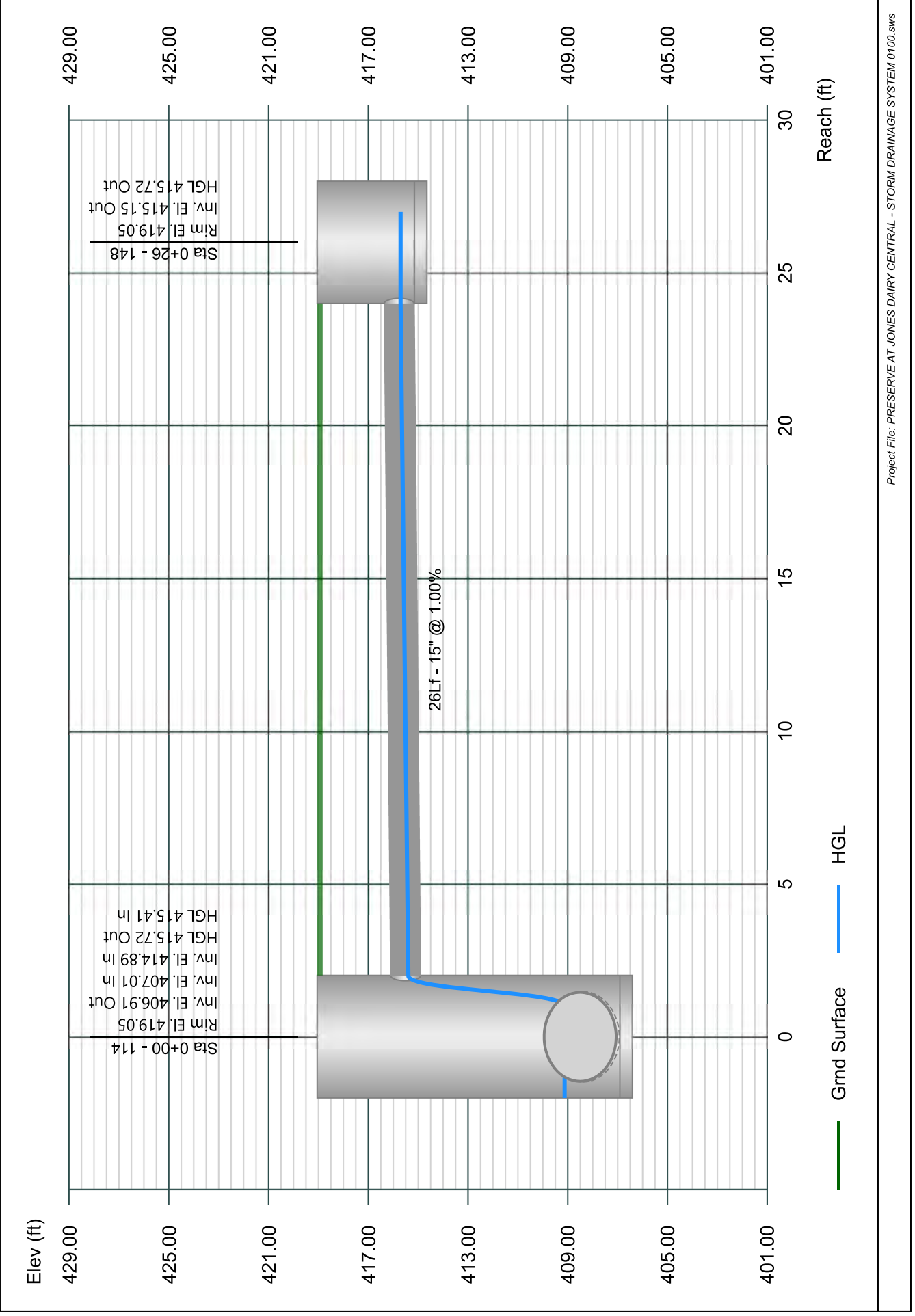

Line 49 - 149 TO 107

Stormwater Studio 2024 v 3.0.0.33

Project Name: Enter Project Name...

01-19-2024

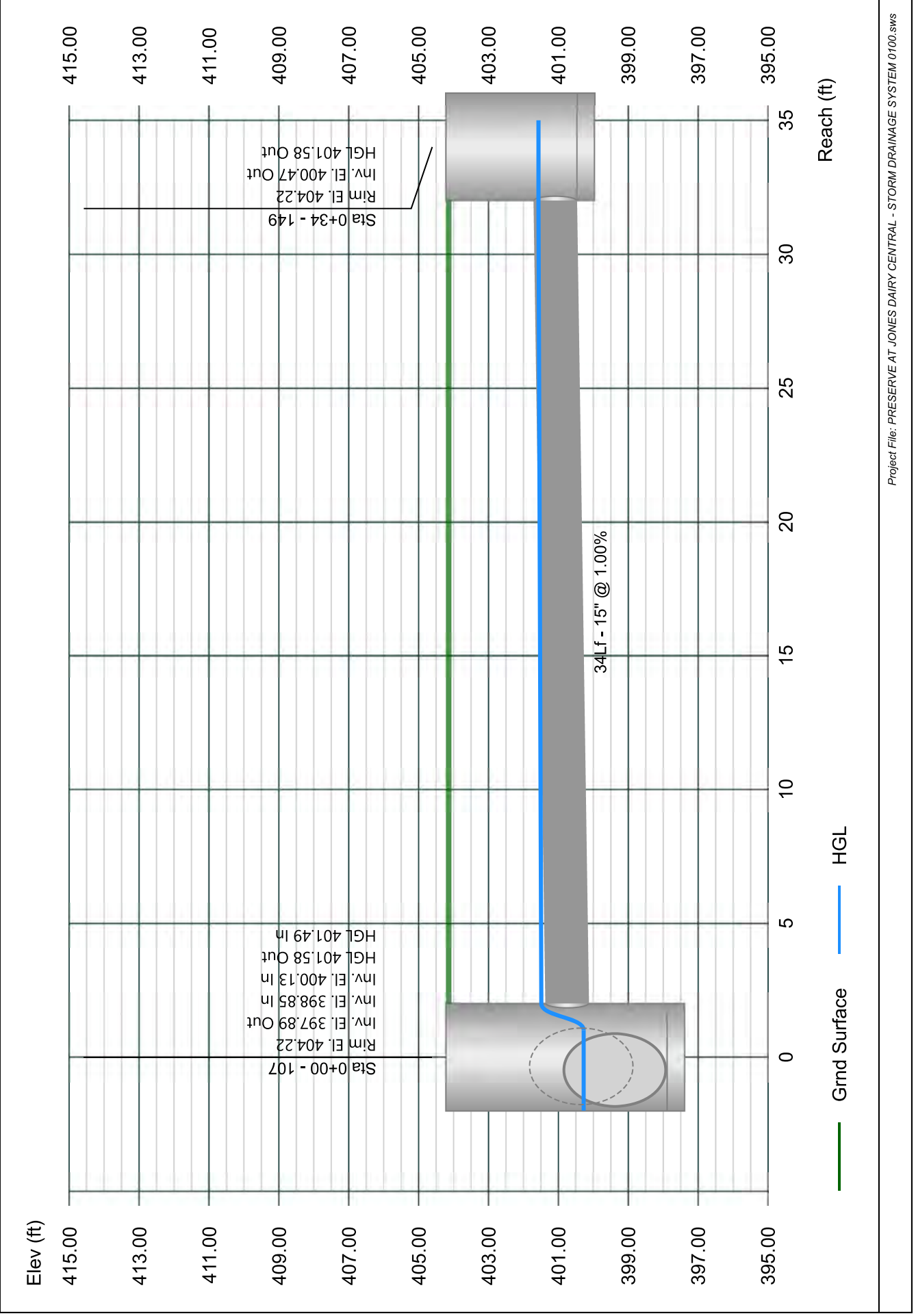

Line 50 - 150 TO 103

Stormwater Studio 2024 v 3.0.0.33

Project Name: Enter Project Name...

01-19-2024

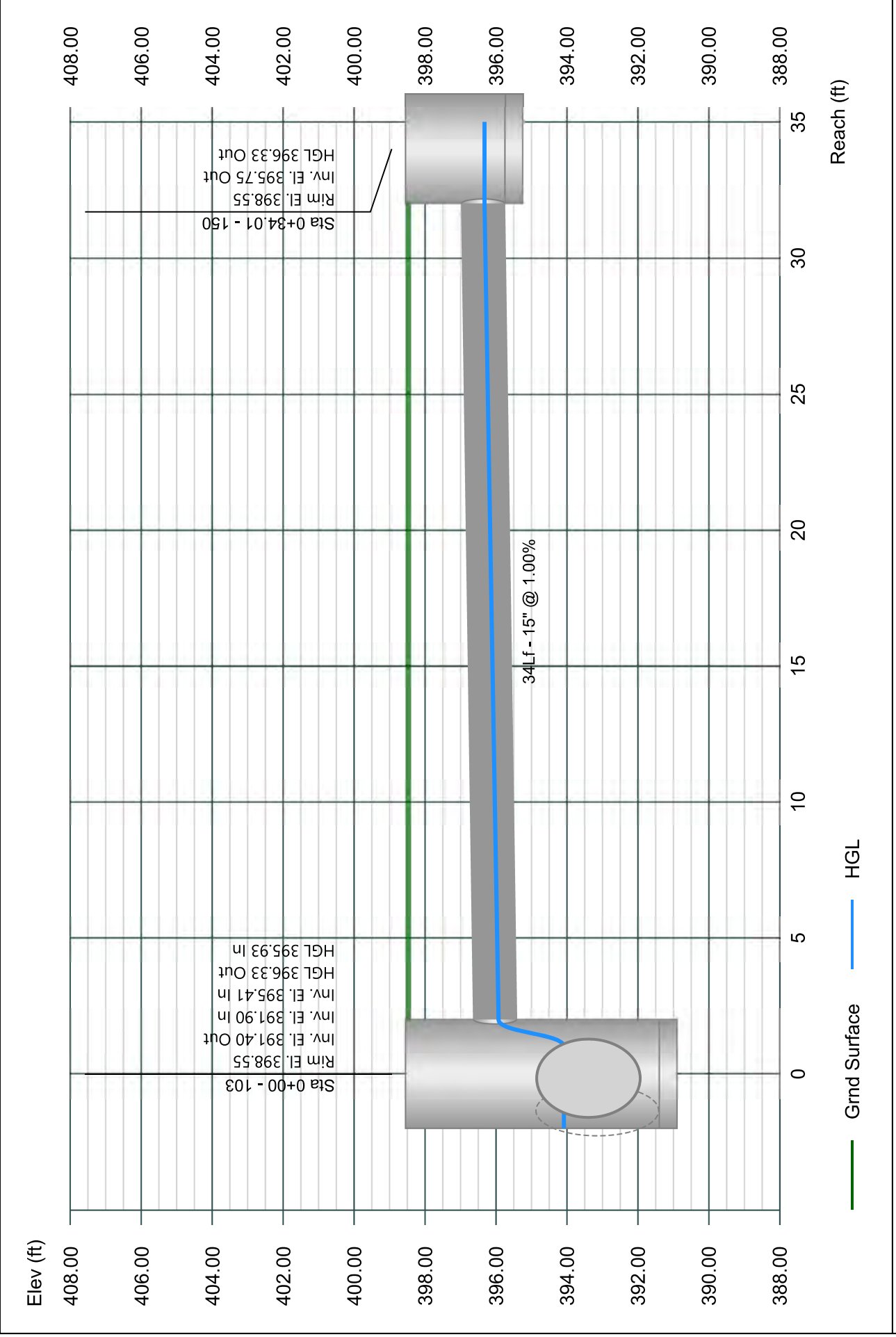

Line 51 - 151 TO 102

Stormwater Studio 2024 v 3.0.0.33

Project Name: Enter Project Name...

01-19-2024

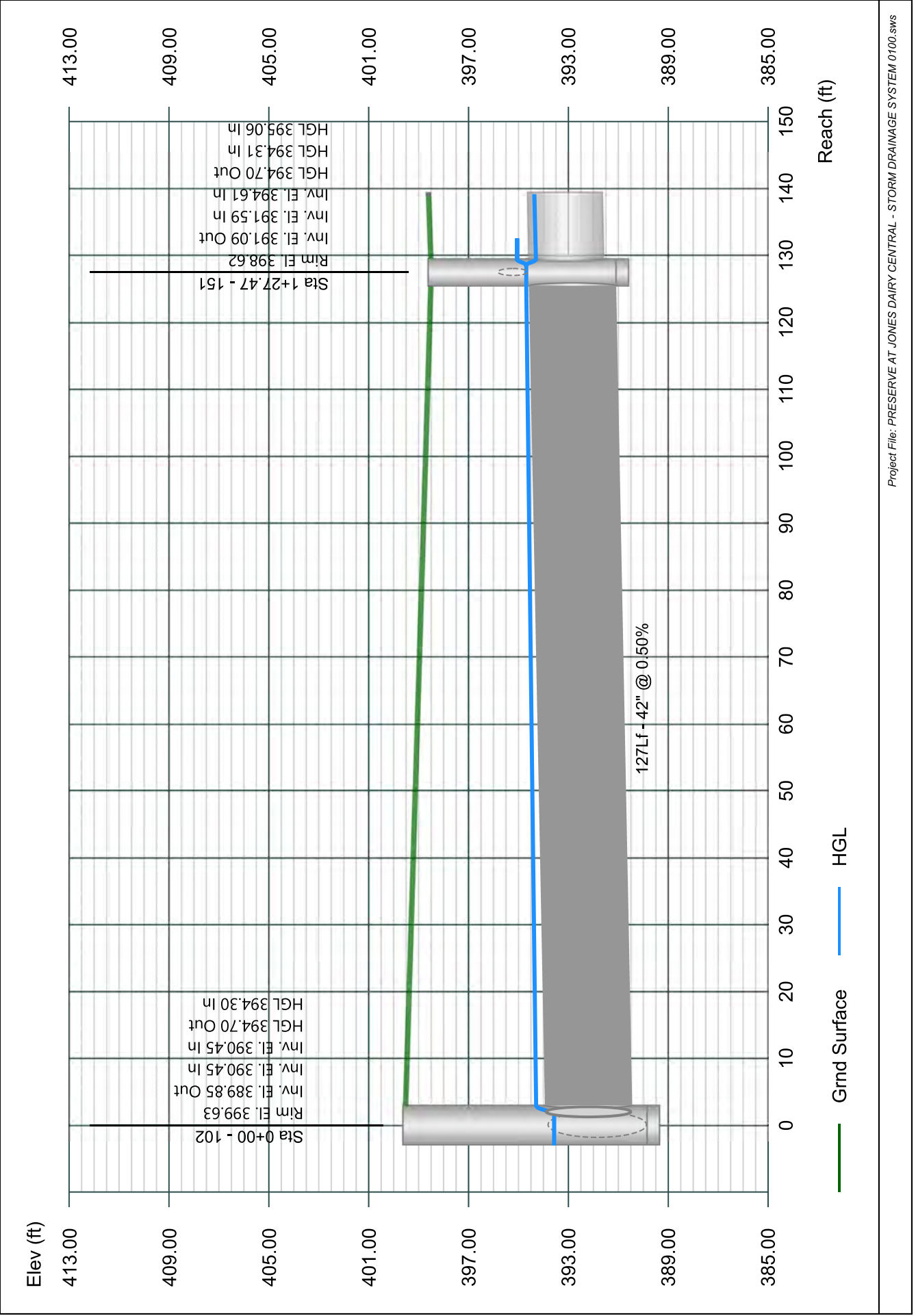

Line 52 - 152 TO 151

Stormwater Studio 2024 v 3.0.0.33

Project Name: Enter Project Name...

01-19-2024

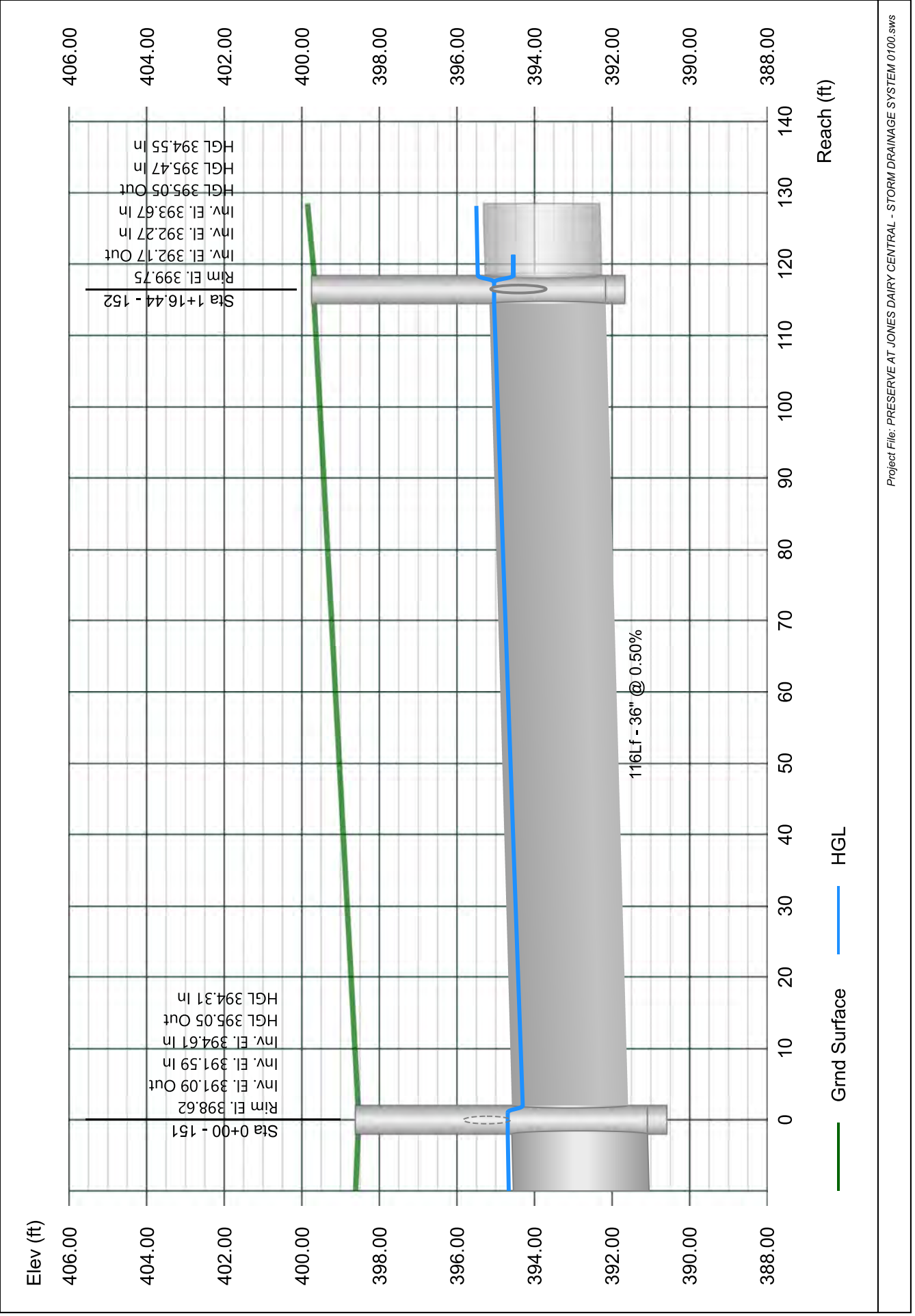

Line 53 - 153 TO 152

Stormwater Studio 2024 v 3.0.0.33

Project Name: Enter Project Name...

01-19-2024

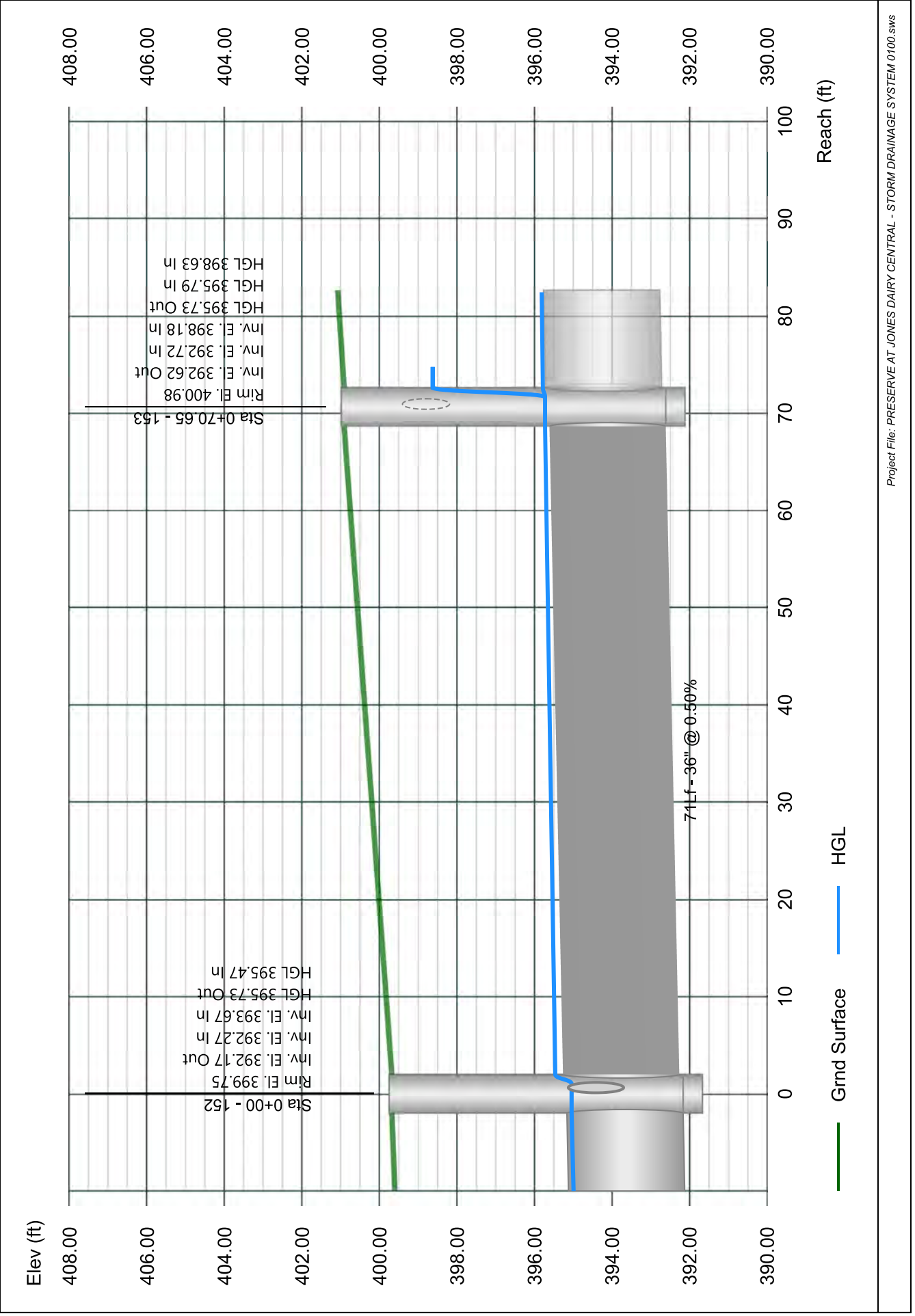

Line 54 - 154 TO 153

Stormwater Studio 2024 v 3.0.0.33

Project Name: Enter Project Name...

01-19-2024

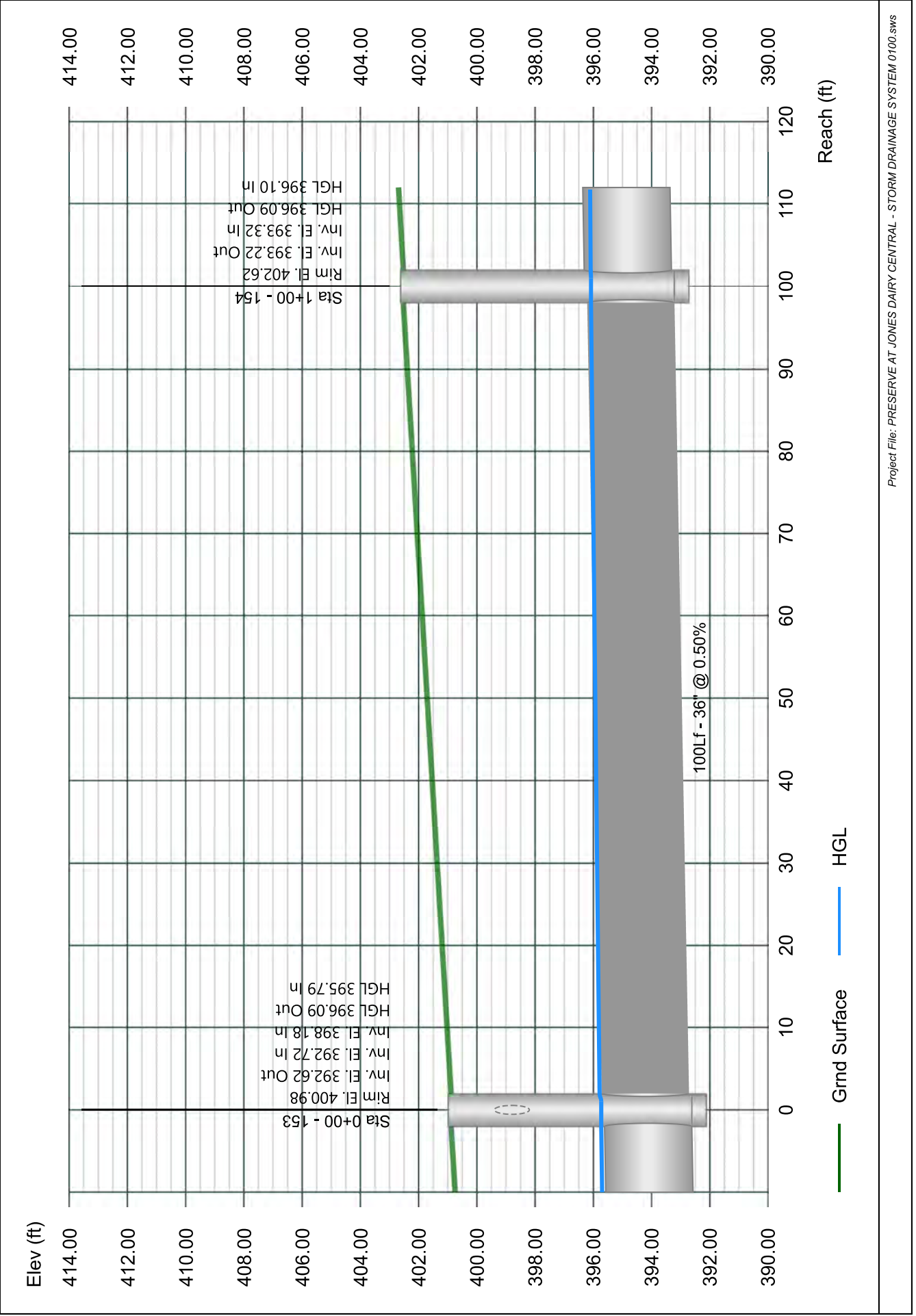

Line 55 - 155 TO 154

Stormwater Studio 2024 v 3.0.0.33

Project Name: Enter Project Name...

01-19-2024

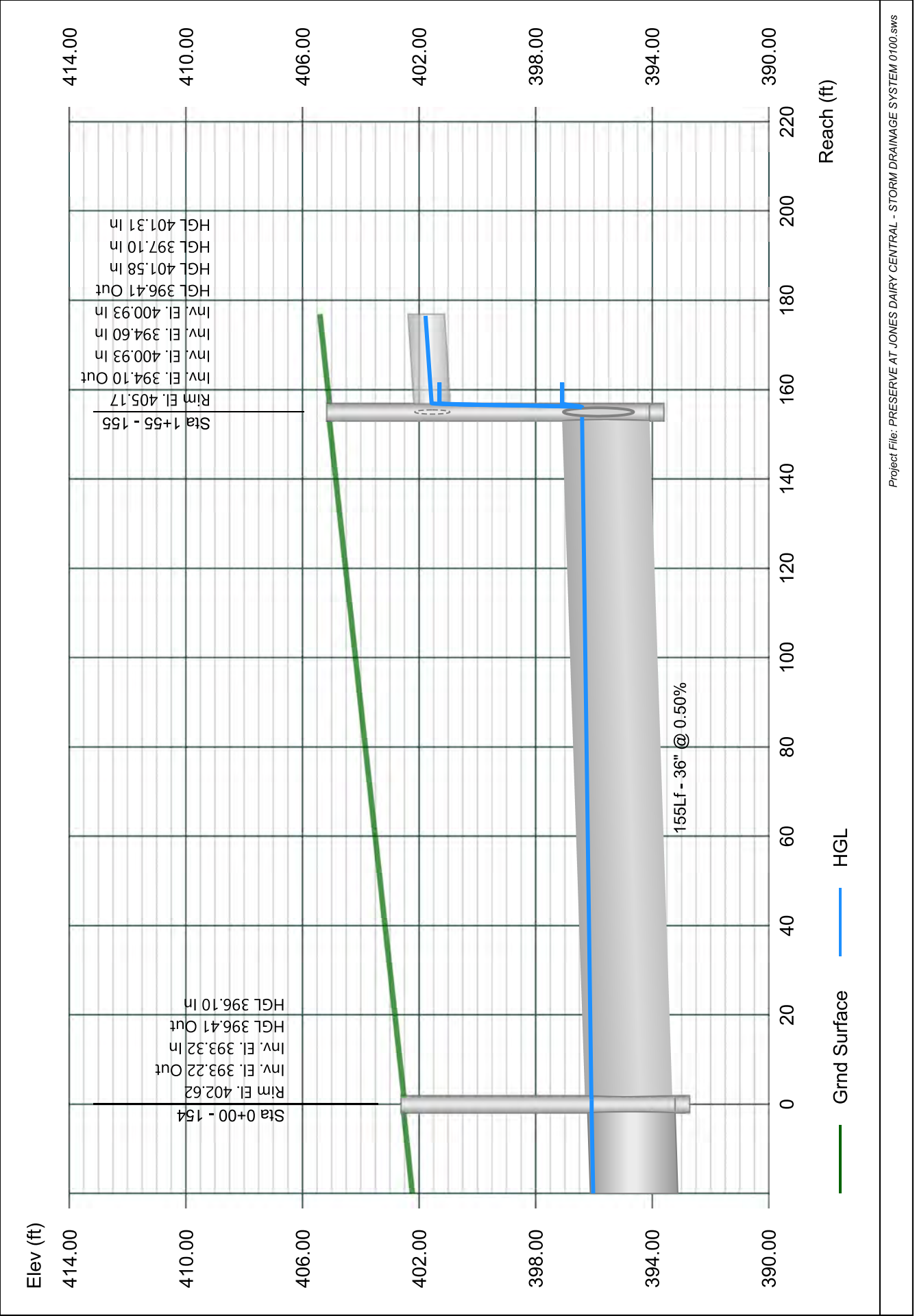

Line 56 - 156 TO 155

Stormwater Studio 2024 v 3.0.0.33

Project Name: Enter Project Name...

01-19-2024

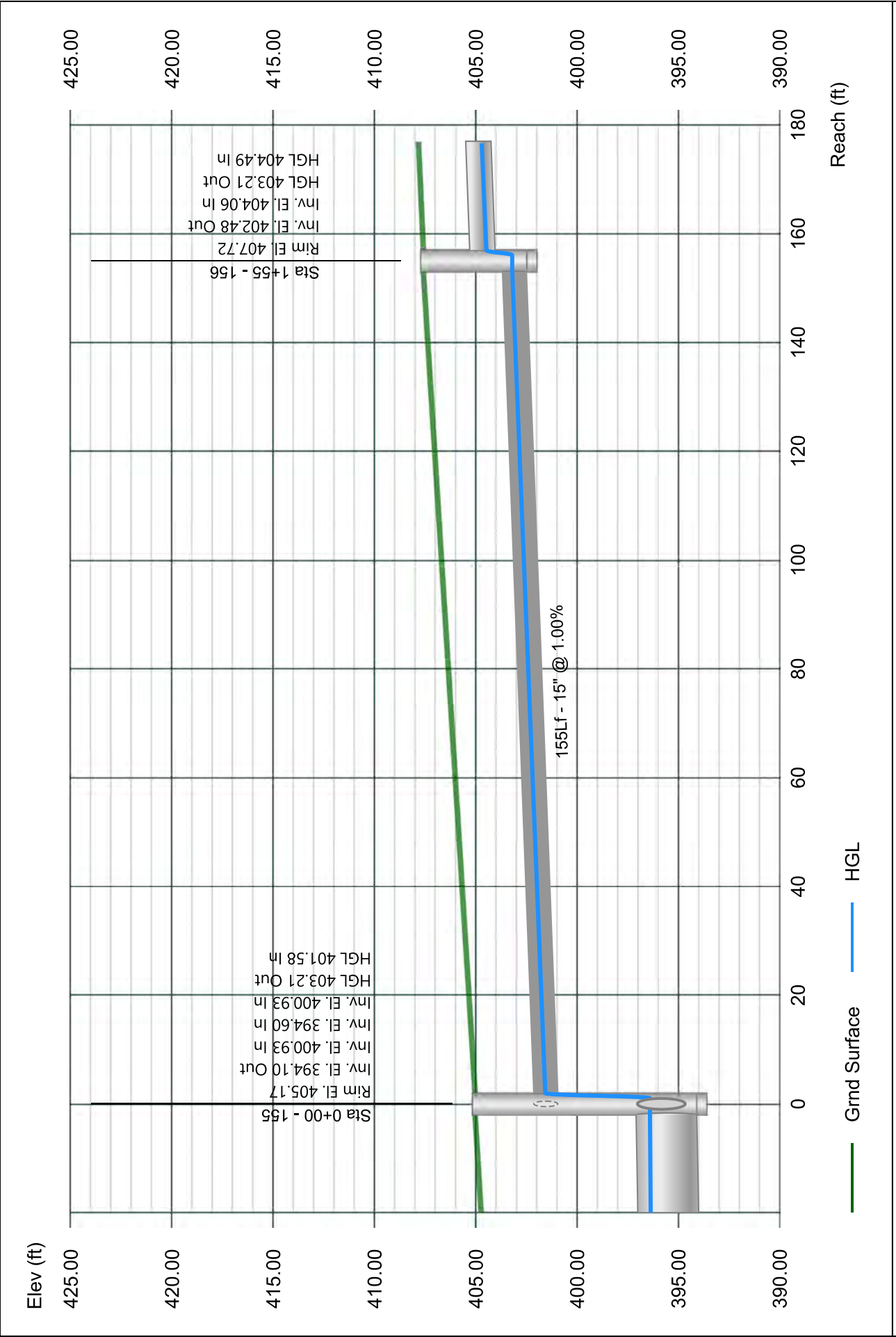

Line 57 - 157 TO 156

Stormwater Studio 2024 v 3.0.0.33

Project Name: Enter Project Name...

01-19-2024

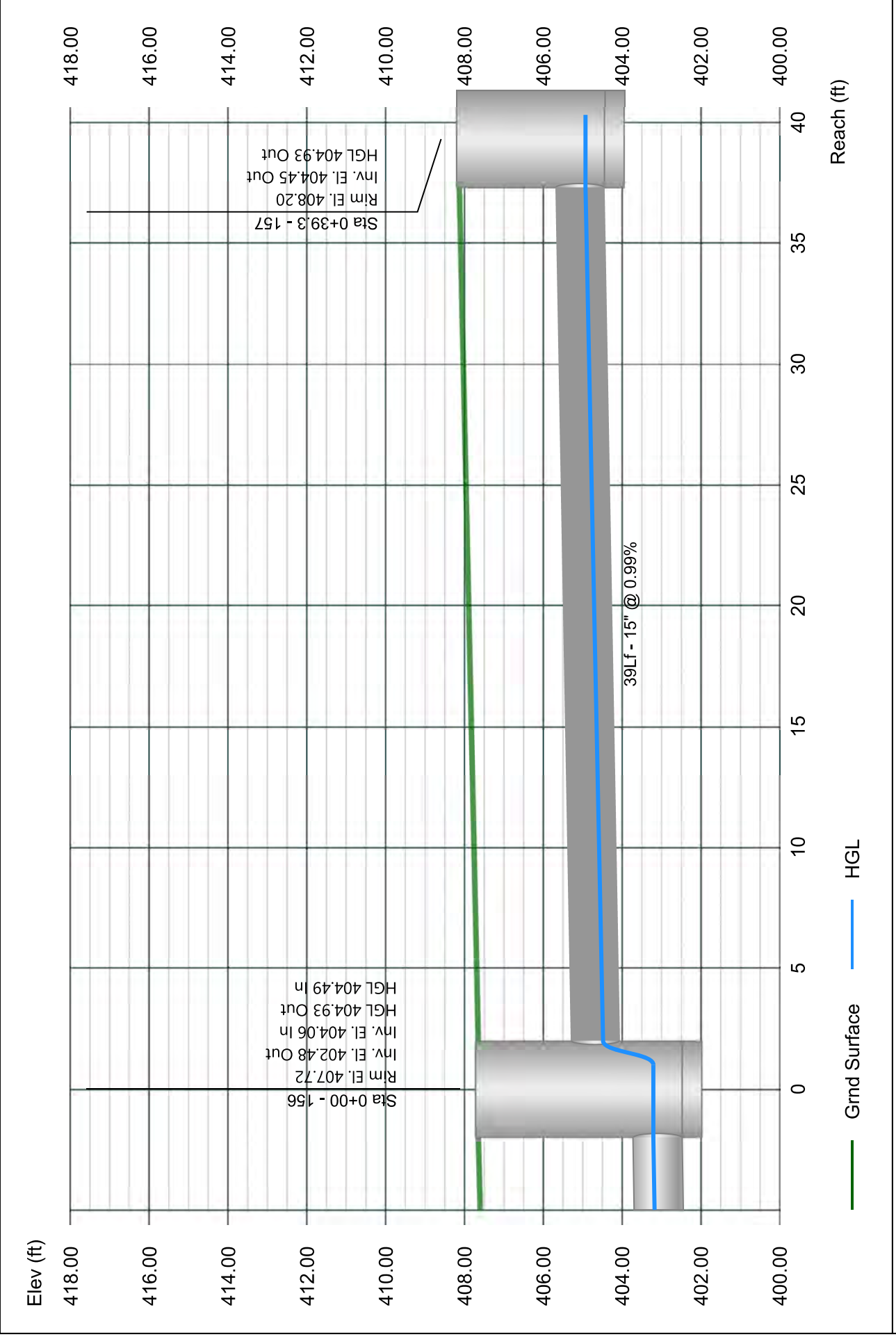

Line 58 - 158 TO 155

Stormwater Studio 2024 v 3.0.0.33

Project Name: Enter Project Name...

01-19-2024

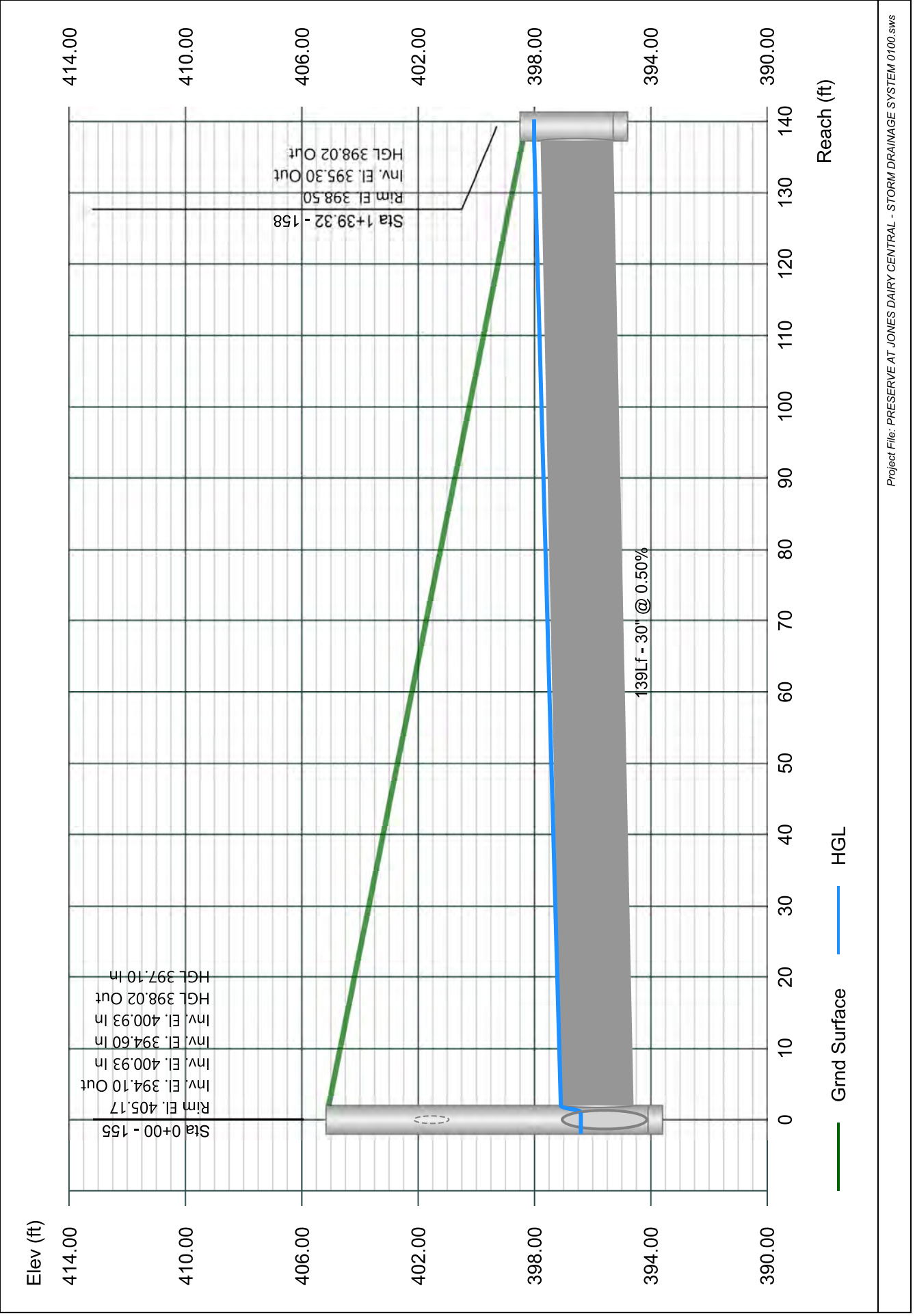

Line 59 - 159 TO 155

Stormwater Studio 2024 v 3.0.0.33

Project Name: Enter Project Name...

01-19-2024

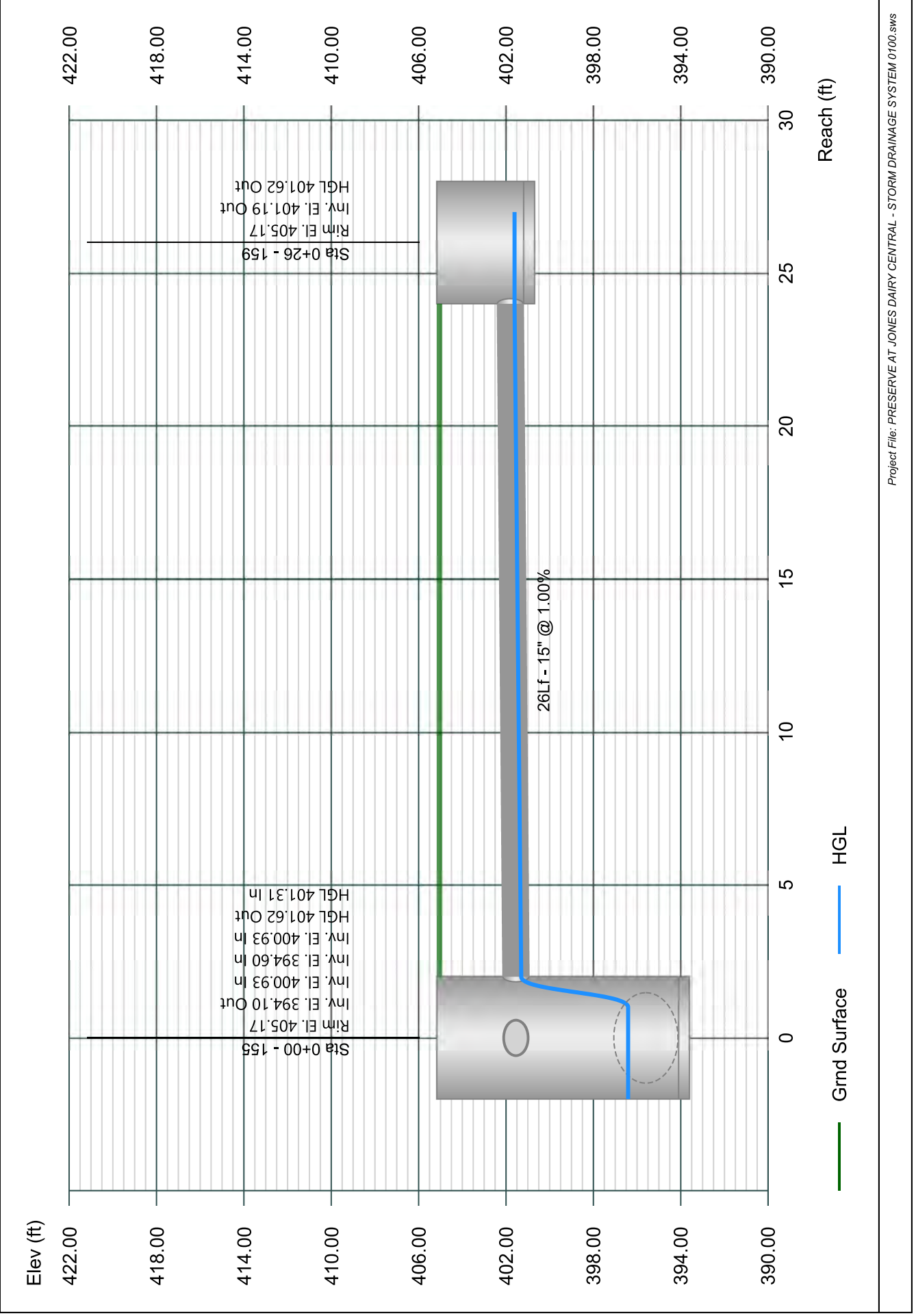

Line 60 - 160 TO 153

Stormwater Studio 2024 v 3.0.0.33

Project Name: Enter Project Name...

01-19-2024

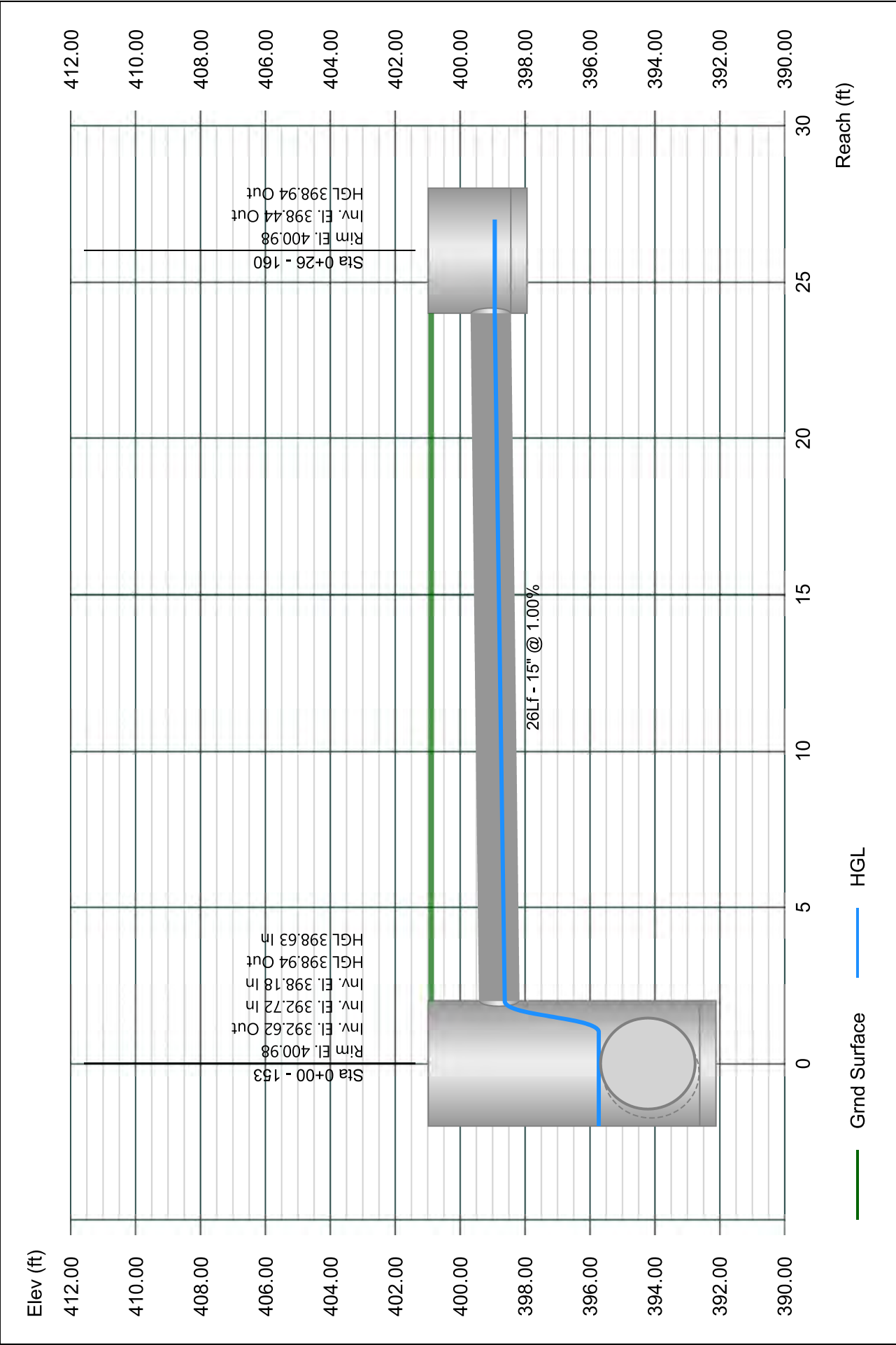

Line 61 - 161 TO 152

Stormwater Studio 2024 v 3.0.0.33

Project Name: Enter Project Name...

01-19-2024

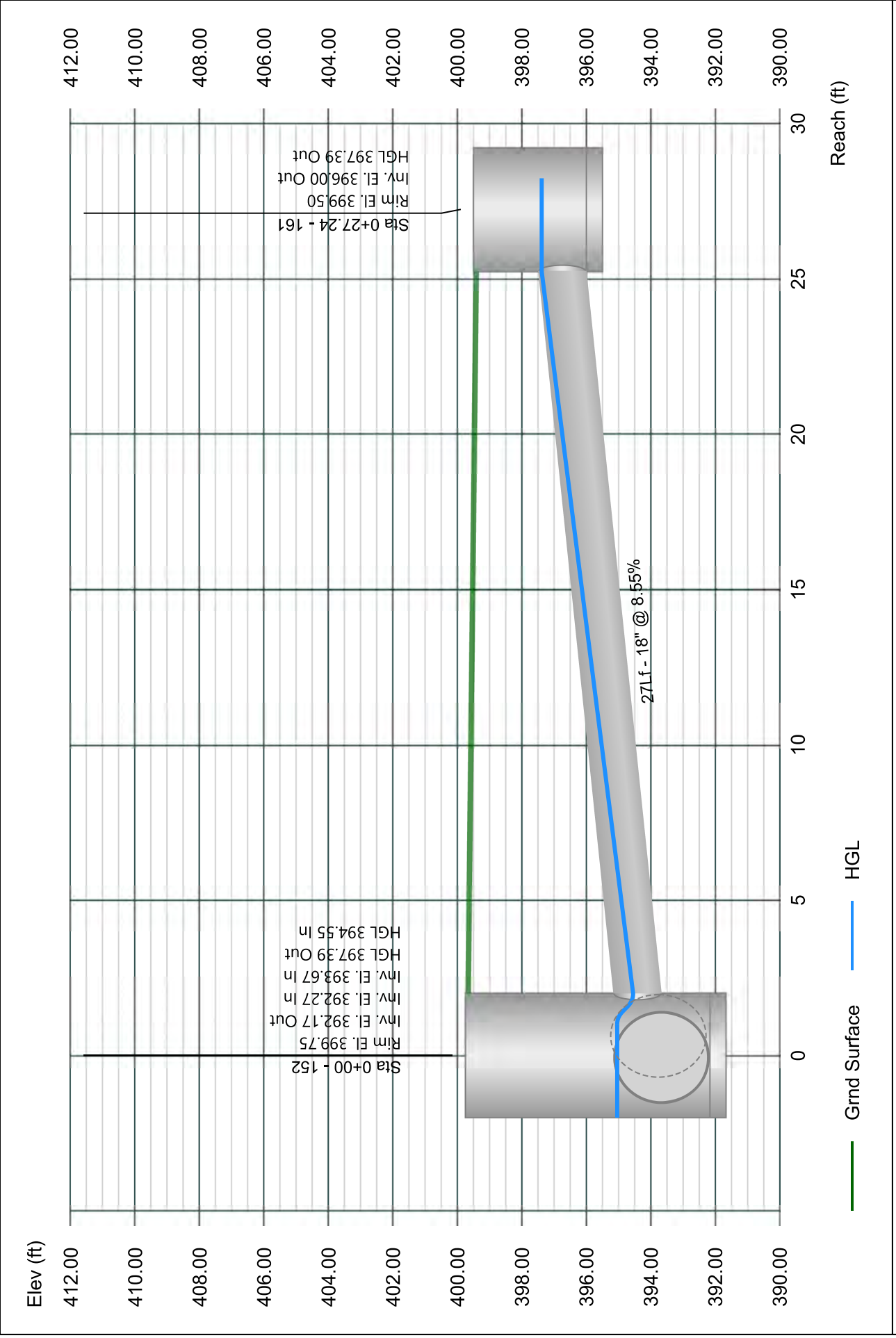

Line 62 - 163 TO 151

Stormwater Studio 2024 v 3.0.0.33

Project Name: Enter Project Name...

01-19-2024

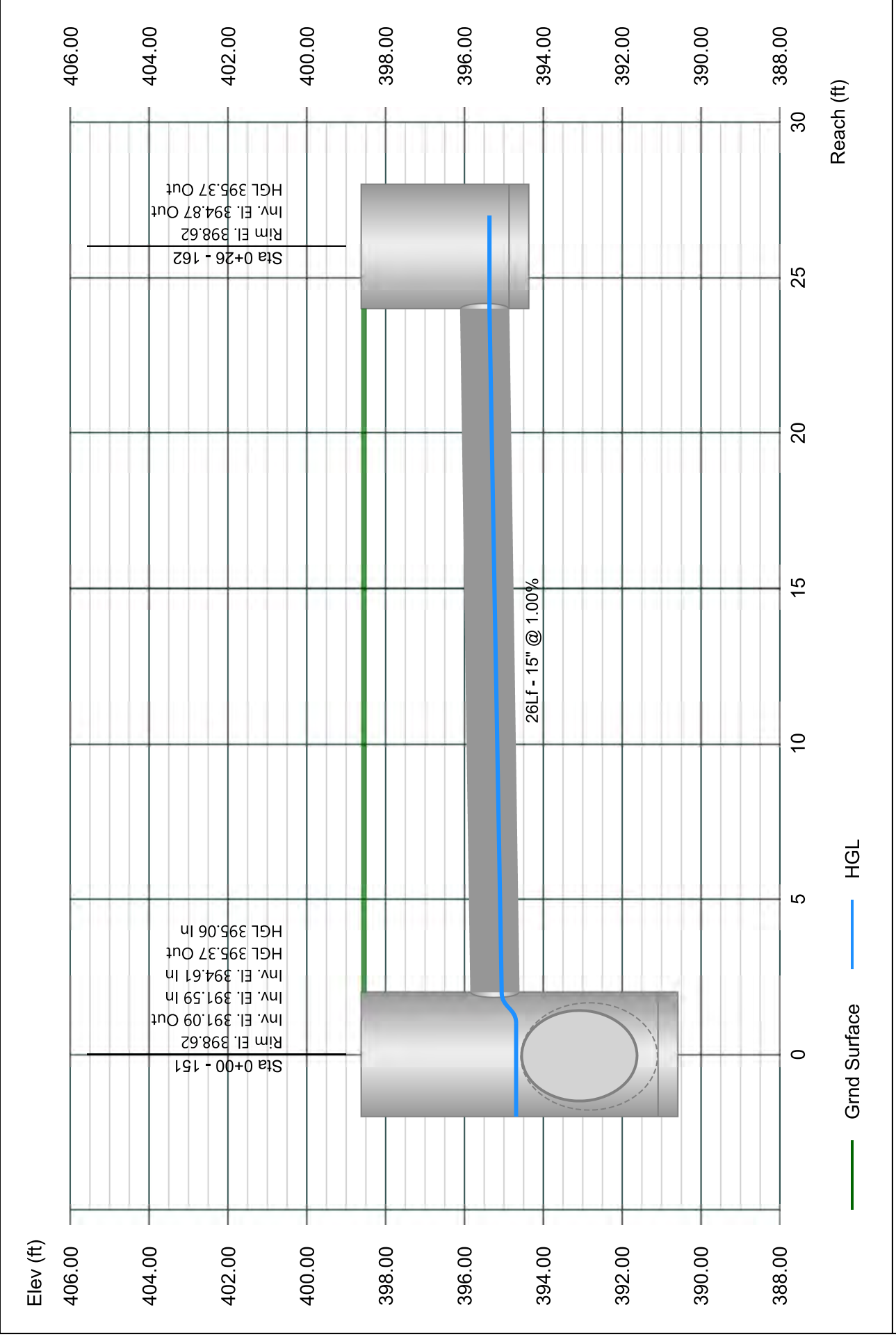

Line 63 - 163 TO 101

Stormwater Studio 2024 v 3.0.0.33

Project Name: Enter Project Name...

01-19-2024

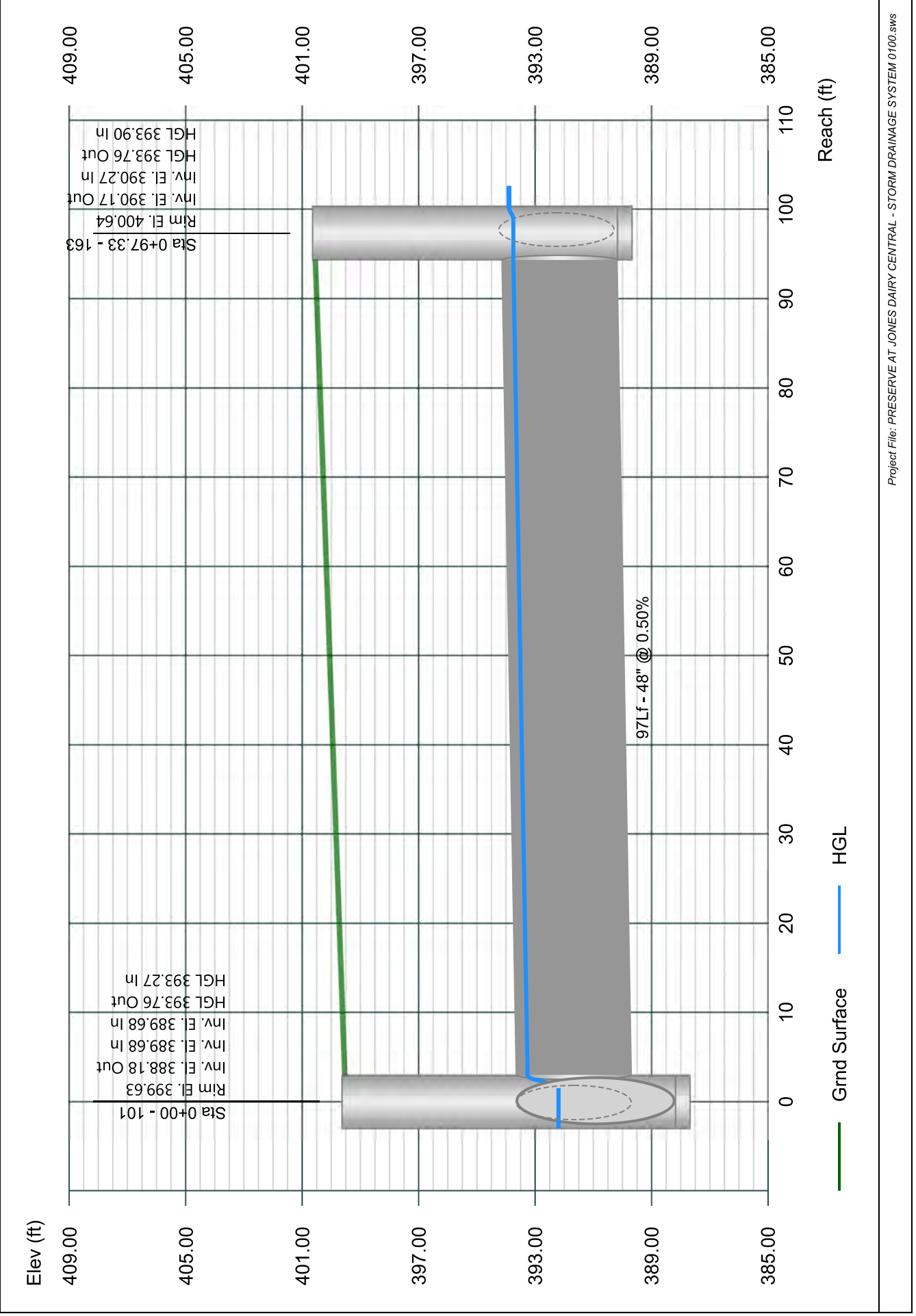

Line 64 - 164 TO 163

Stormwater Studio 2024 v 3.0.0.33

Project Name: Enter Project Name...

01-19-2024

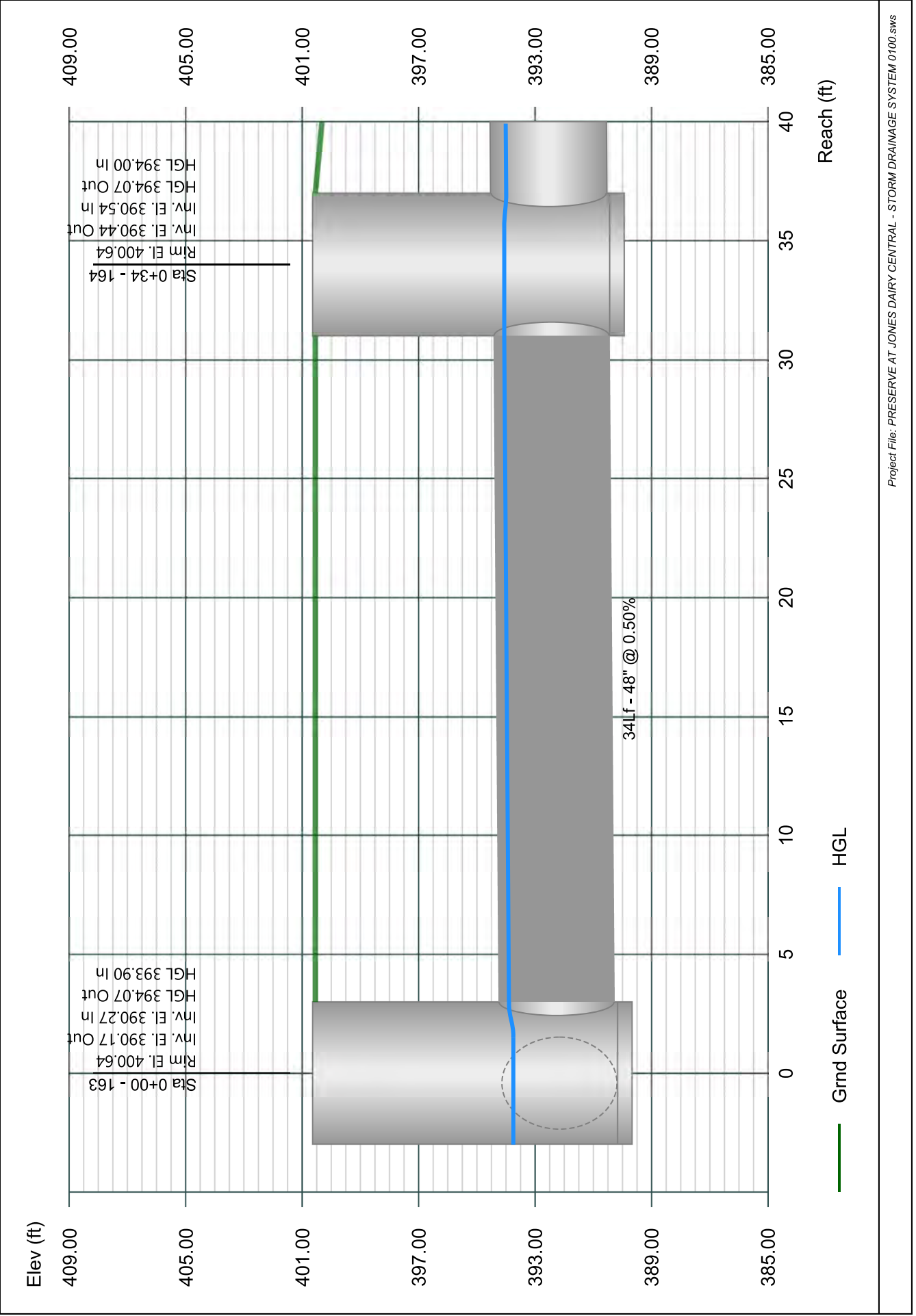

Line 65 - 165 TO 164

Stormwater Studio 2024 v 3.0.0.33

Project Name: Enter Project Name...

01-19-2024

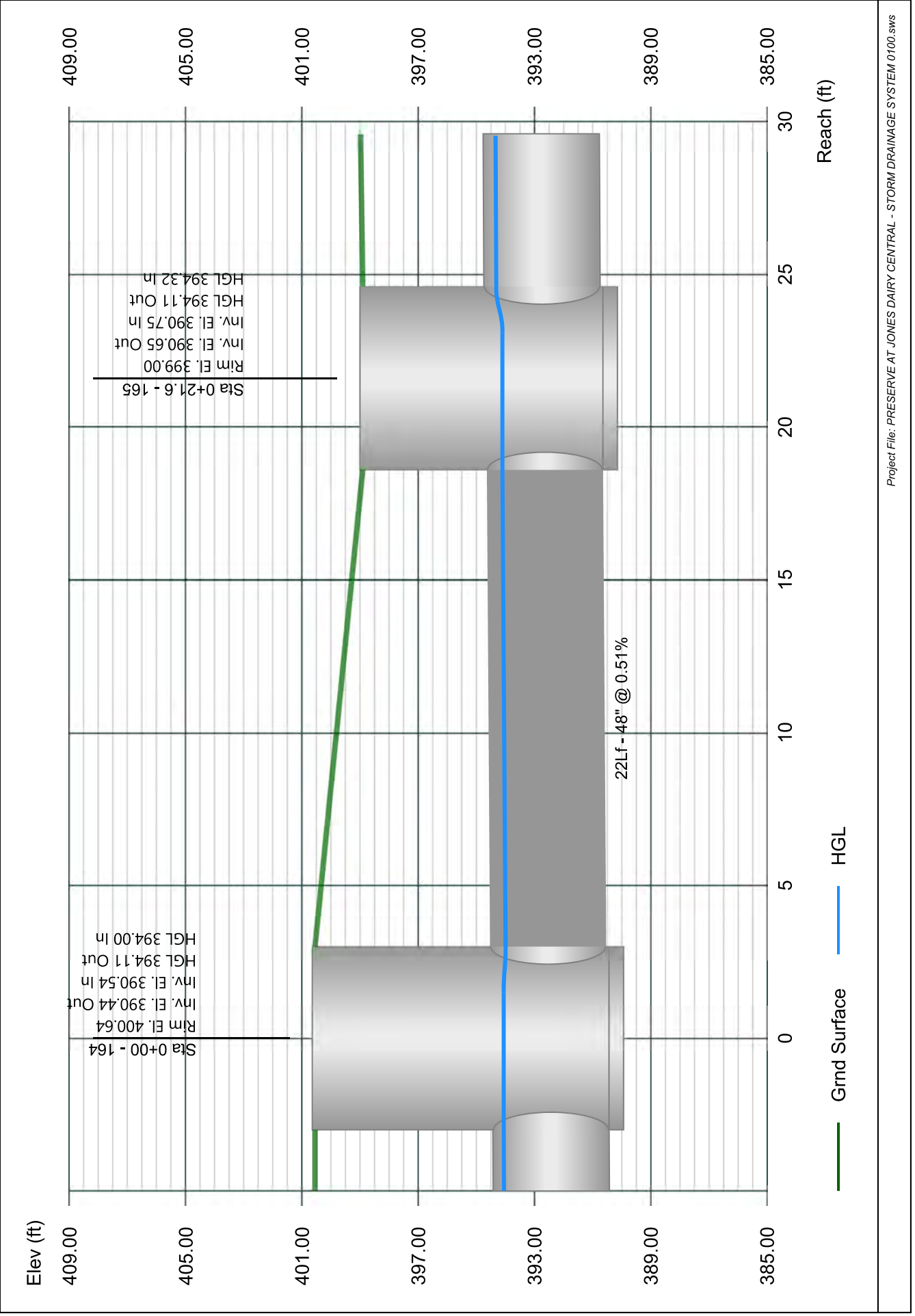

Line 66 - 166 TO 165

Stormwater Studio 2024 v 3.0.0.33

Project Name: Enter Project Name...

01-19-2024

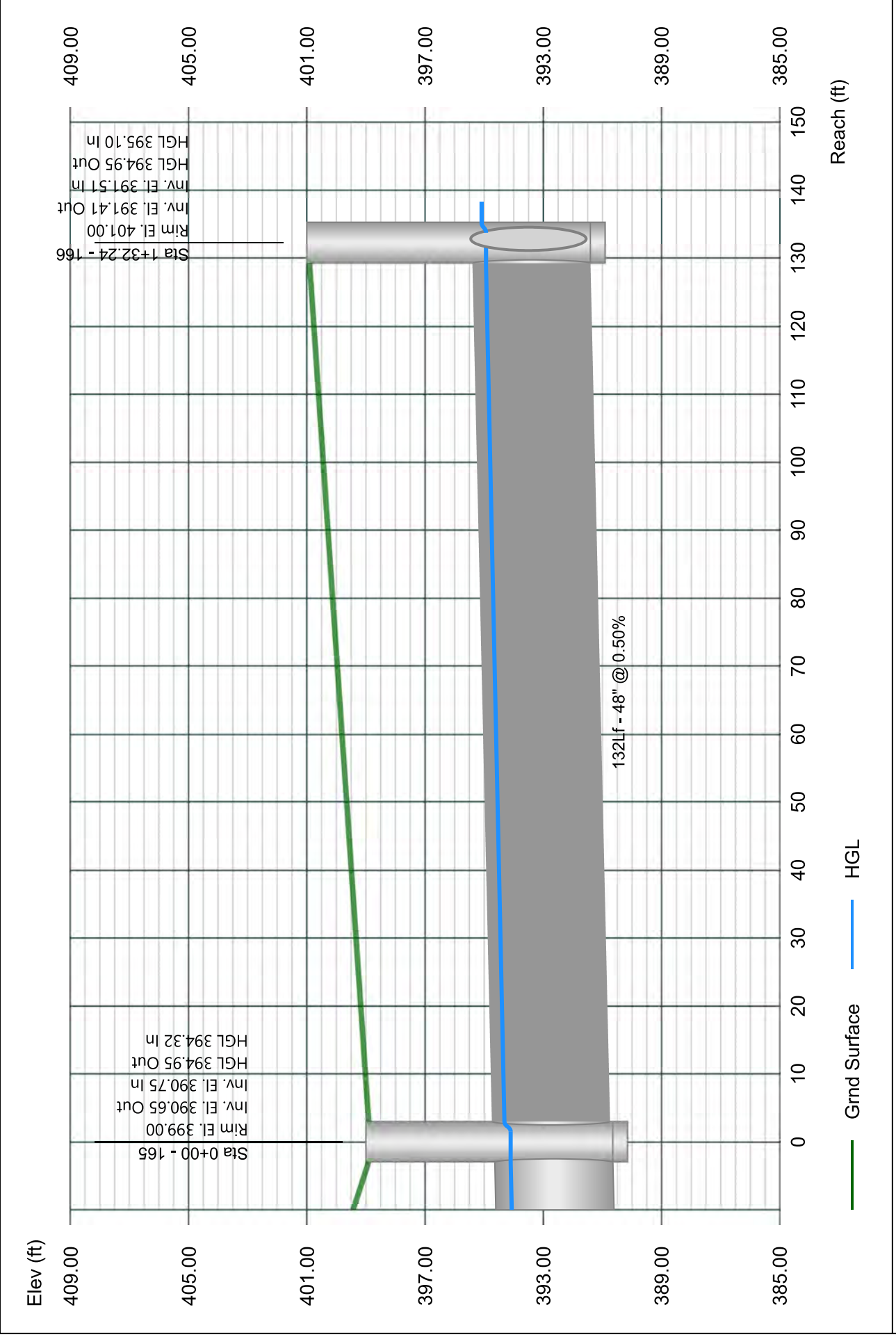

Line 67 - 167 TO 166

Stormwater Studio 2024 v 3.0.0.33

Project Name: Enter Project Name...

01-19-2024

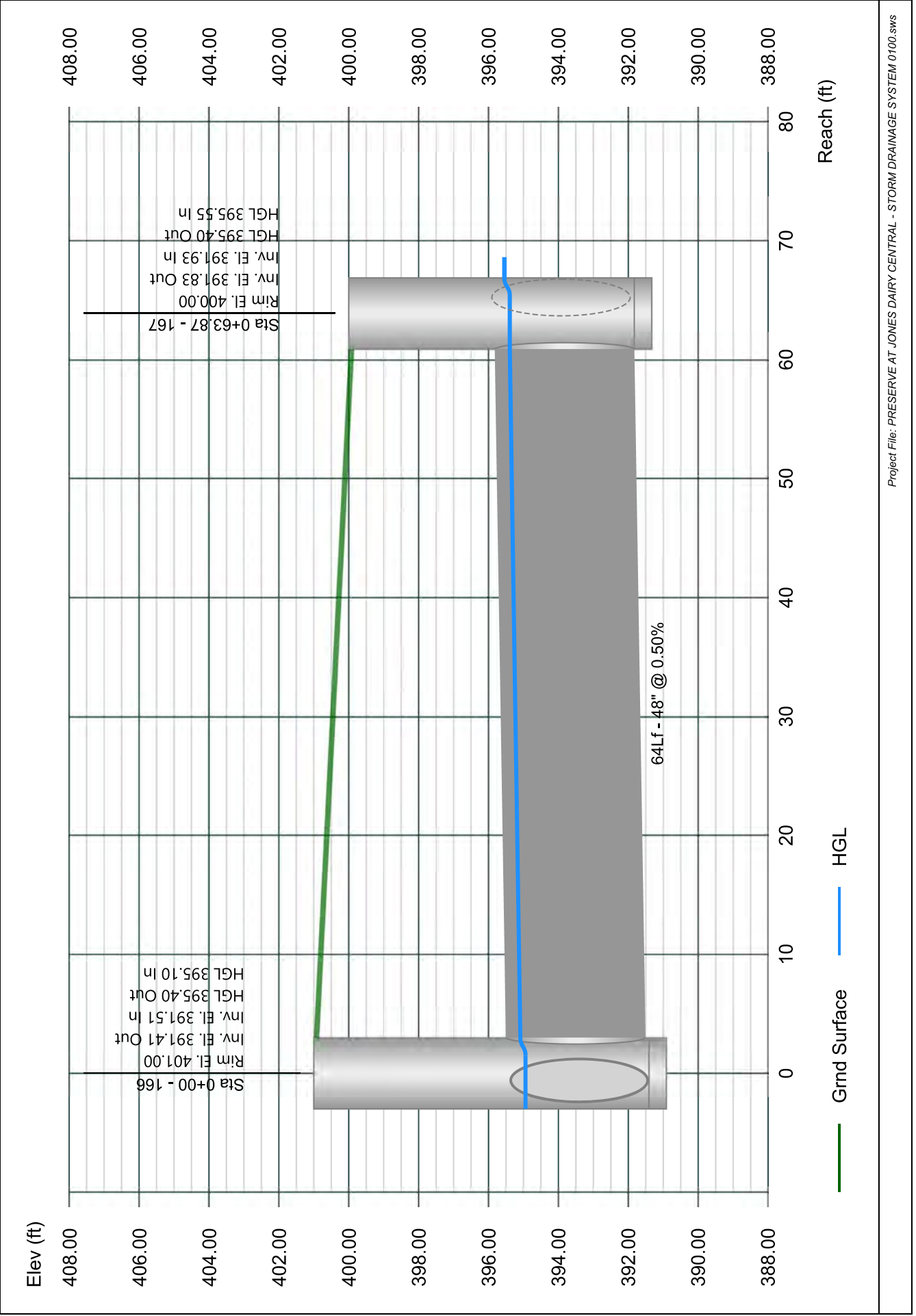

Line 68 - 168 TO 167

Stormwater Studio 2024 v 3.0.0.33

Project Name: Enter Project Name...

01-19-2024

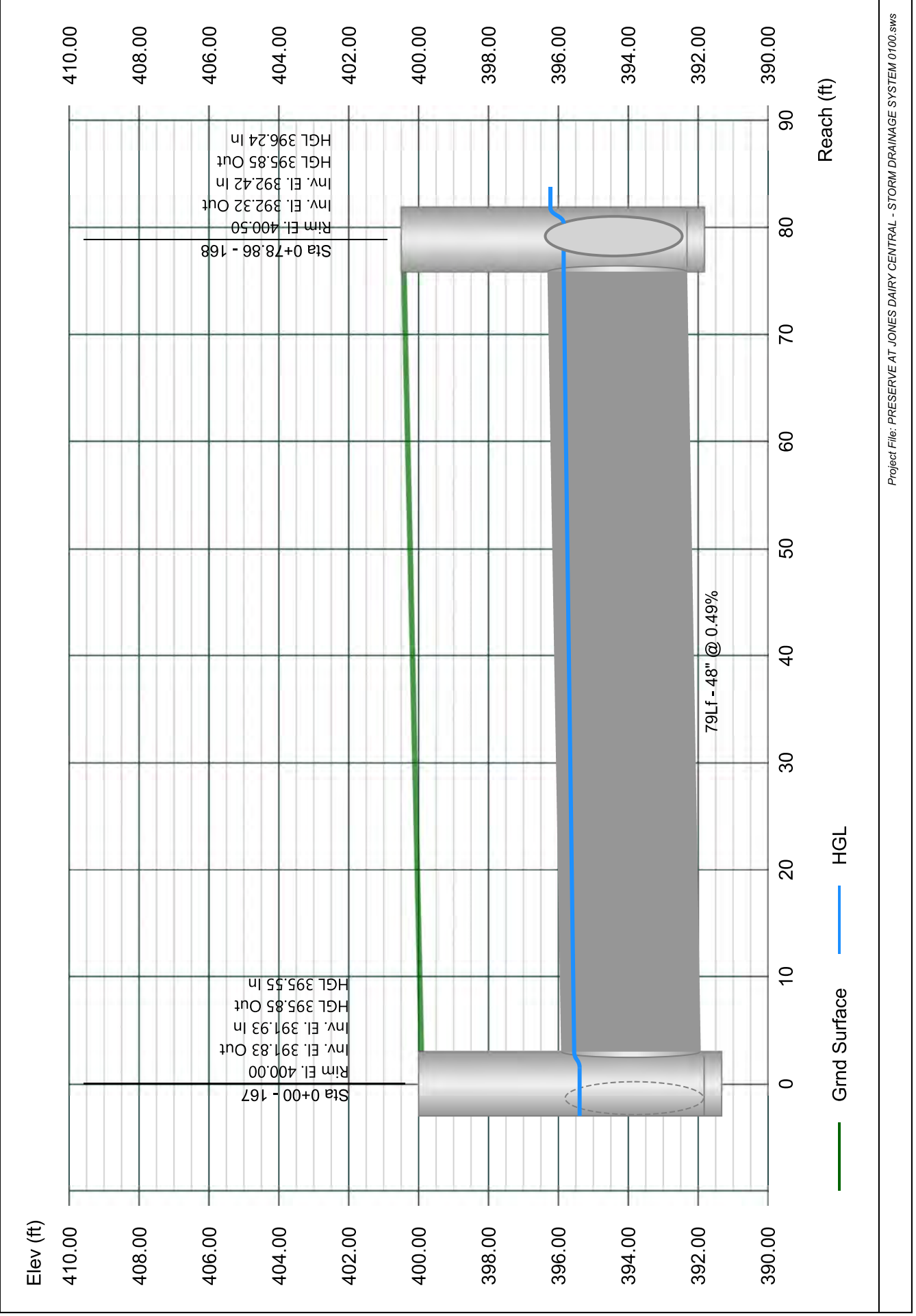

Line 69 - 169 TO 168

Stormwater Studio 2024 v 3.0.0.33

Project Name: Enter Project Name...

01-19-2024

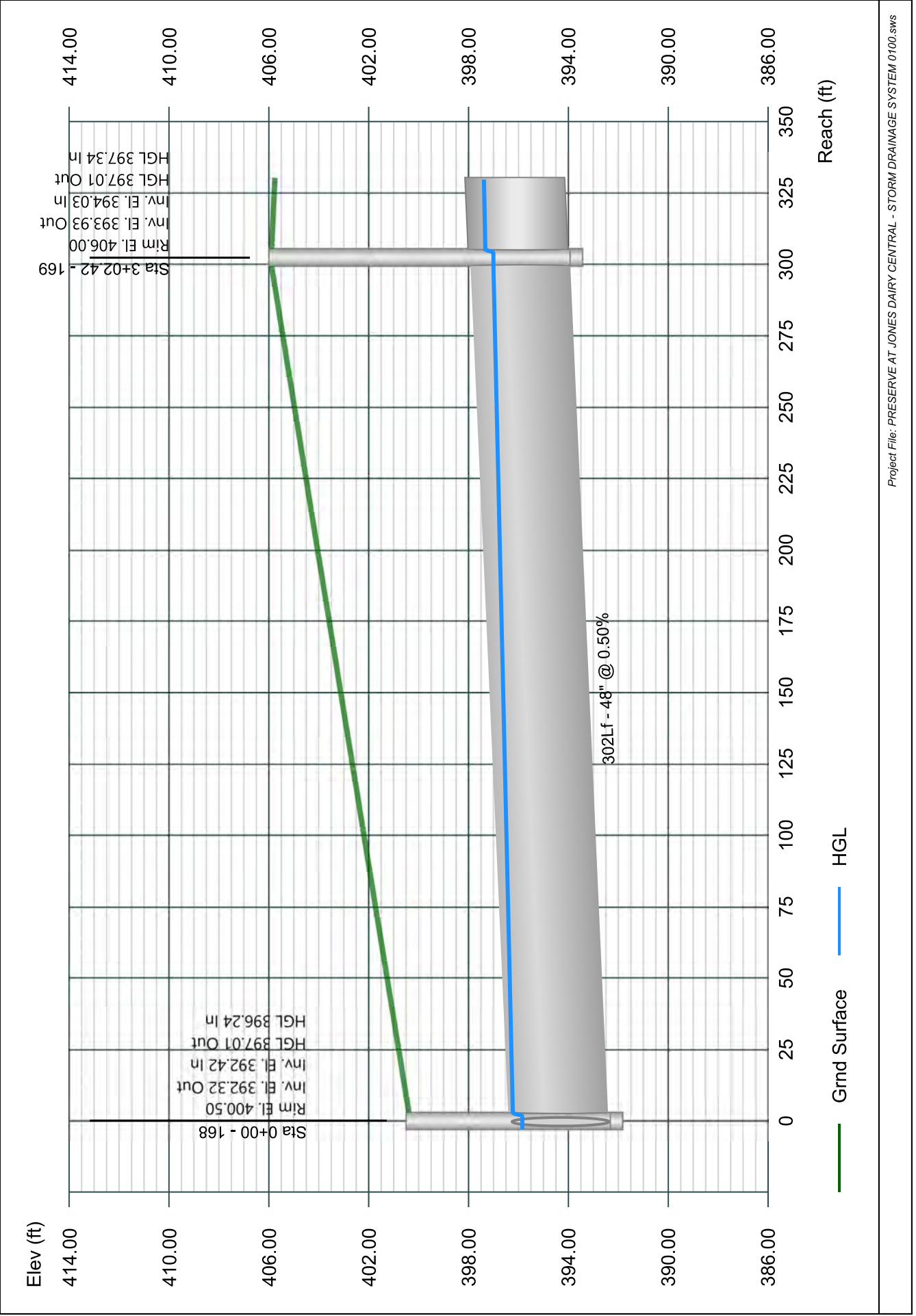

Line 70 - 170 TO 169

Stormwater Studio 2024 v 3.0.0.33

Project Name: Enter Project Name...

01-19-2024

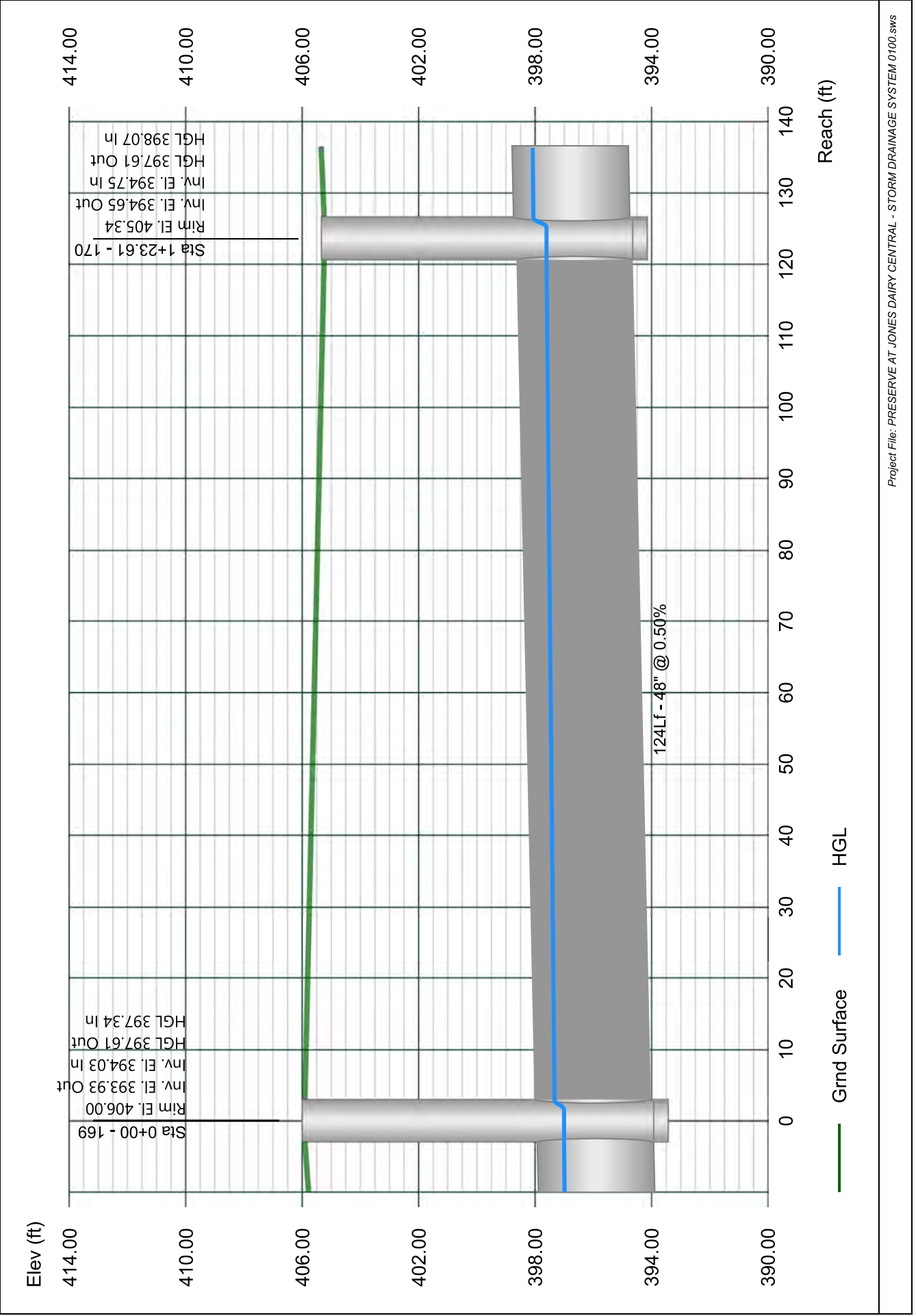

Line 71 - 171 TO 170

Stormwater Studio 2024 v 3.0.0.33

Project Name: Enter Project Name...

01-19-2024

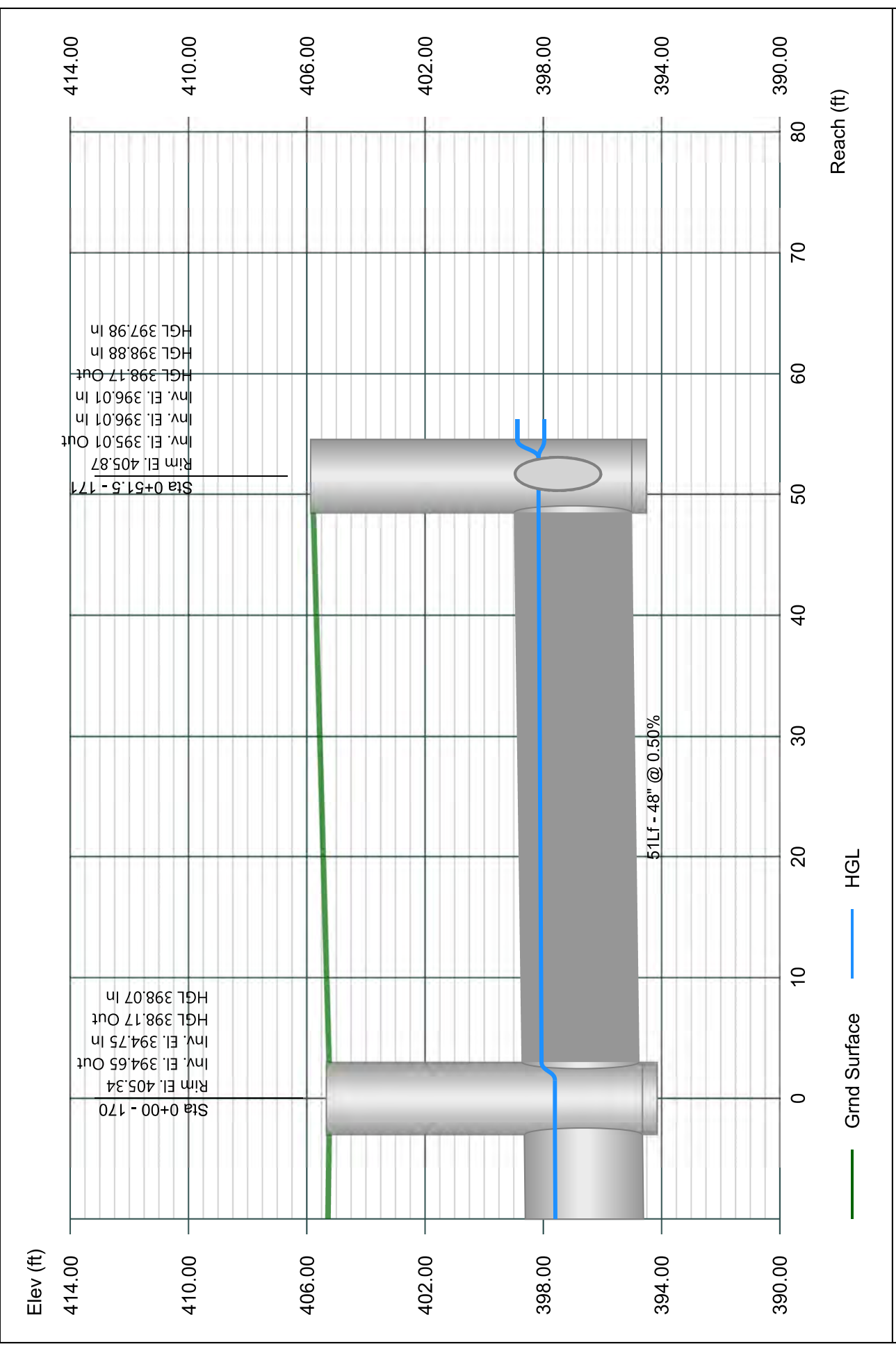

Line 72 - 172 TO 171

Stormwater Studio 2024 v 3.0.0.33

Project Name: Enter Project Name...

01-19-2024

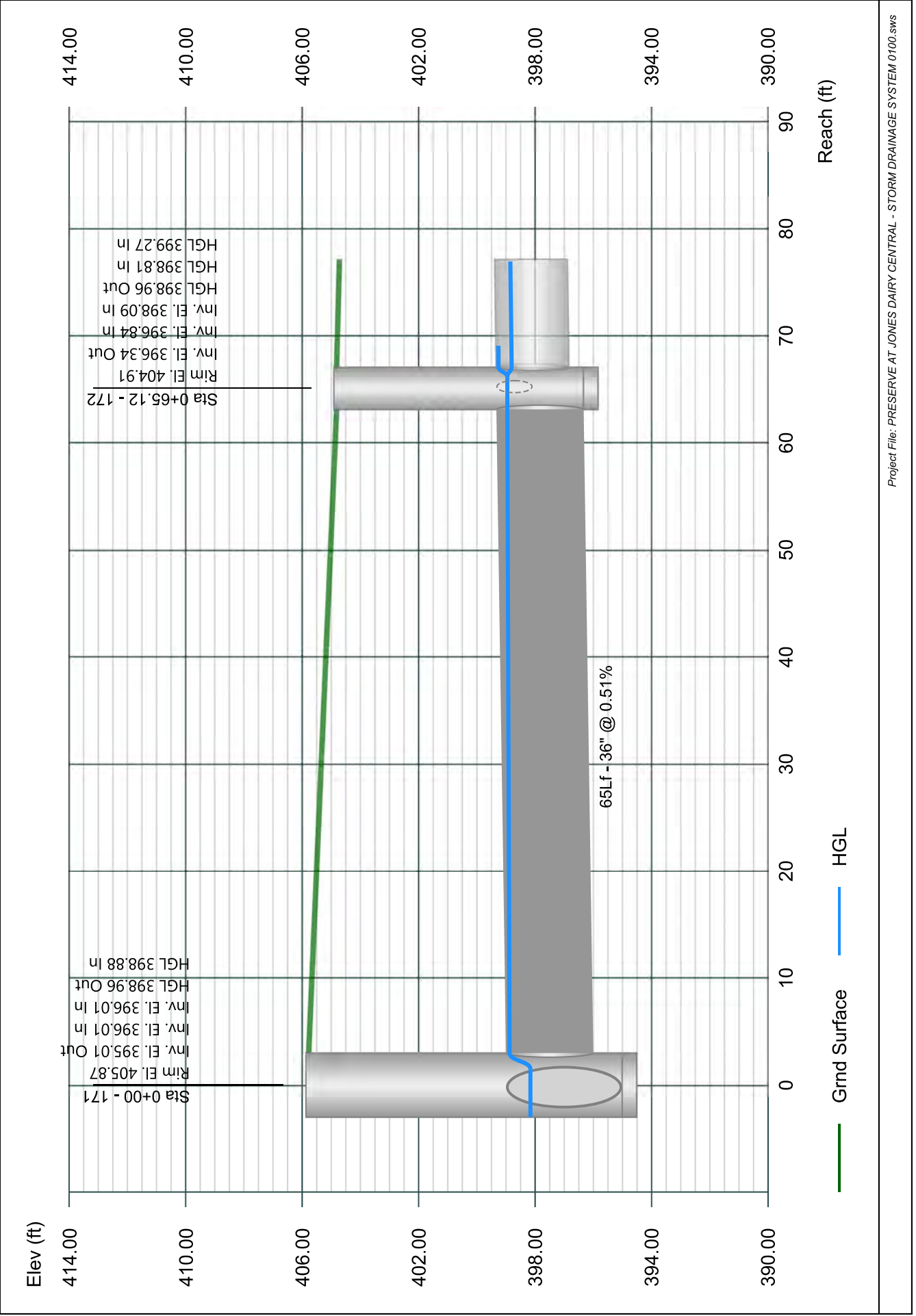

Line 73 - 173 TO 172

Stormwater Studio 2024 v 3.0.0.33

Project Name: Enter Project Name...

01-19-2024

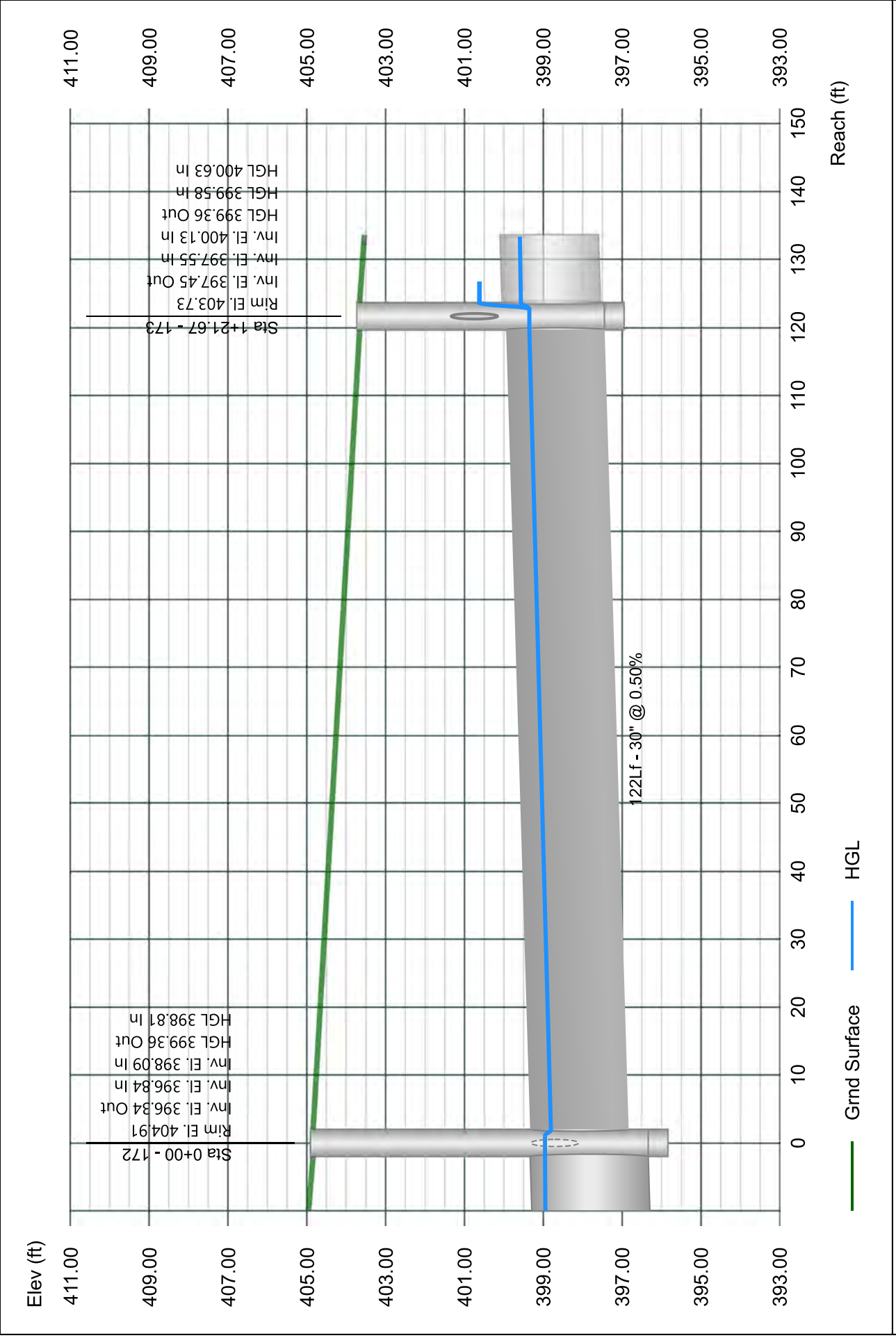

Line 74 - 174 TO 173

Stormwater Studio 2024 v 3.0.0.33

Project Name: Enter Project Name...

01-19-2024

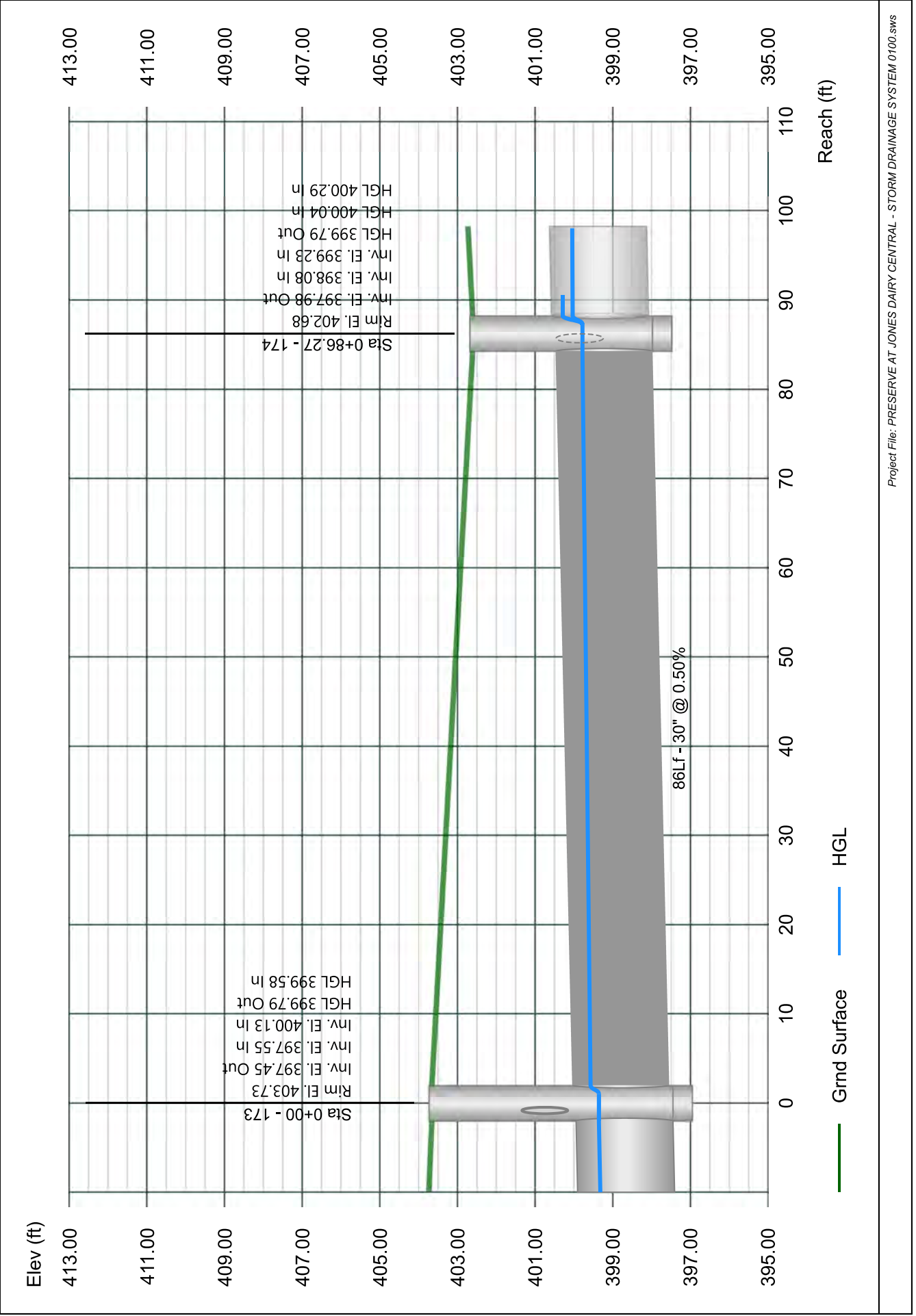

Line 75 - 175 TO 174

Stormwater Studio 2024 v 3.0.0.33

Project Name: Enter Project Name...

01-19-2024

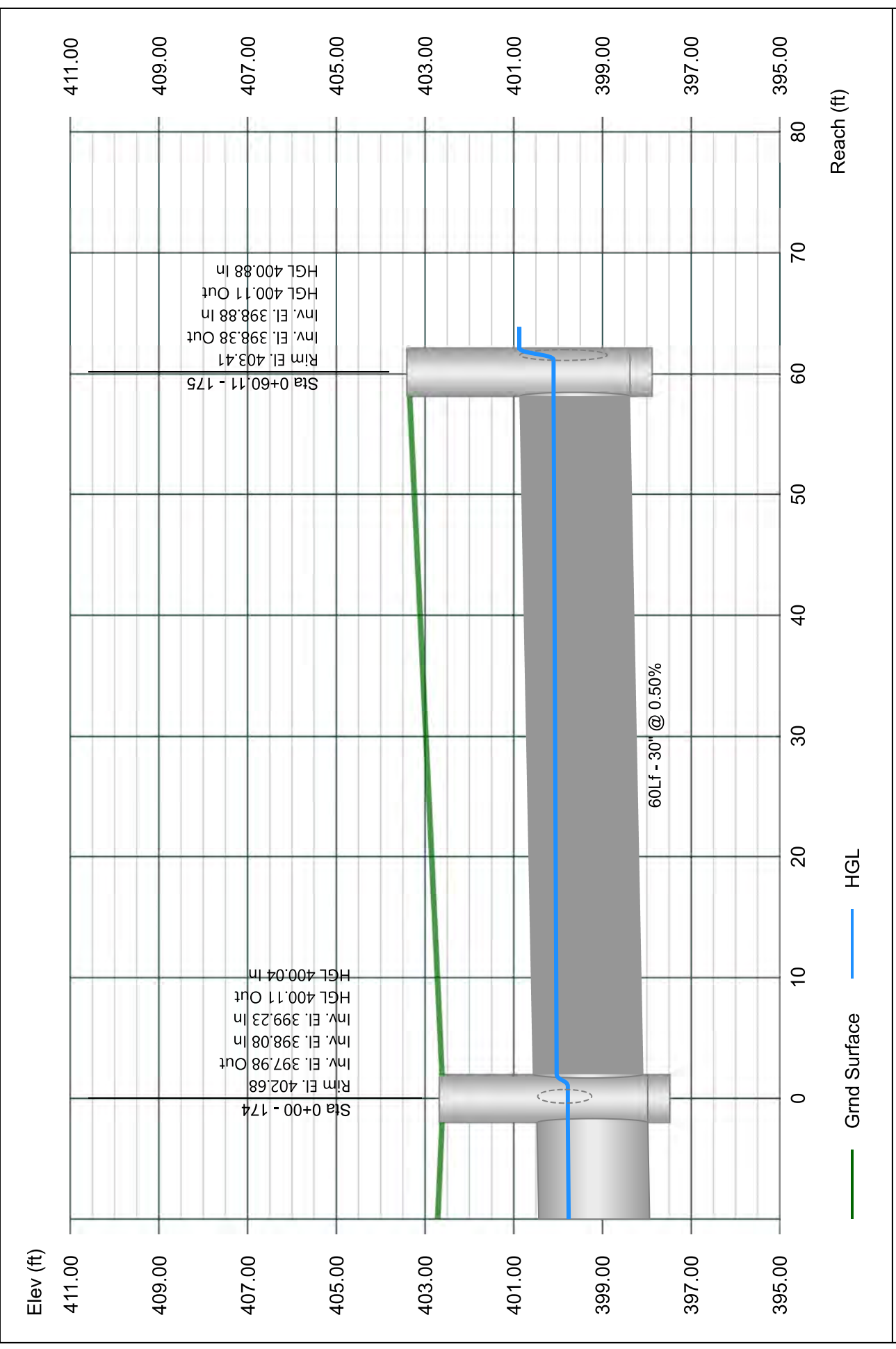

Line 77 - 177 TO 176

Stormwater Studio 2024 v 3.0.0.33

Project Name: Enter Project Name...

01-19-2024

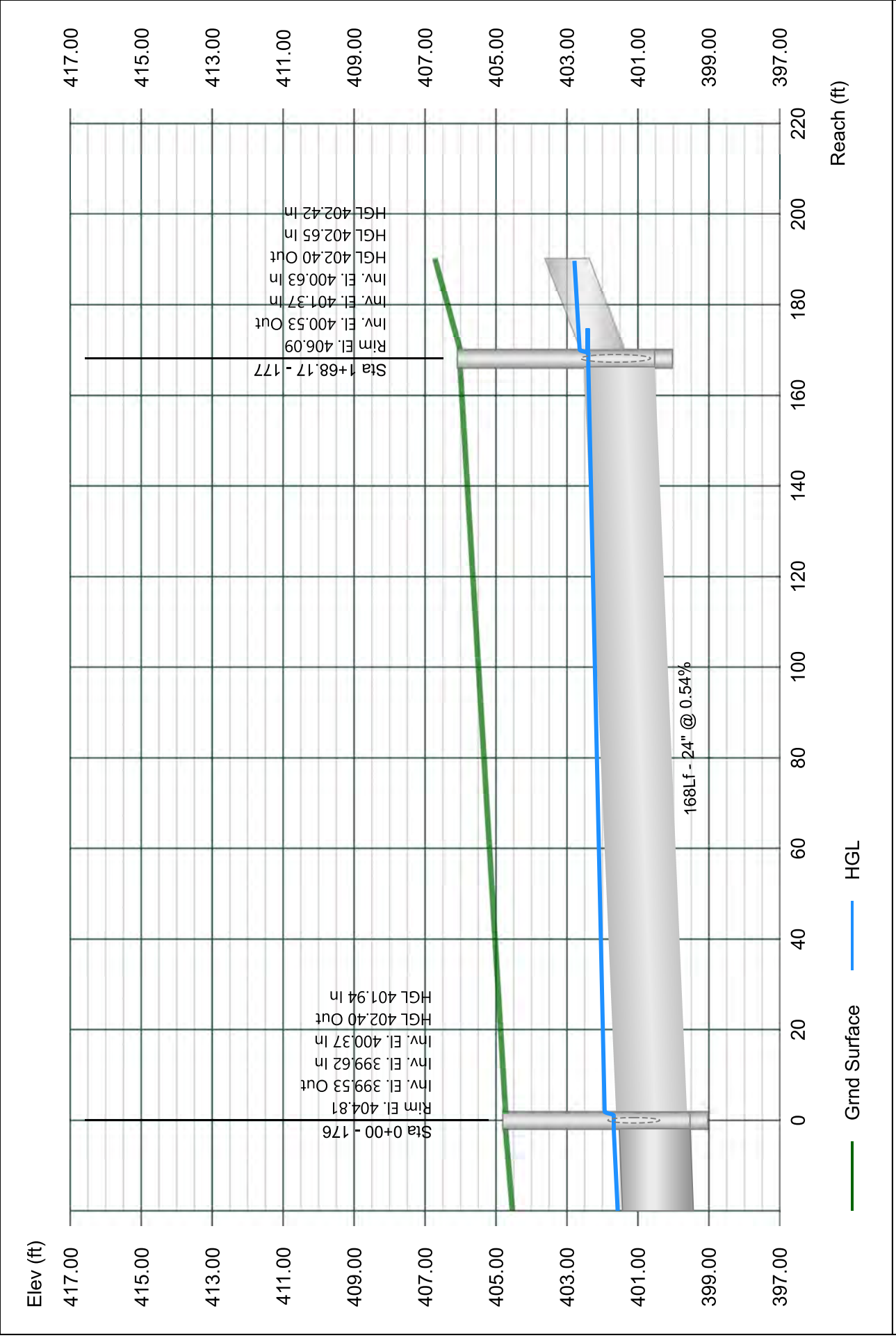

Line 78 - 178 TO 177

Stormwater Studio 2024 v 3.0.0.33

Project Name: Enter Project Name...

01-19-2024

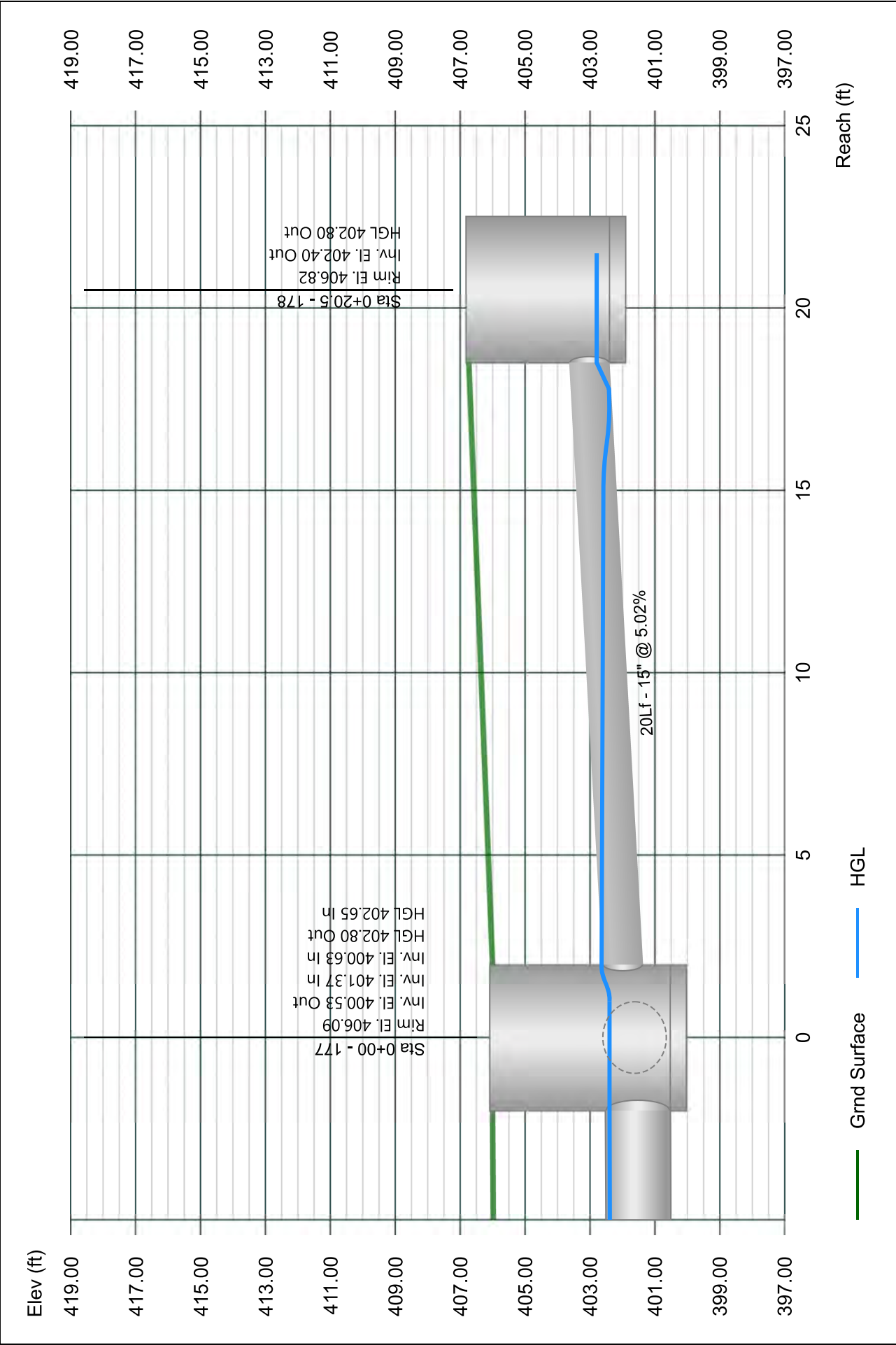

Line 79 - 179 TO 177

Stormwater Studio 2024 v 3.0.0.33

Project Name: Enter Project Name...

01-19-2024

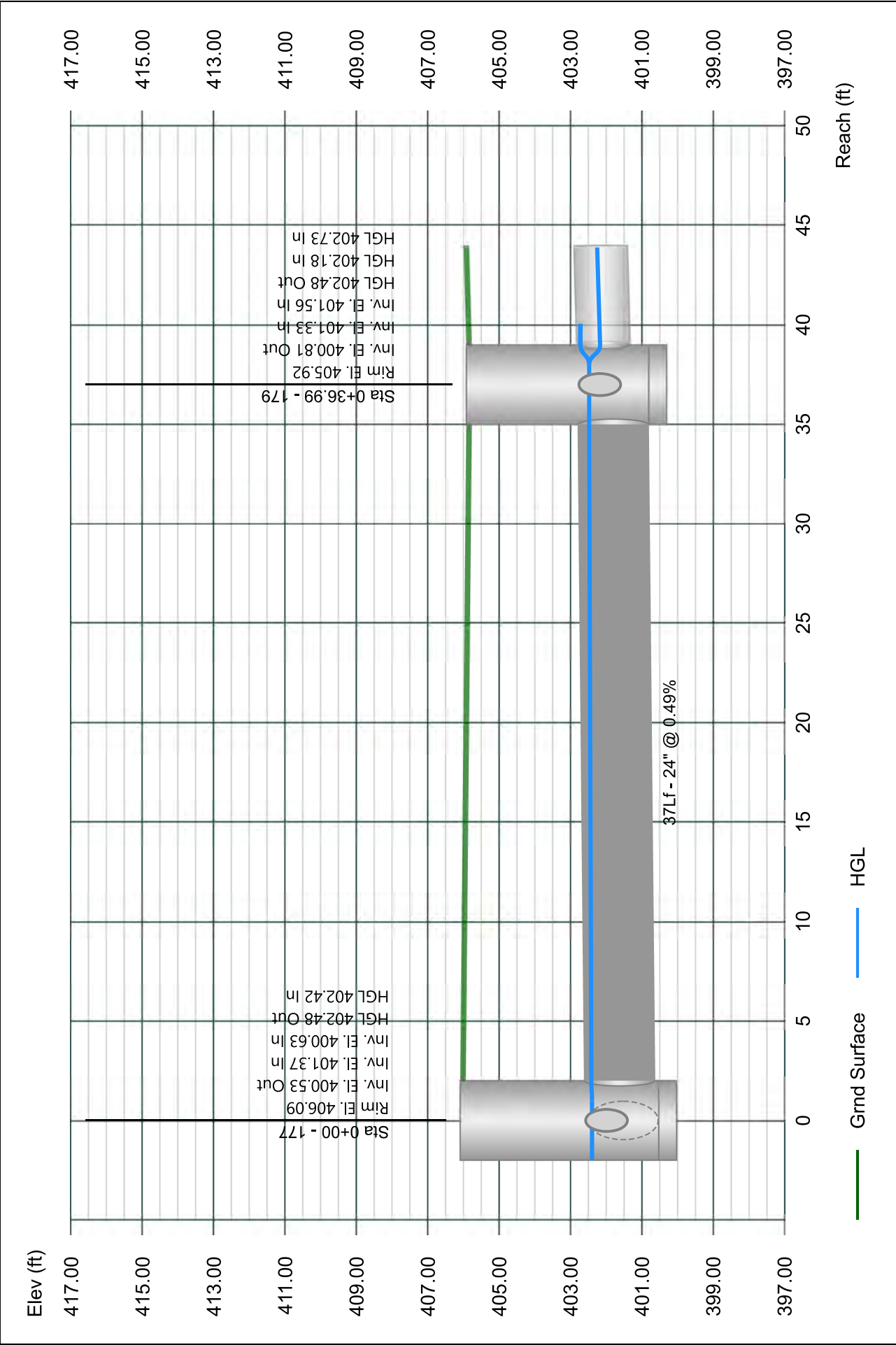

Line 80 - 180 TO 179

Stormwater Studio 2024 v 3.0.0.33

Project Name: Enter Project Name...

01-19-2024

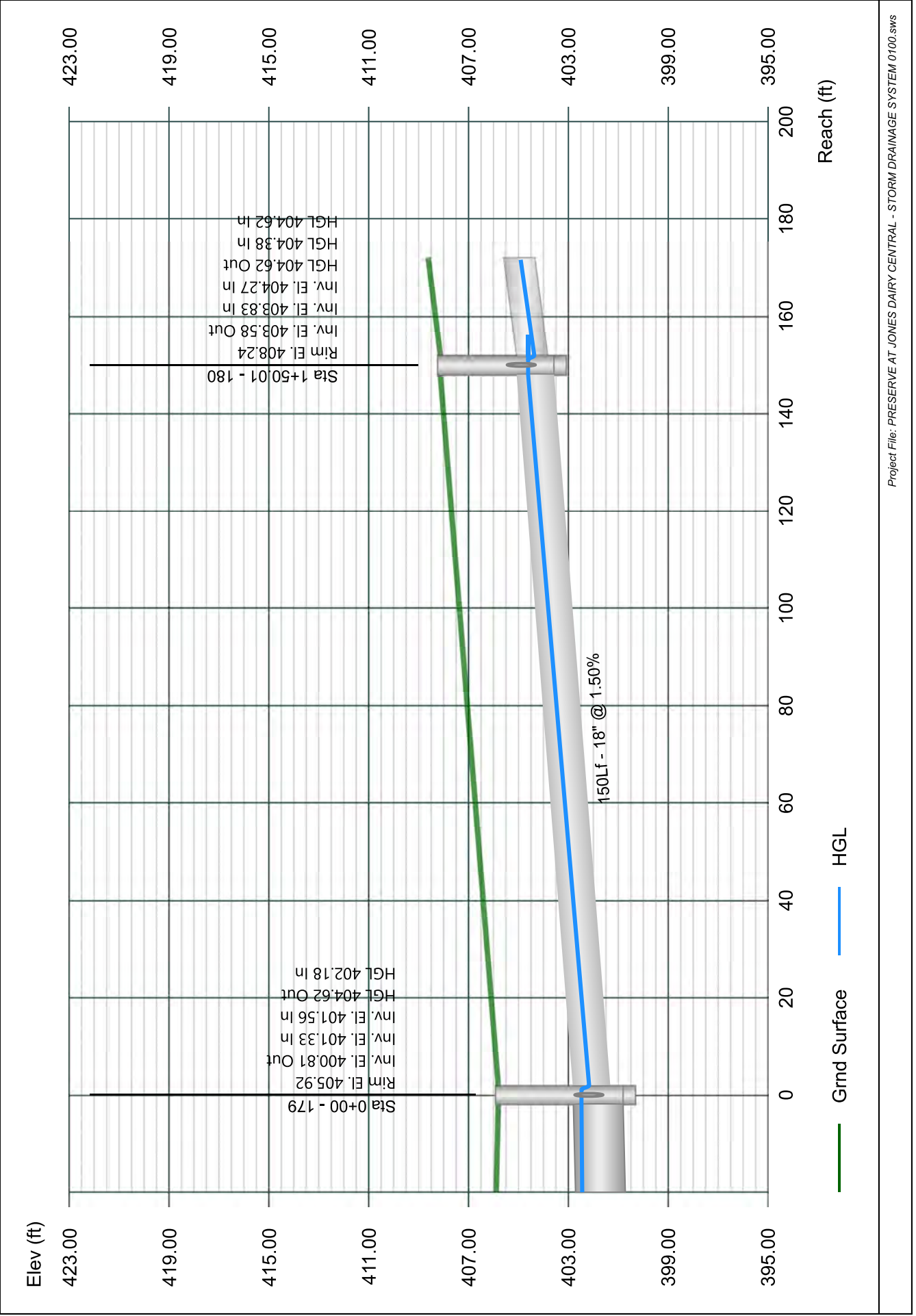

Line 81 - 181 TO 180

Stormwater Studio 2024 v 3.0.0.33

Project Name: Enter Project Name...

01-19-2024

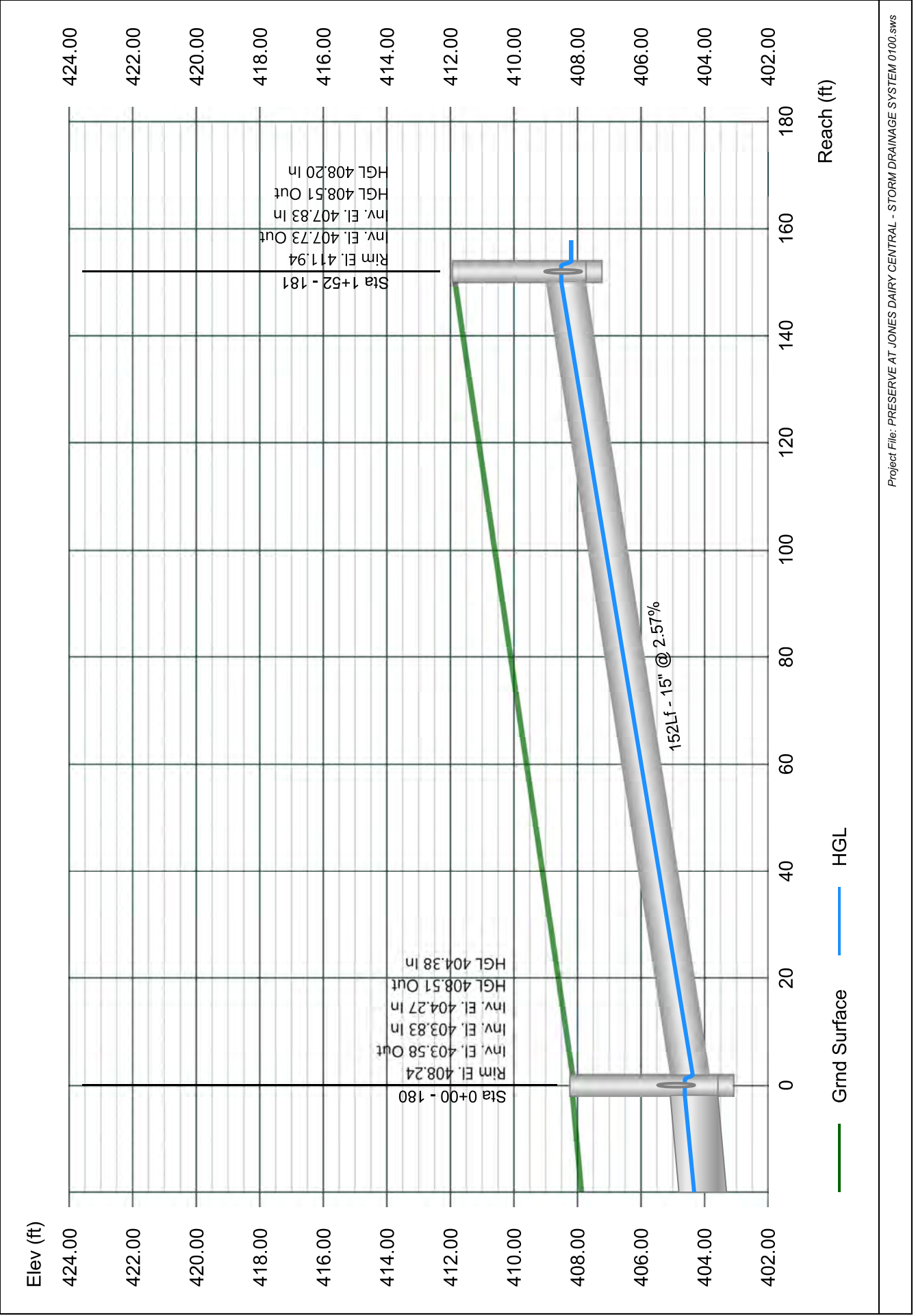

Line 82 - 182 TO 181

Stormwater Studio 2024 v 3.0.0.33

Project Name: Enter Project Name...

01-19-2024

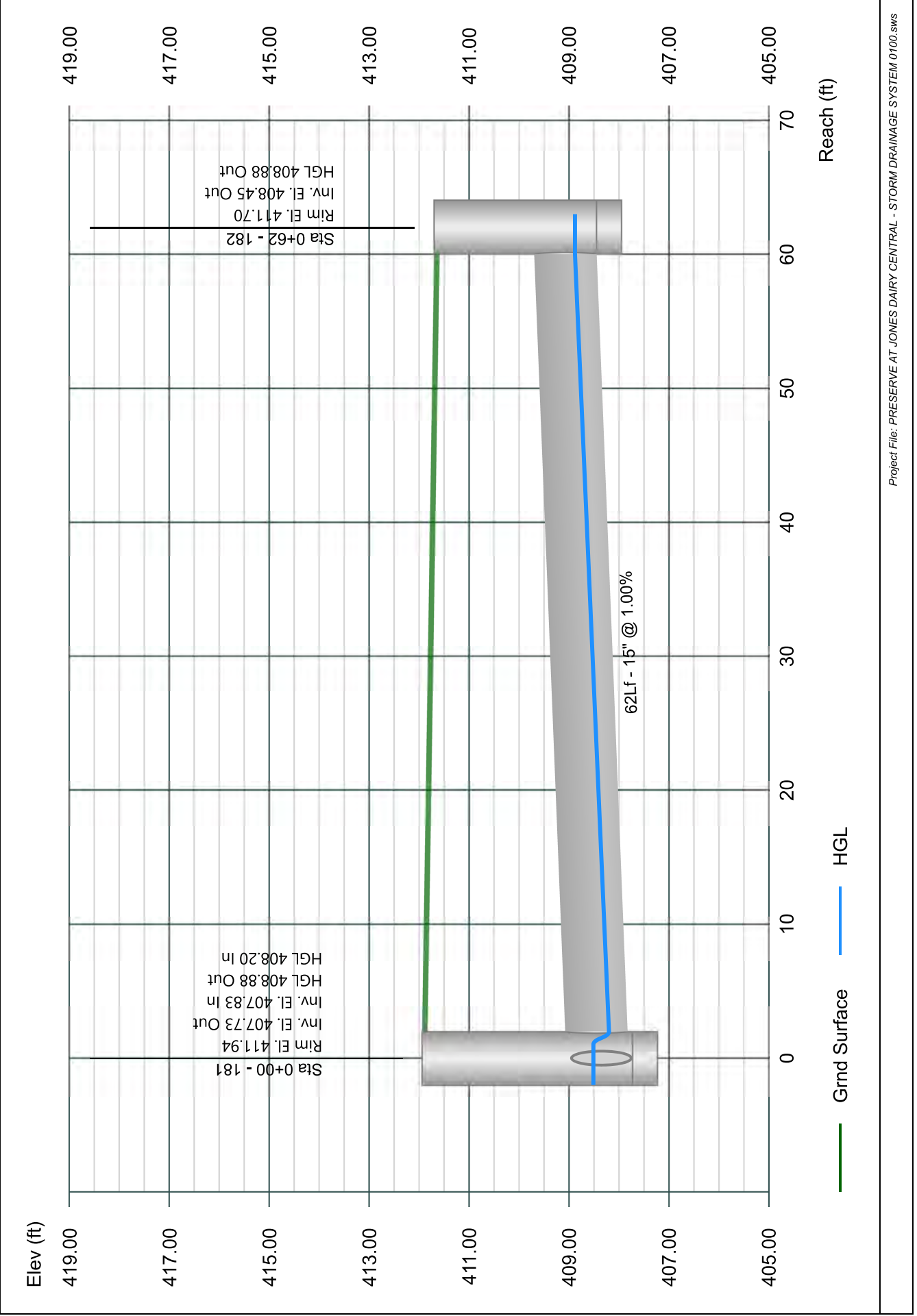

Line 83 - 188 TO 180

Stormwater Studio 2024 v 3.0.0.33

Project Name: Enter Project Name...

01-19-2024

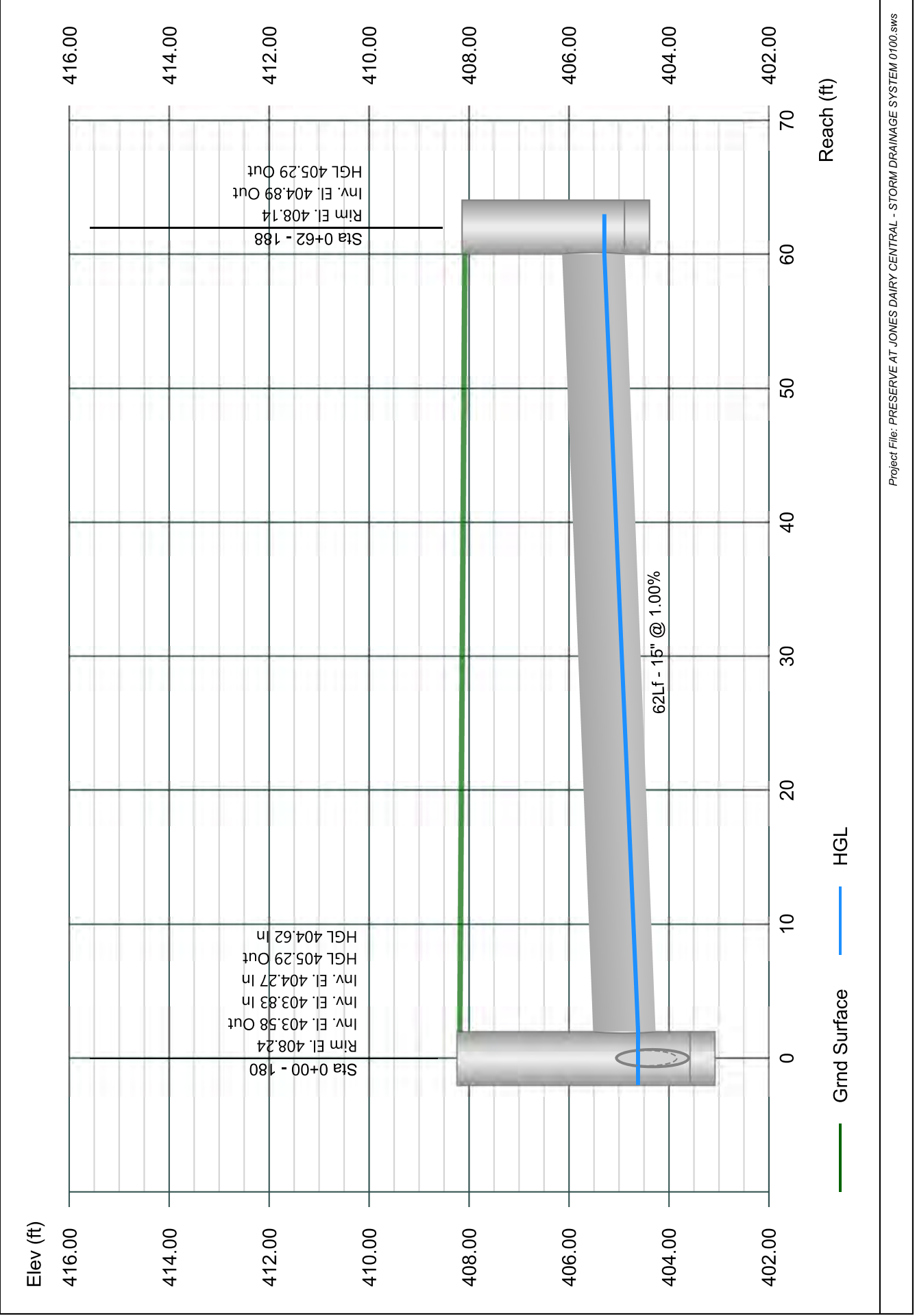

Line 84 - 187 TO 179

Stormwater Studio 2024 v 3.0.0.33

Project Name: Enter Project Name...

01-19-2024

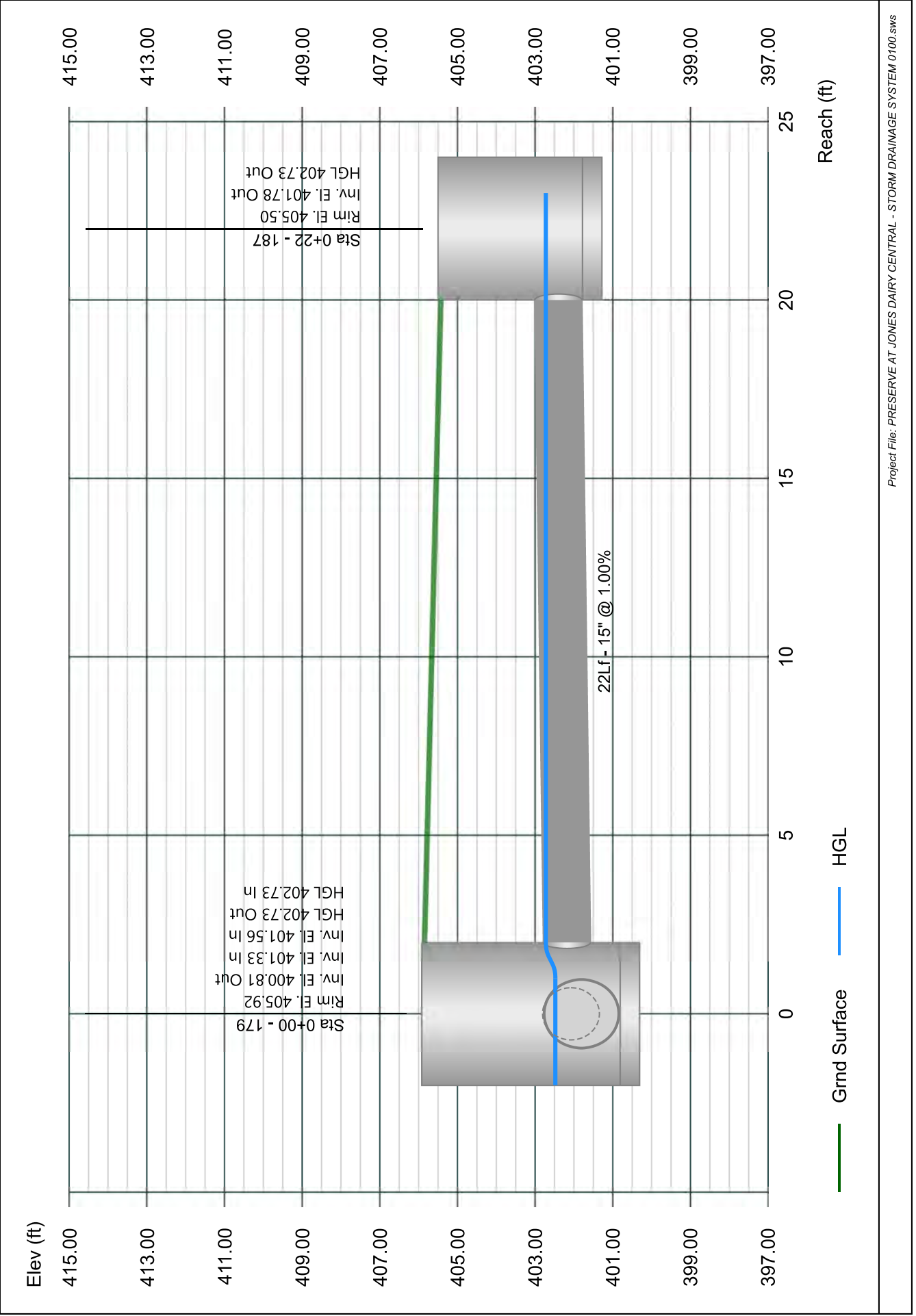

Line 85 - 186 TO 176

Stormwater Studio 2024 v 3.0.0.33

Project Name: Enter Project Name...

01-19-2024

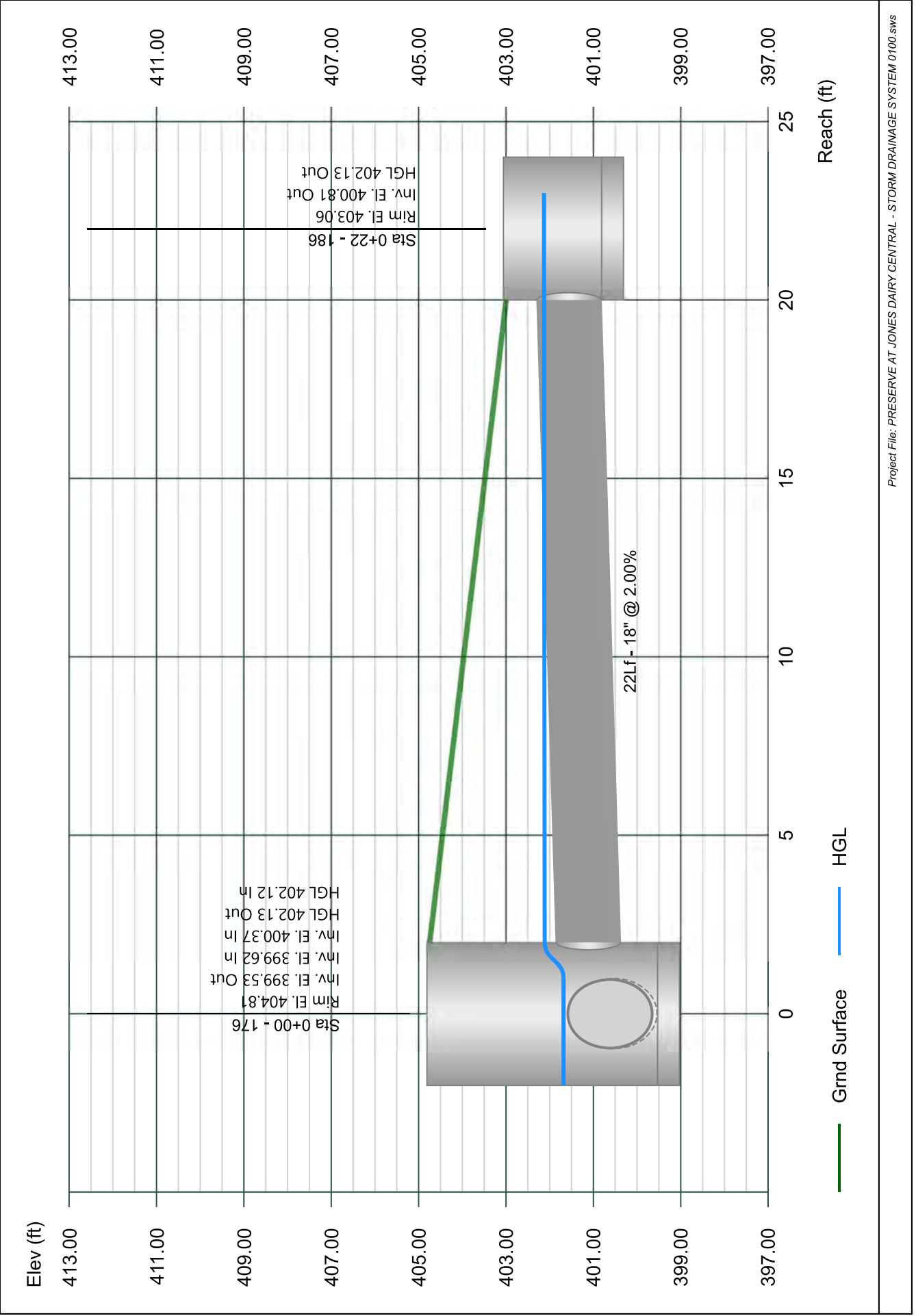

Line 86 - 185 TO 174

Stormwater Studio 2024 v 3.0.0.33

Project Name: Enter Project Name...

01-19-2024

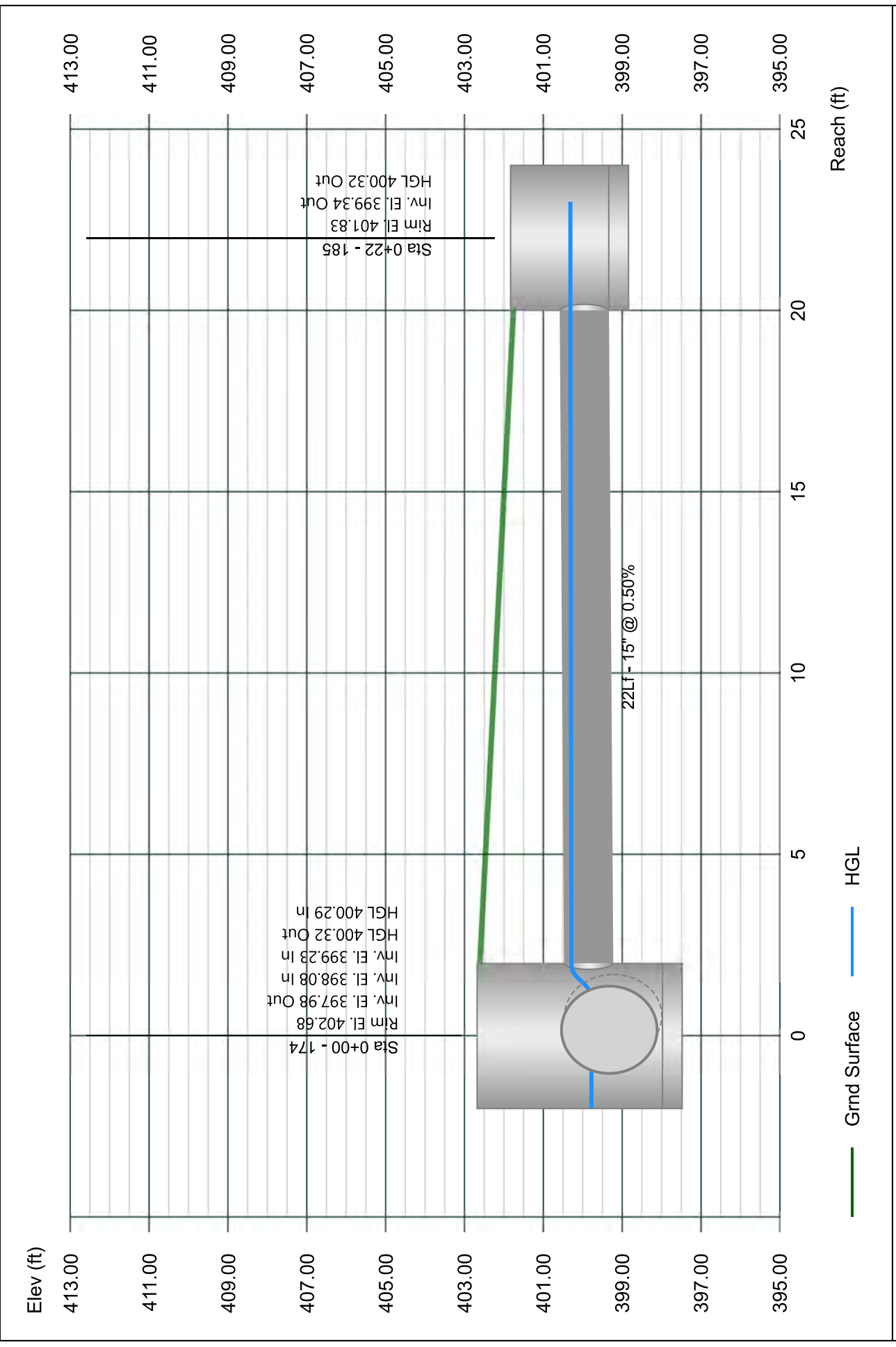

Line 87 - 184 TO 173

Stormwater Studio 2024 v 3.0.0.33

Project Name: Enter Project Name...

01-19-2024

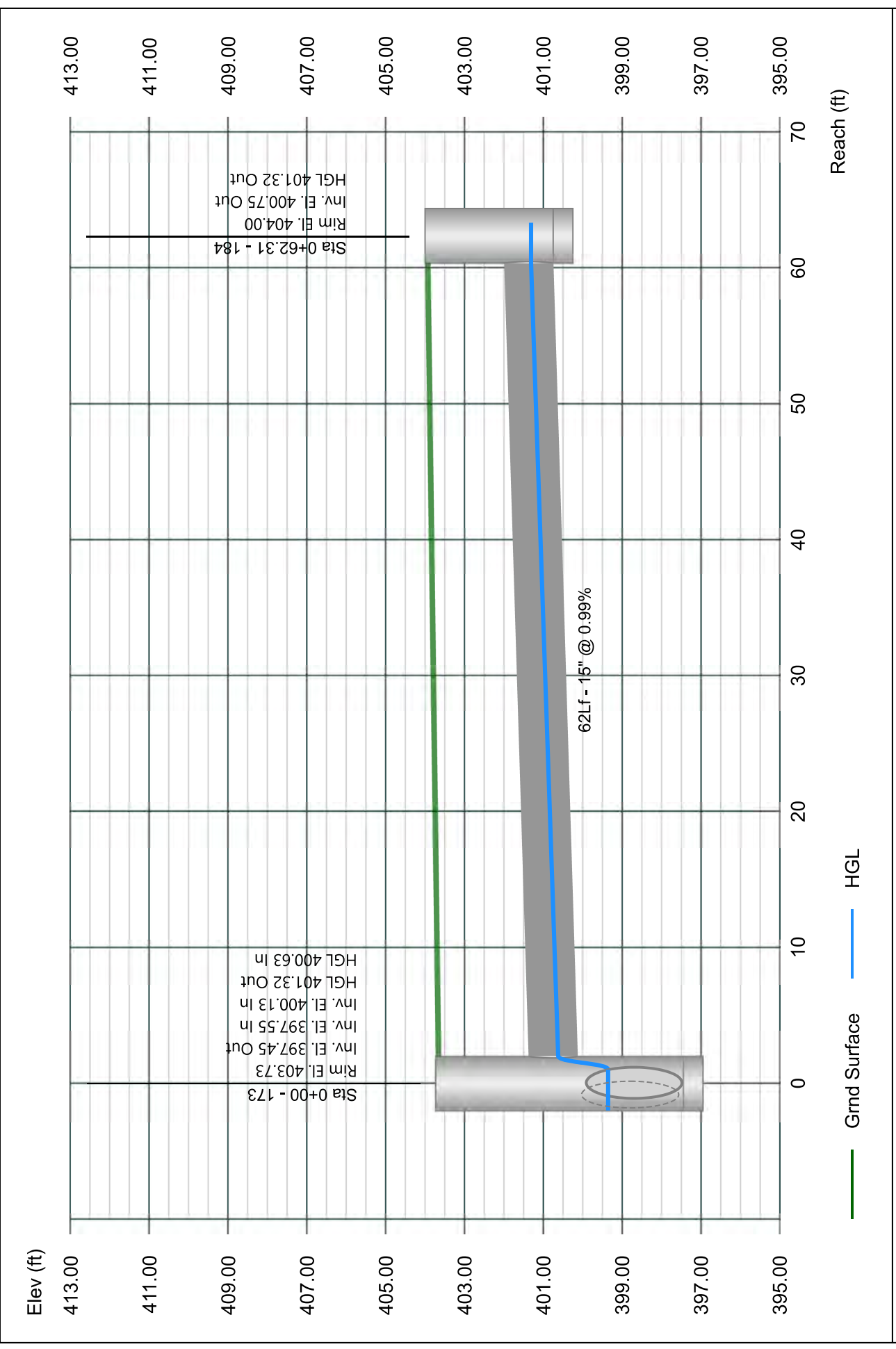

Line 88 - 183 TO 172

Stormwater Studio 2024 v 3.0.0.33

Project Name: Enter Project Name...

01-19-2024

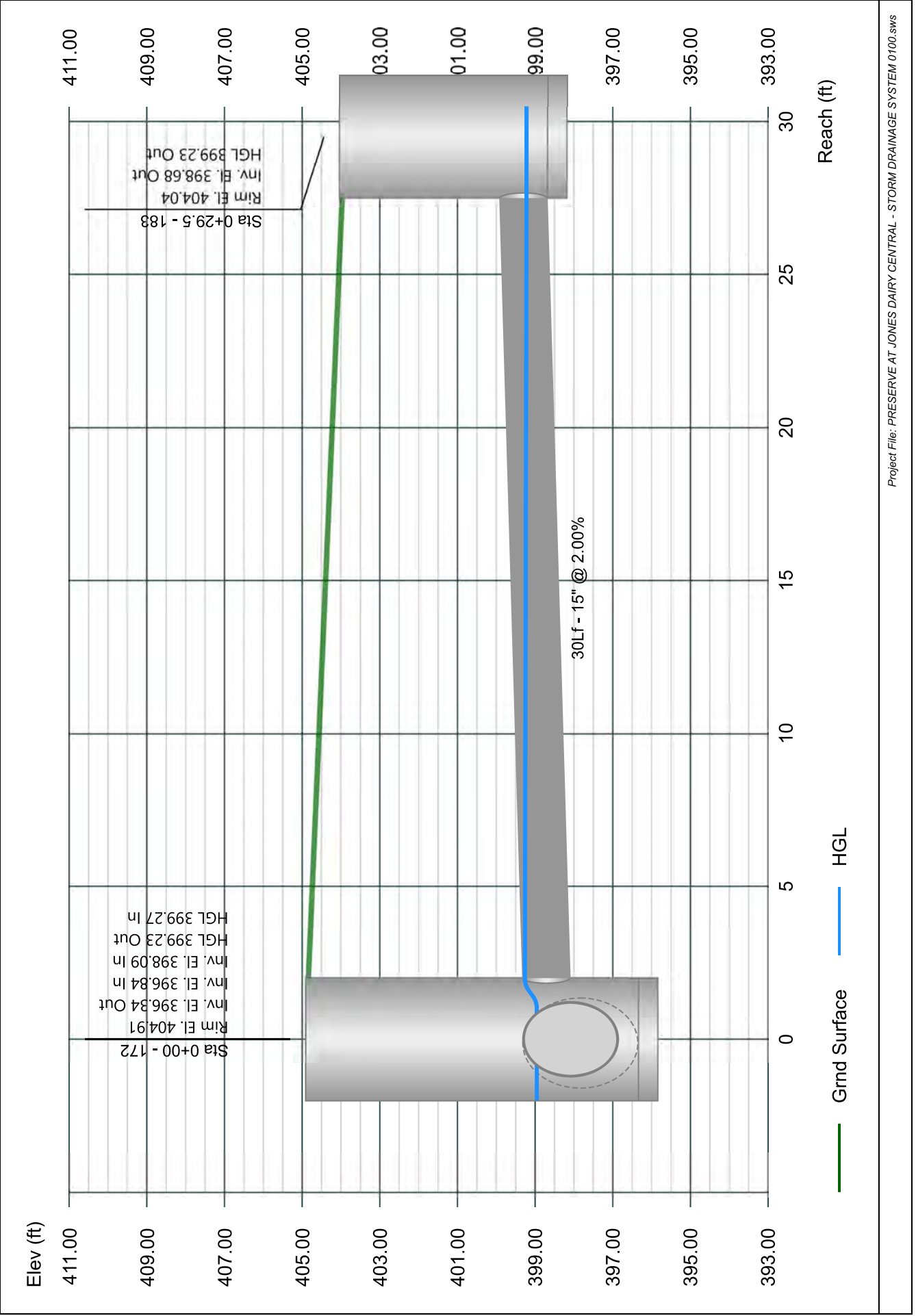

Line 89 - 189 TO 171

Stormwater Studio 2024 v 3.0.0.33

Project Name: Enter Project Name...

01-19-2024

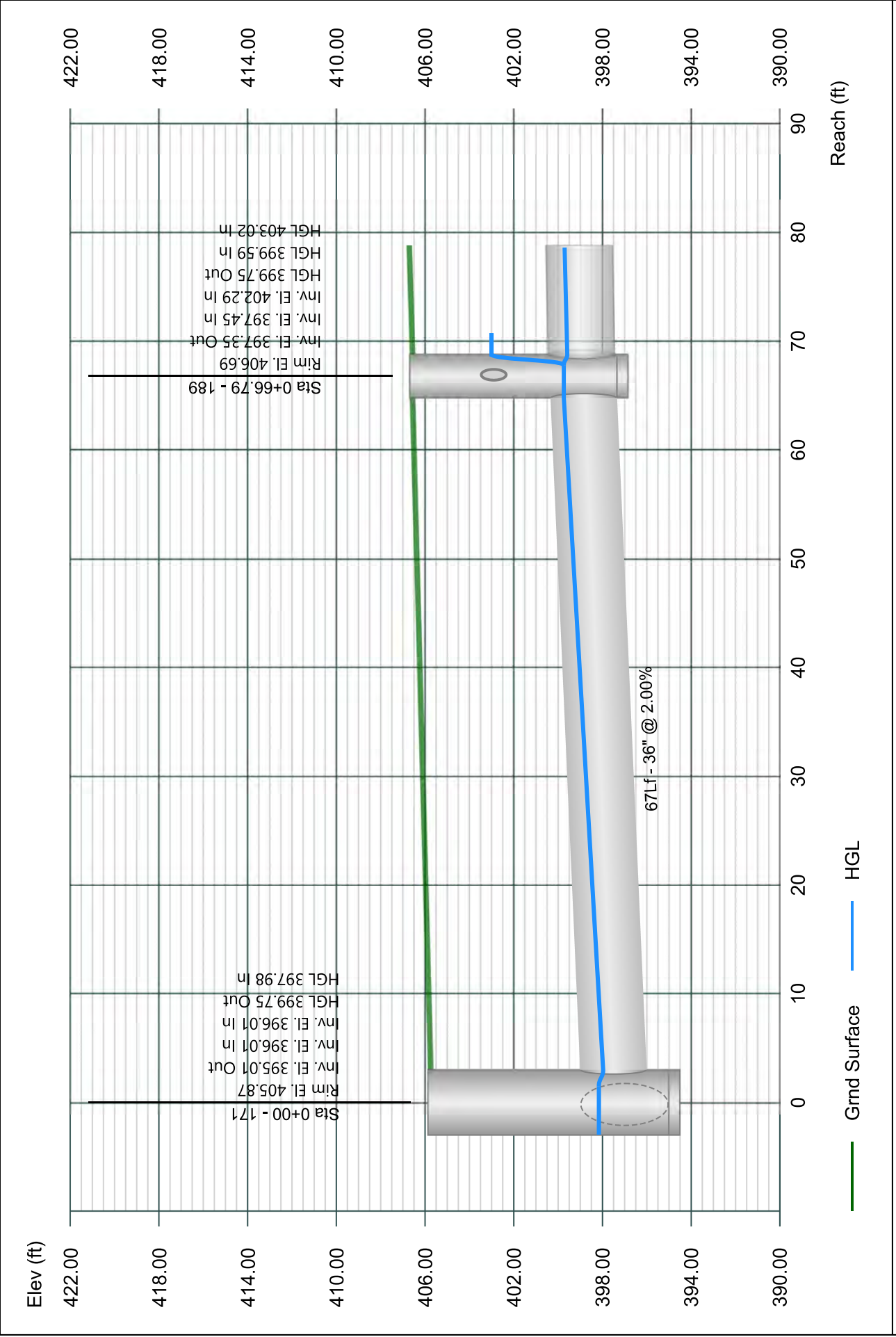

Line 90 - 190 TO 189

Stormwater Studio 2024 v 3.0.0.33

Project Name: Enter Project Name...

01-19-2024

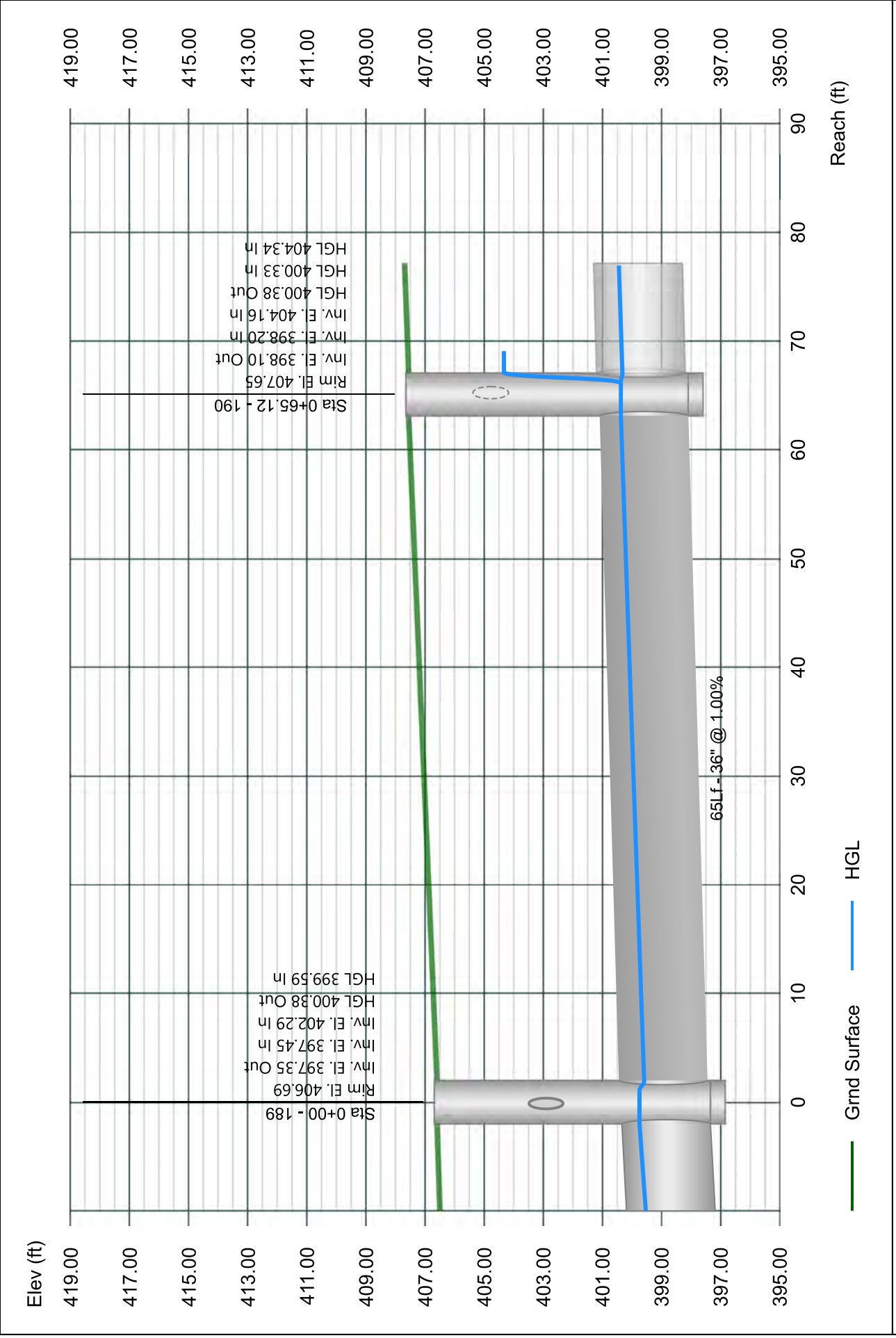

Line 91 - 191 TO 190

Stormwater Studio 2024 v 3.0.0.33

Project Name: Enter Project Name...

01-19-2024

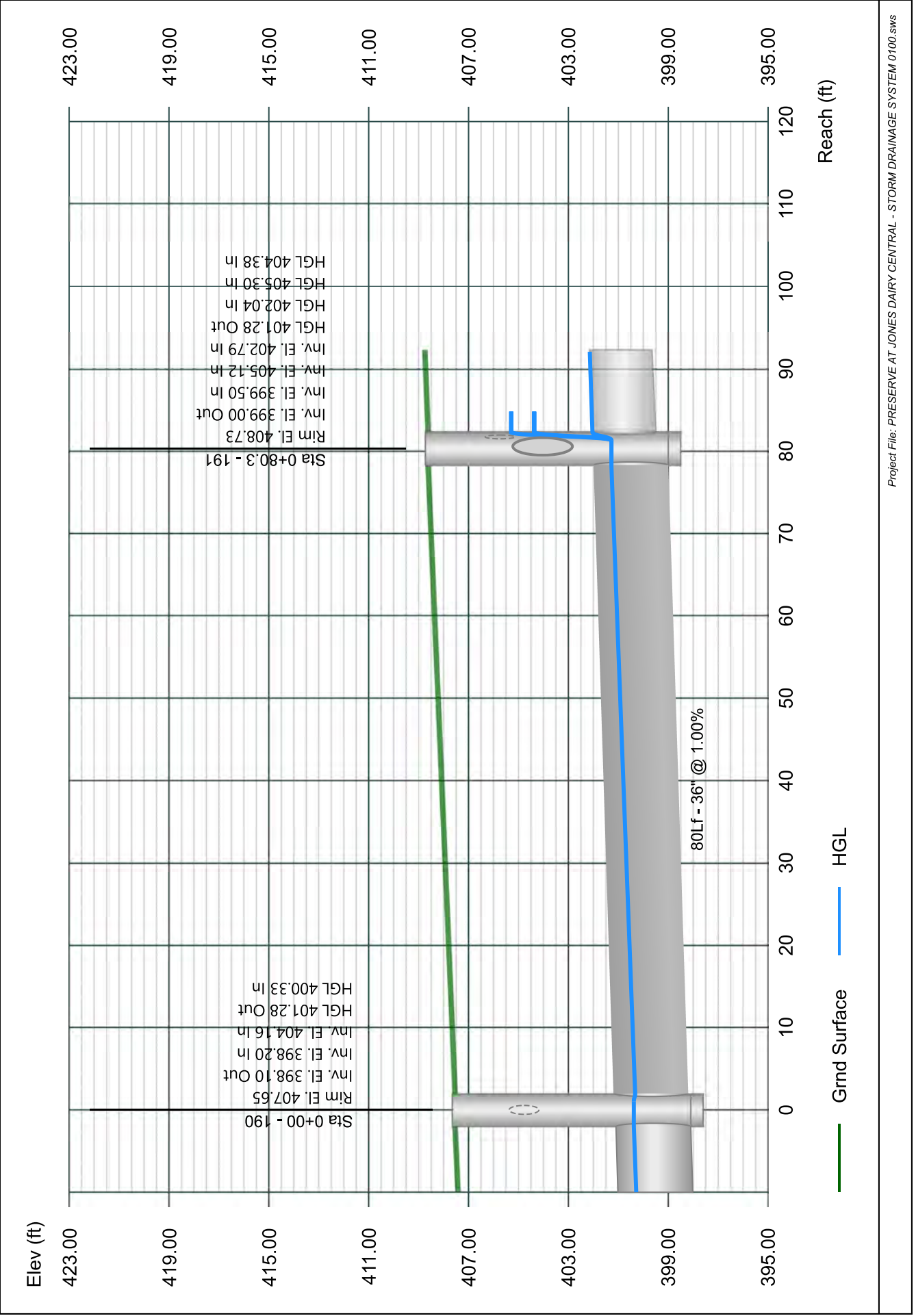

Line 92 - 192 TO 191

Stormwater Studio 2024 v 3.0.0.33

Project Name: Enter Project Name...

01-19-2024

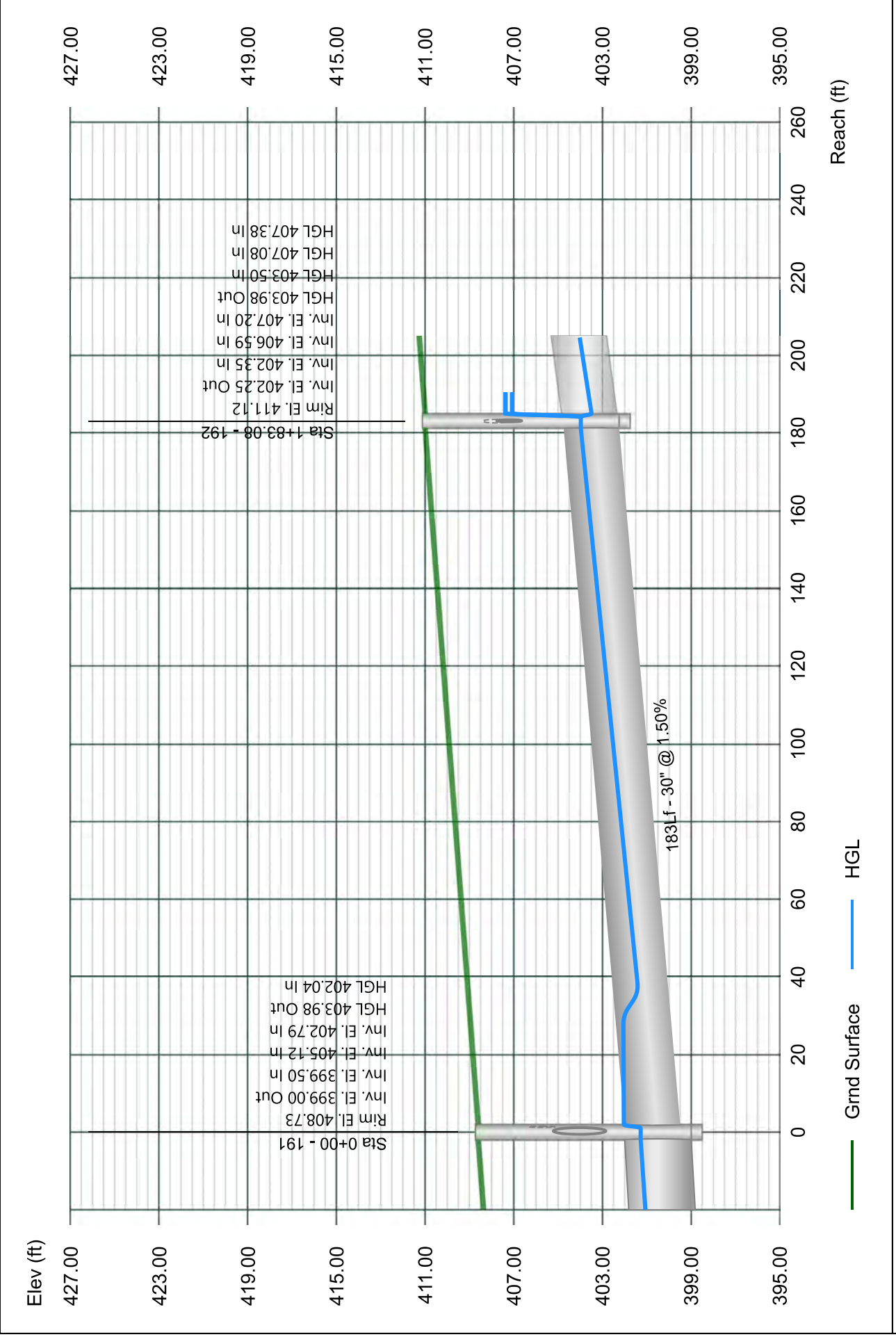

Line 93 - 193 TO 192

Stormwater Studio 2024 v 3.0.0.33

Project Name: Enter Project Name...

01-19-2024

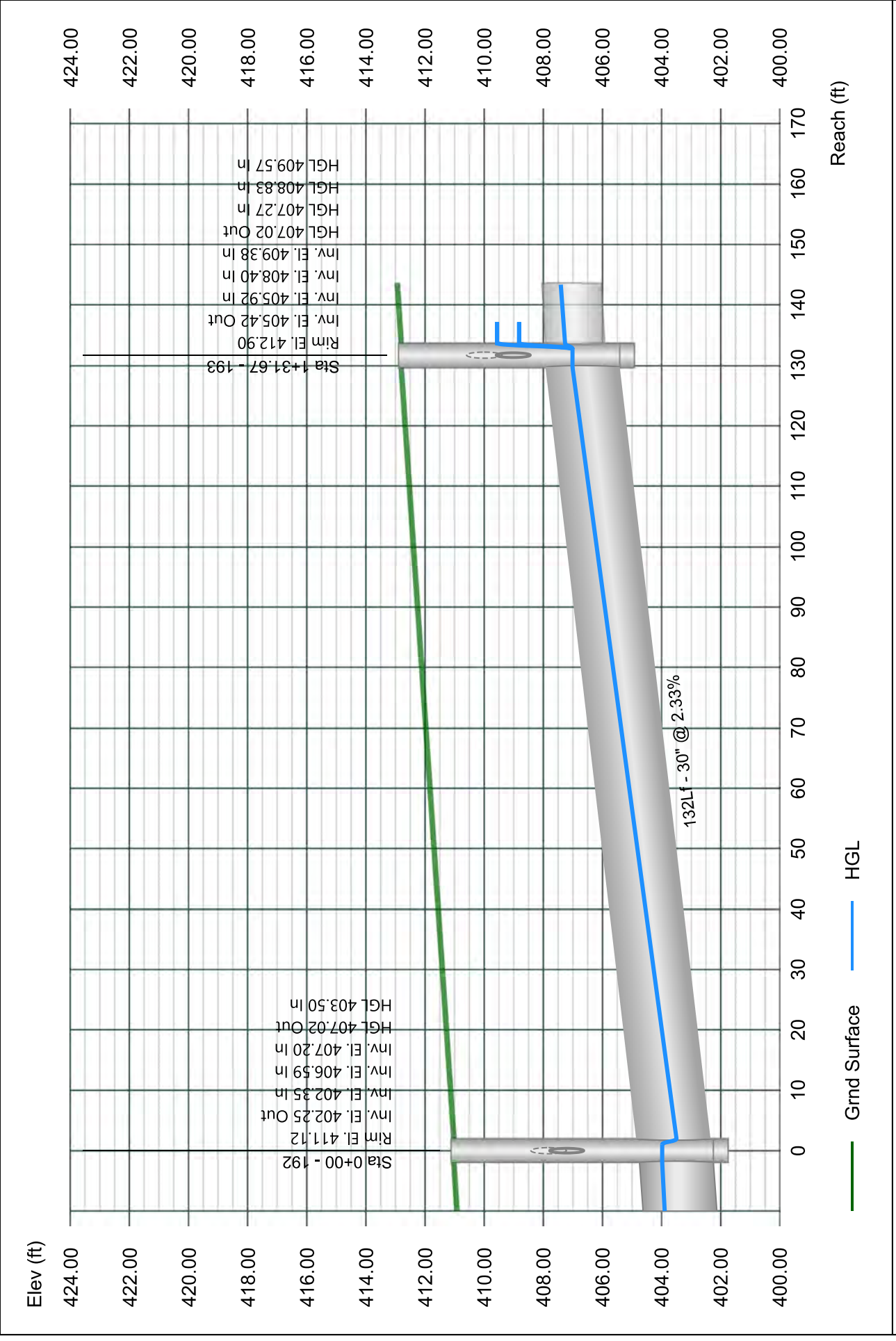

Line 94 - 194 TO 193

Stormwater Studio 2024 v 3.0.0.33

Project Name: Enter Project Name...

01-19-2024

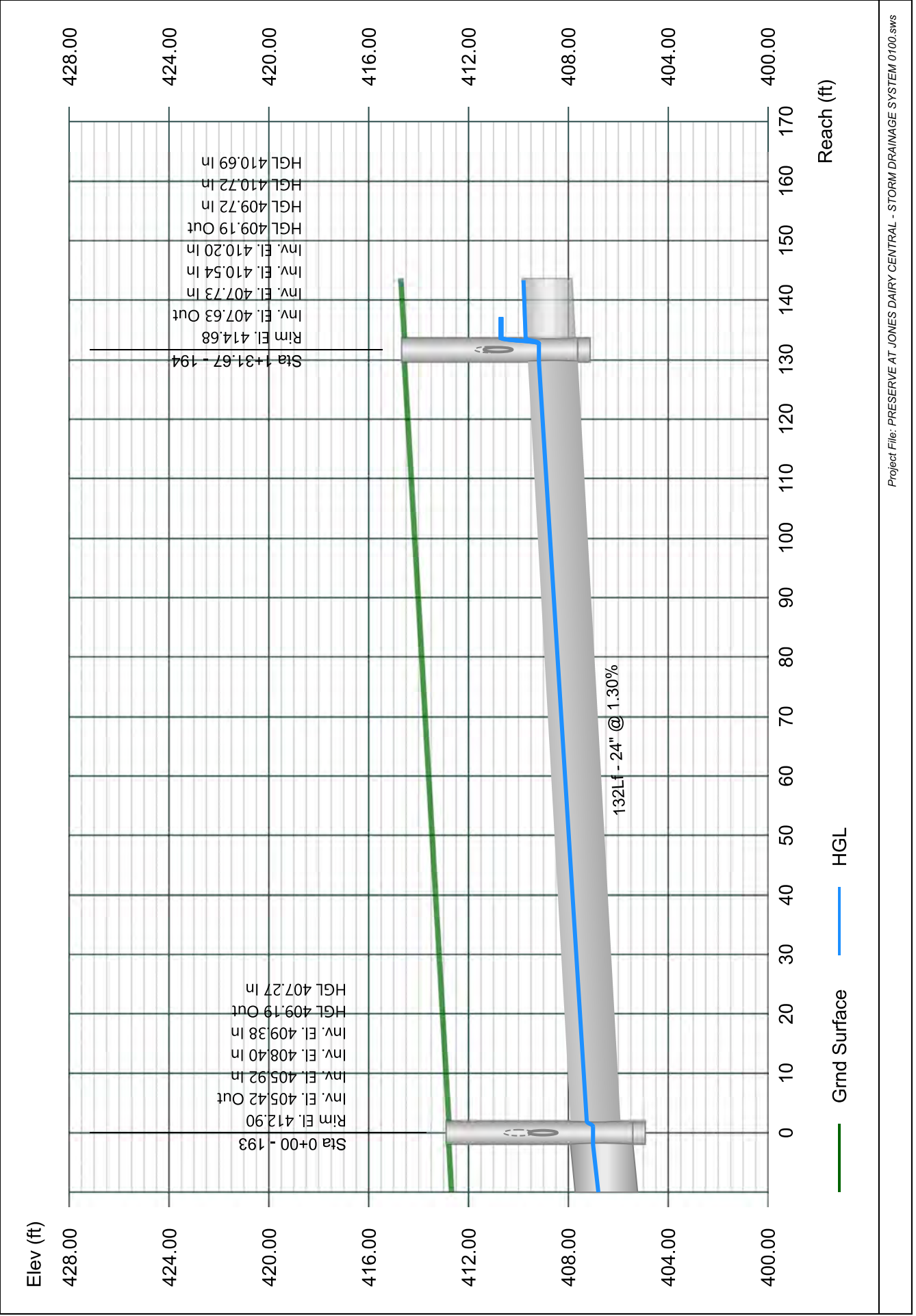

Line 95 - 195 TO 194

Stormwater Studio 2024 v 3.0.0.33

Project Name: Enter Project Name...

01-19-2024

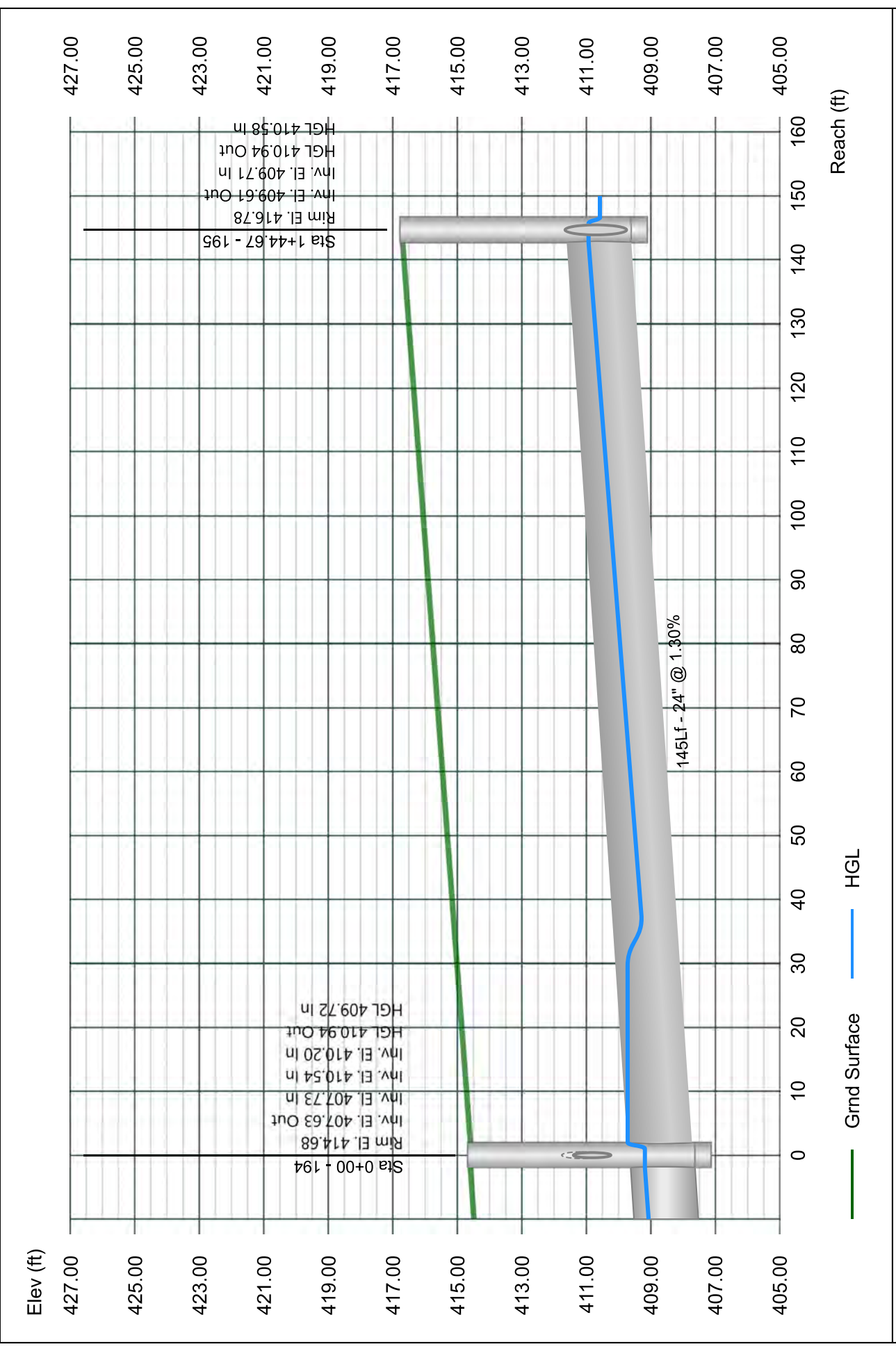

Line 96 - 196 TO 195

Stormwater Studio 2024 v 3.0.0.33

Project Name: Enter Project Name...

01-19-2024

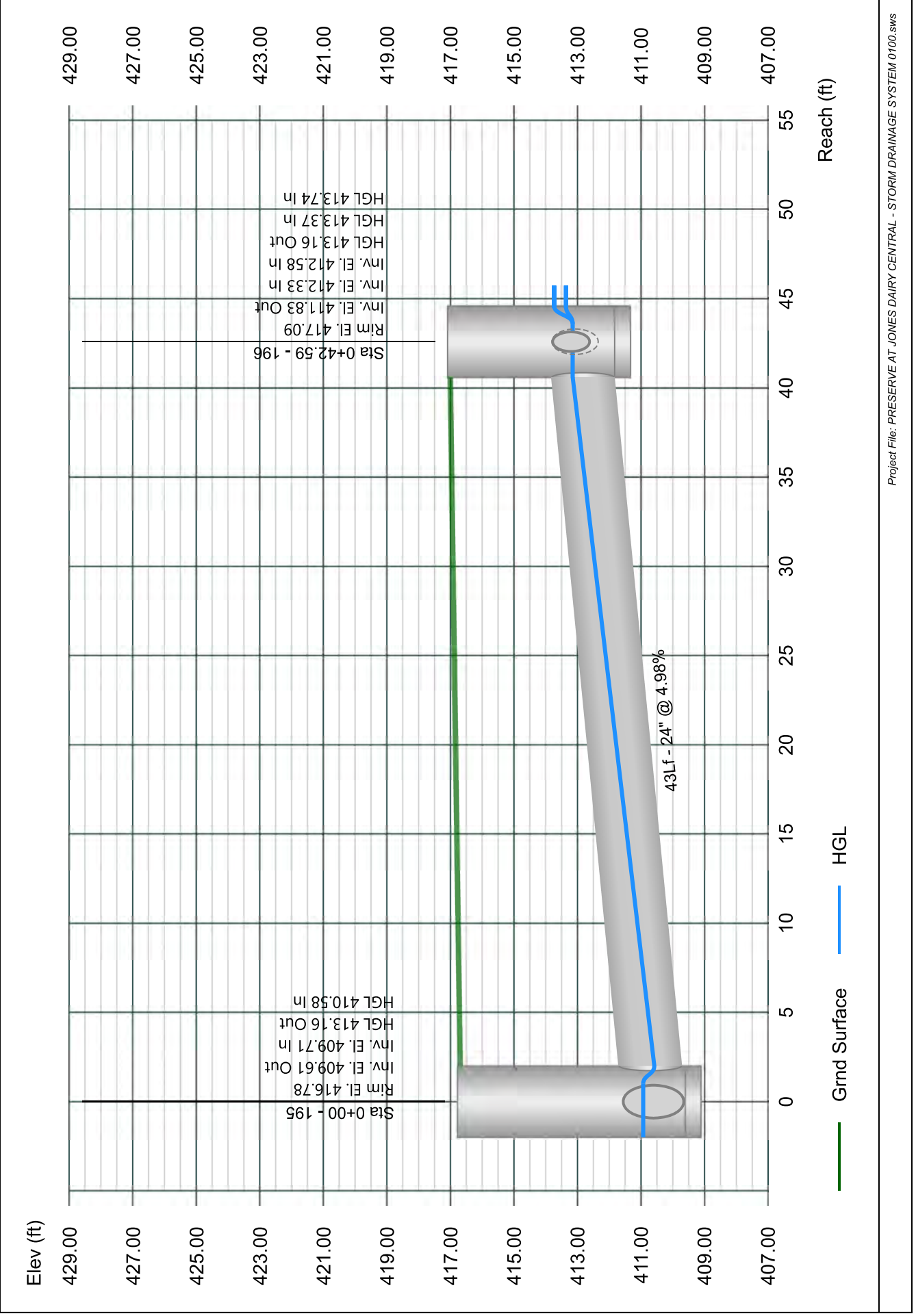

Line 97 - 197 TO 196

Stormwater Studio 2024 v 3.0.0.33

Project Name: Enter Project Name...

01-19-2024

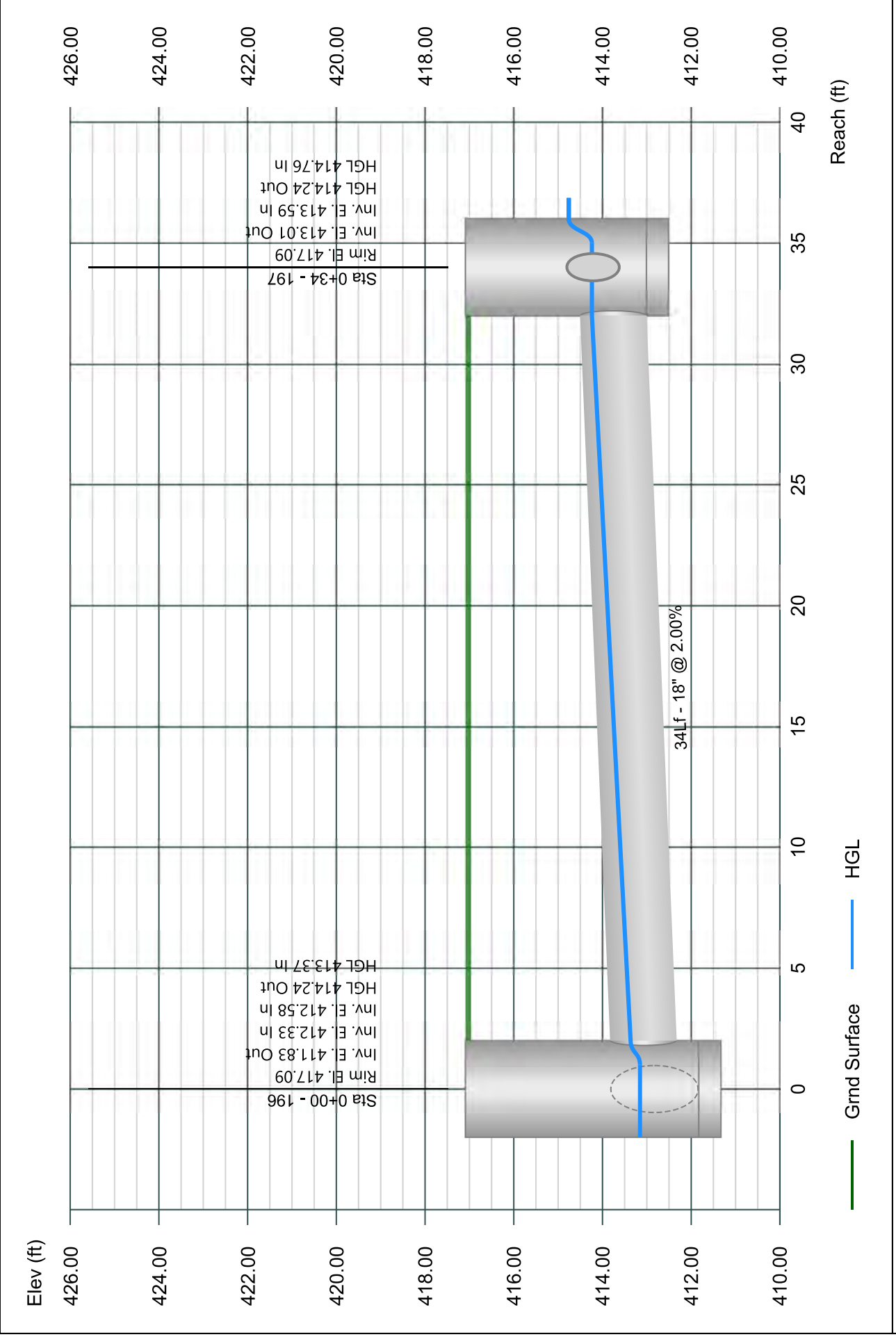

Line 98 - 198 TO 197

Stormwater Studio 2024 v 3.0.0.33

Project Name: Enter Project Name...

01-19-2024

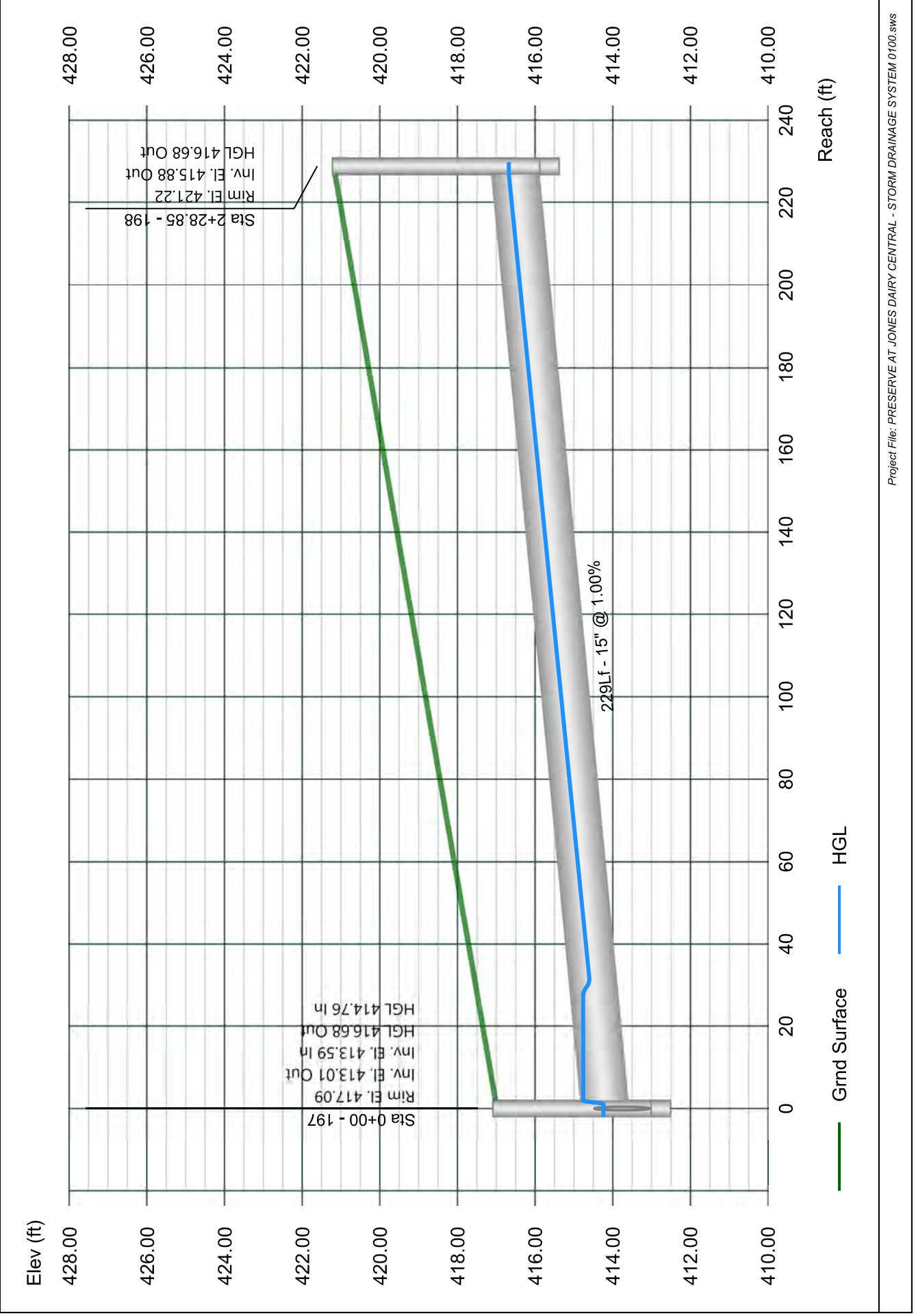

Line 99 - 199 TO 196

Stormwater Studio 2024 v 3.0.0.33

Project Name: Enter Project Name...

01-19-2024

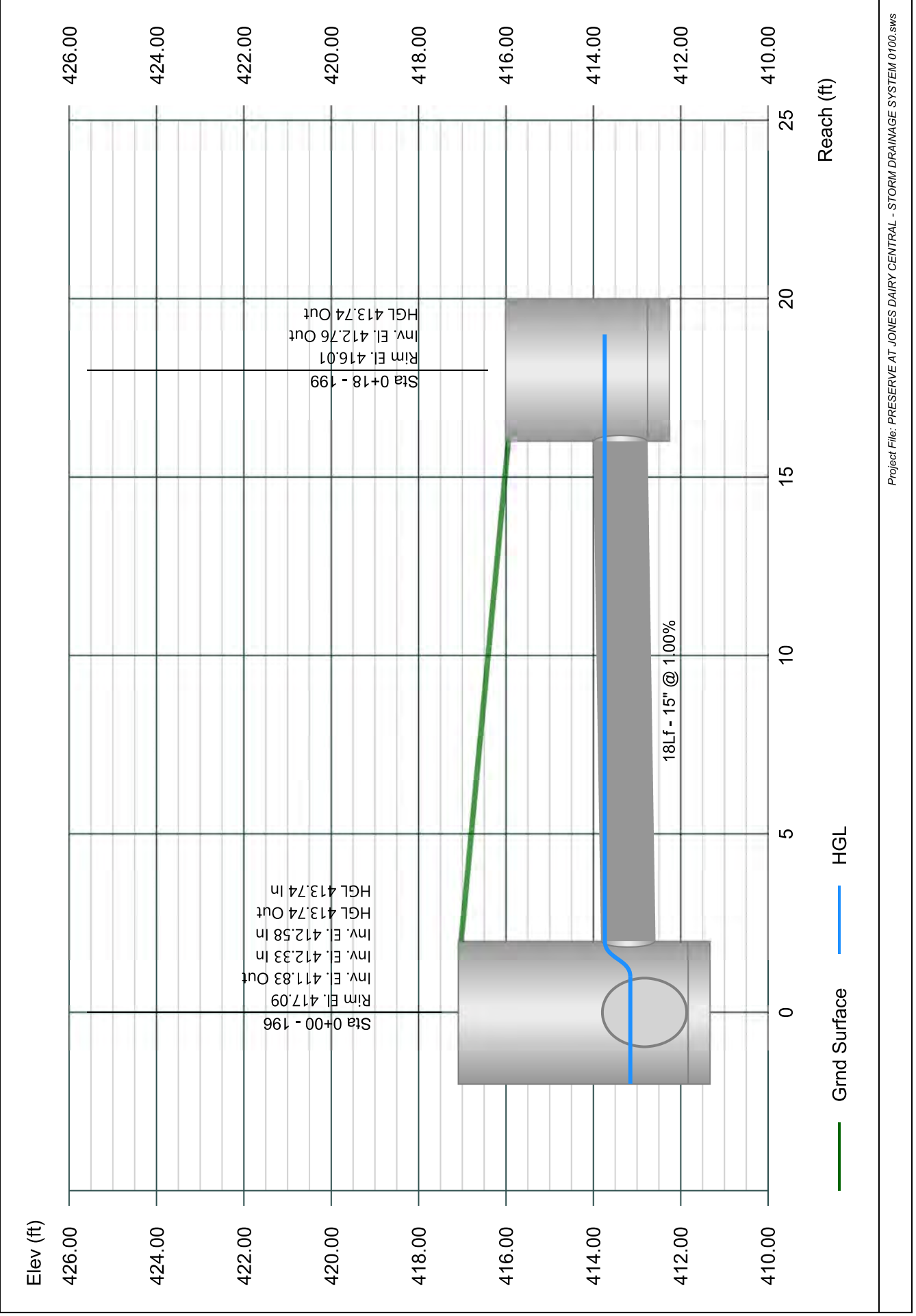

Line 100 - 200 TO 194

Stormwater Studio 2024 v 3.0.0.33

Project Name: Enter Project Name...

01-19-2024

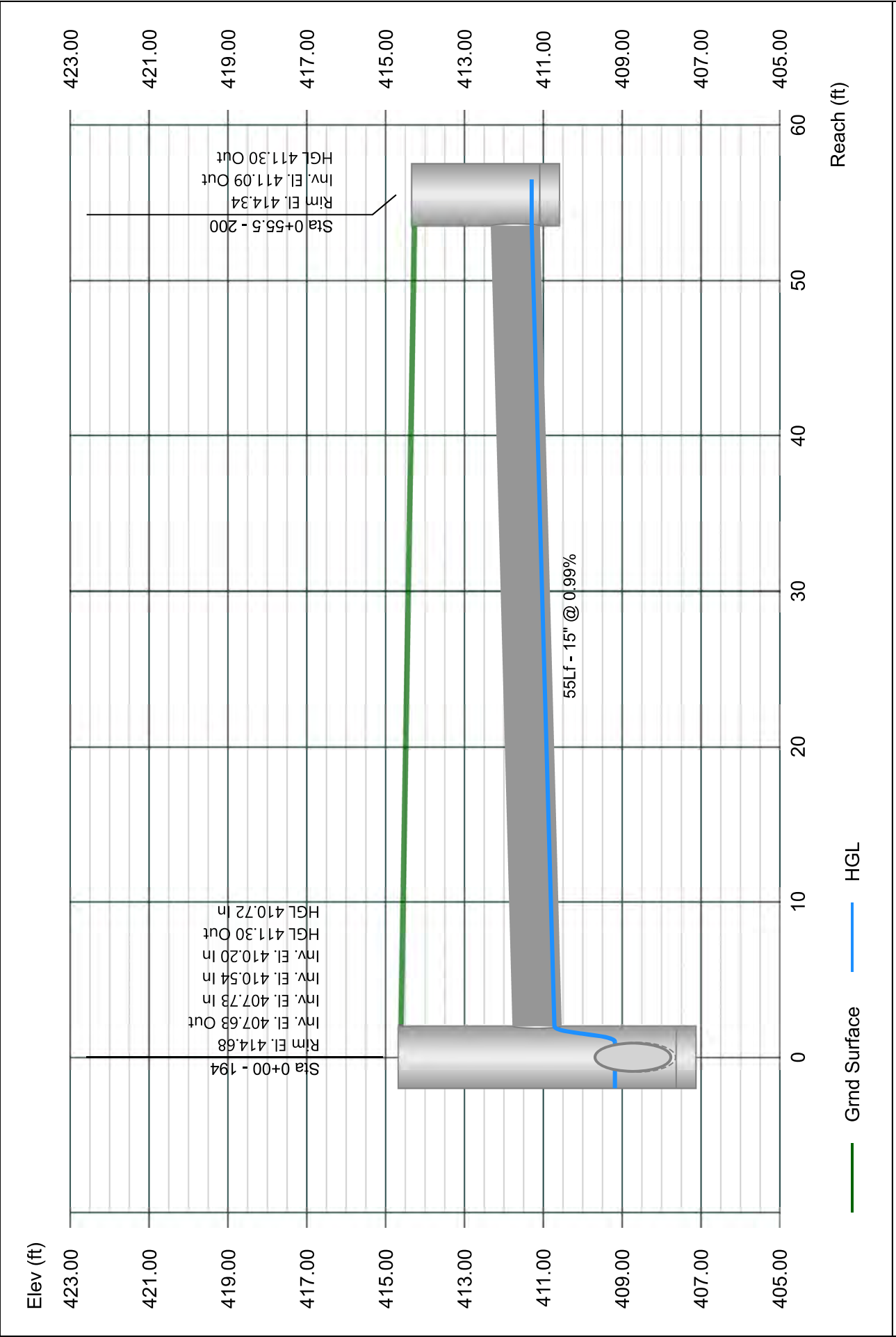

Line 101 - 201 TO 194

Stormwater Studio 2024 v 3.0.0.33

Project Name: Enter Project Name...

01-19-2024

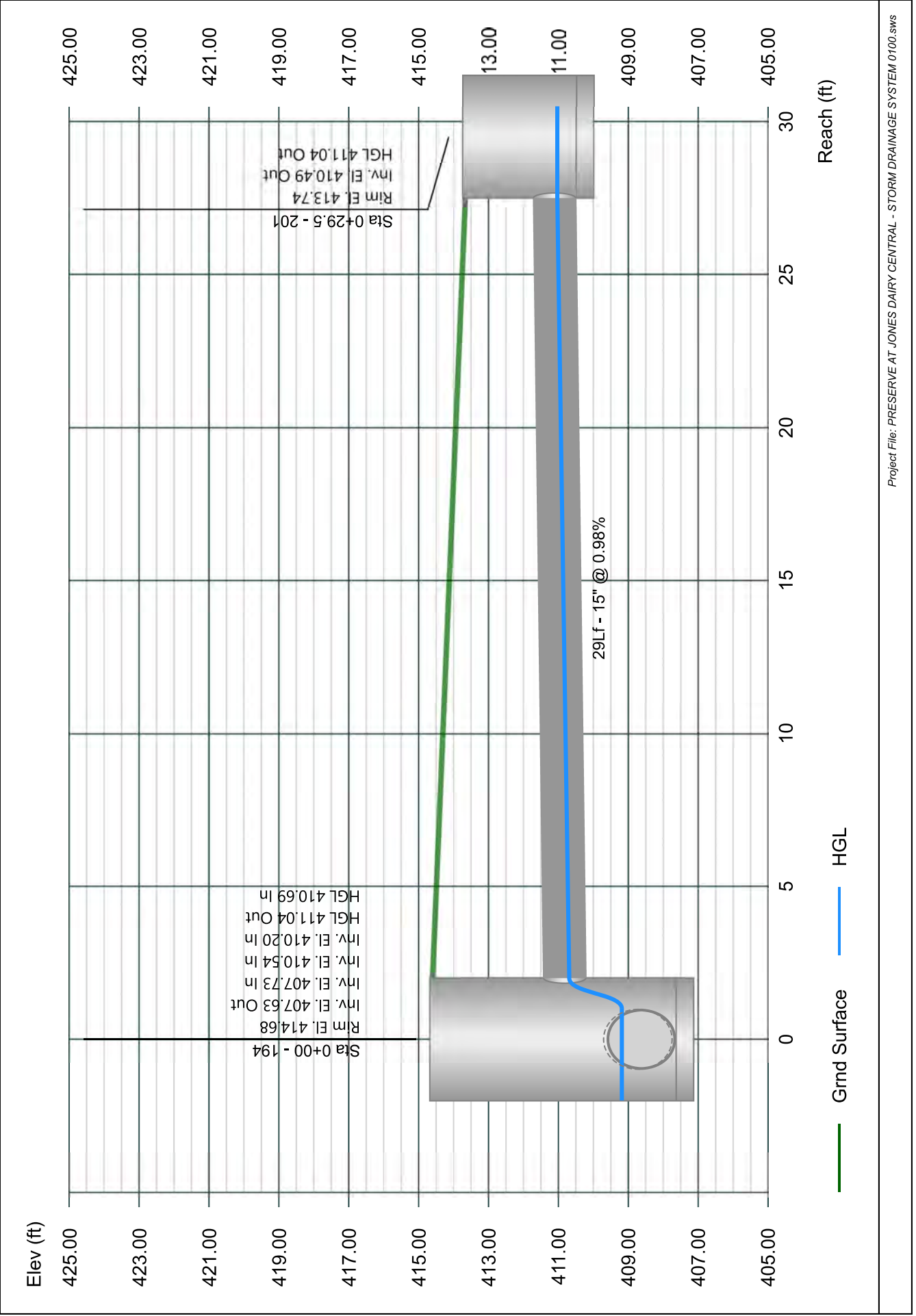

Line 102 - 202 TO 193

Stormwater Studio 2024 v 3.0.0.33

Project Name: Enter Project Name...

01-19-2024

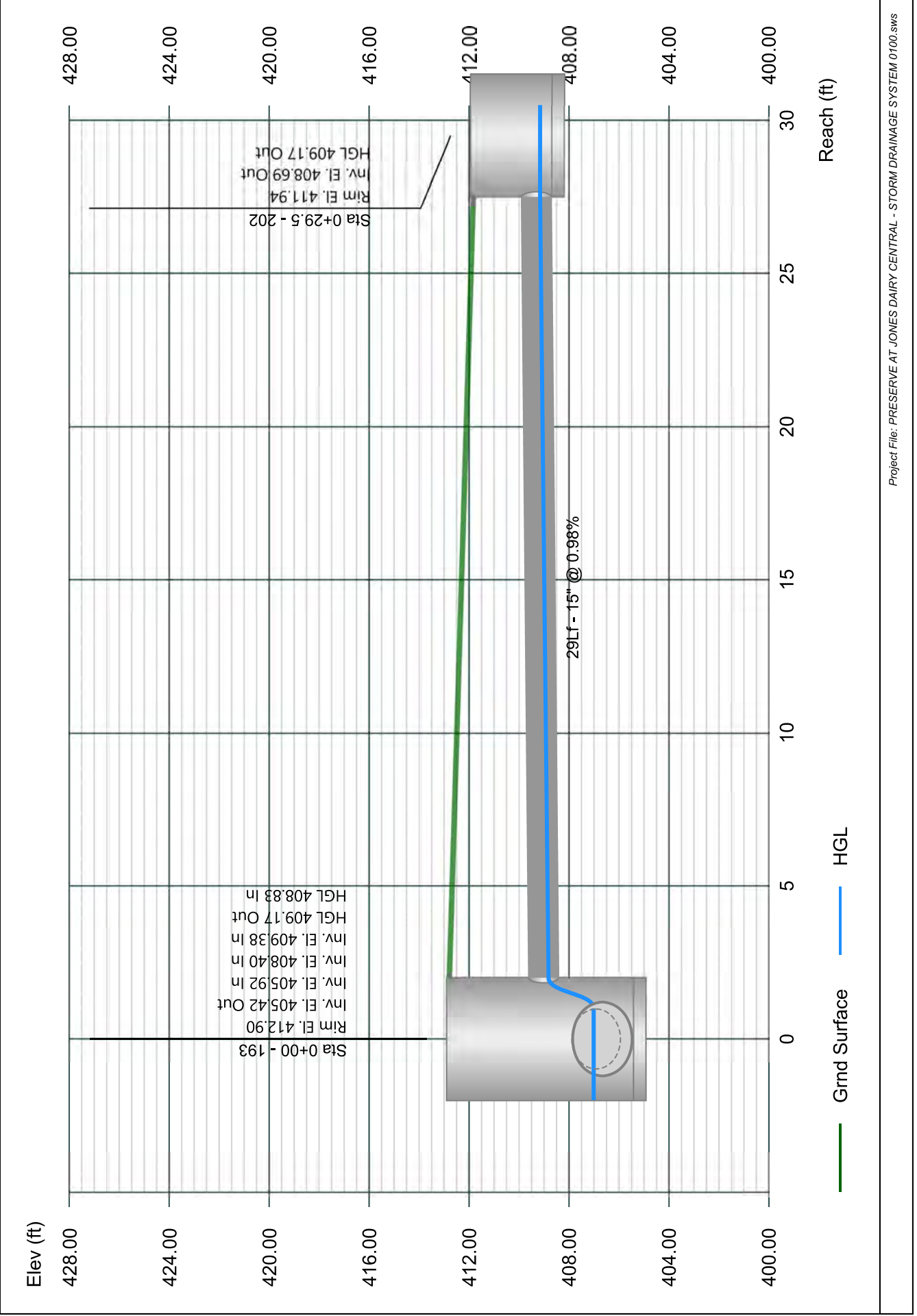

Line 103 - 203 TO 193

Stormwater Studio 2024 v 3.0.0.33

Project Name: Enter Project Name...

01-19-2024

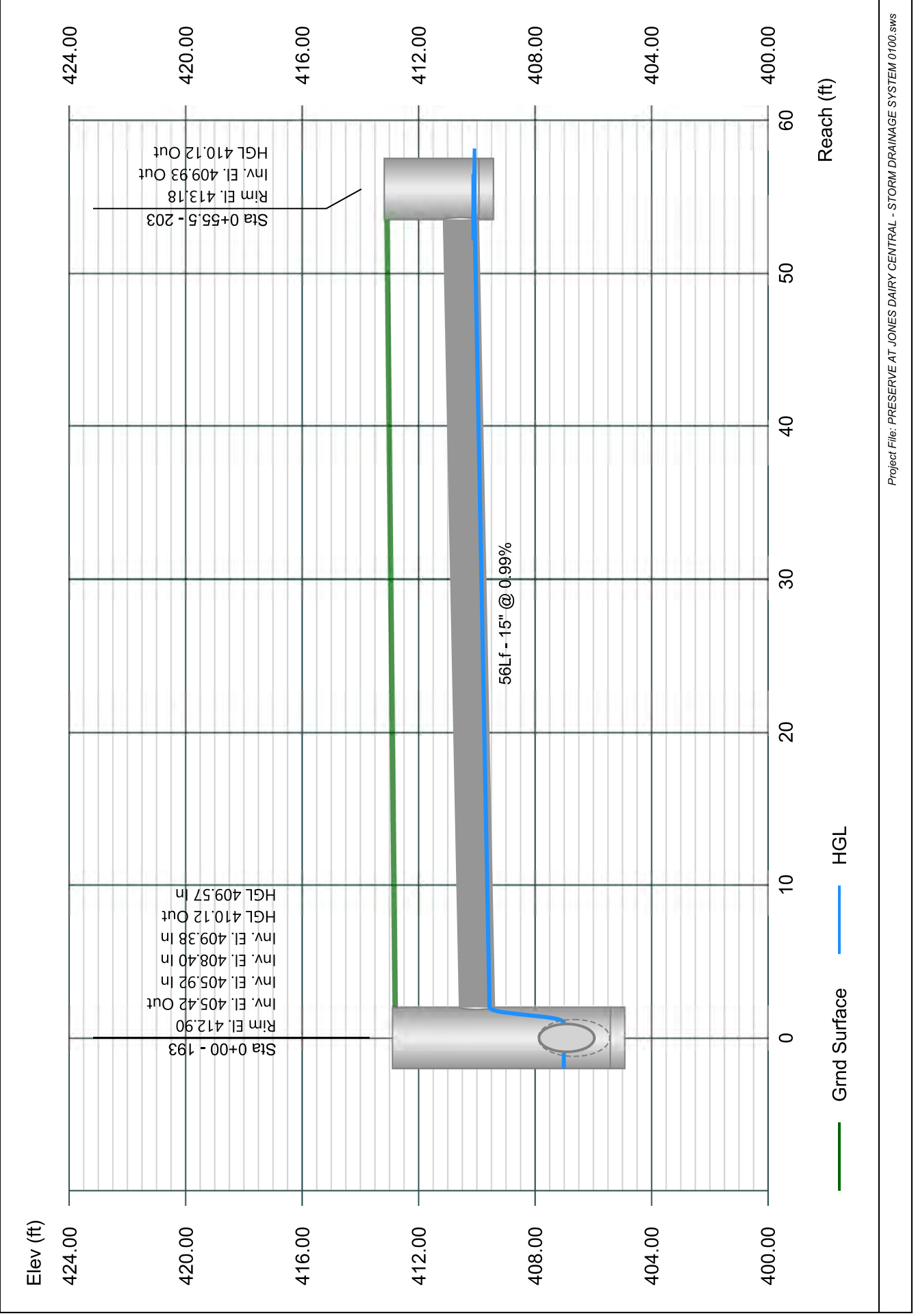

Line 104 - 204 TO 192

Stormwater Studio 2024 v 3.0.0.33

Project Name: Enter Project Name...

01-19-2024

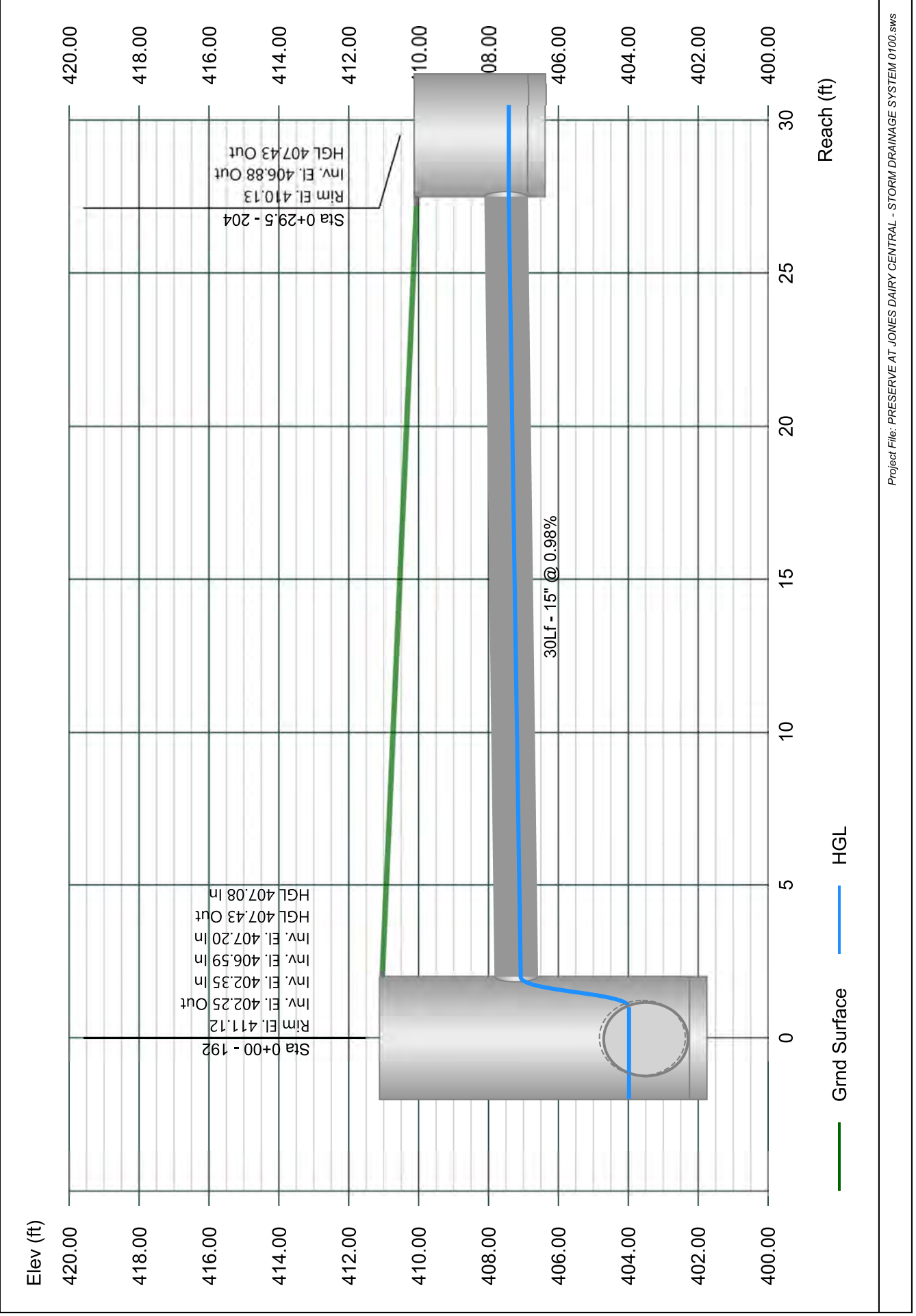

Line 105 - 205 TO 192

Stormwater Studio 2024 v 3.0.0.33

Project Name: Enter Project Name...

01-19-2024

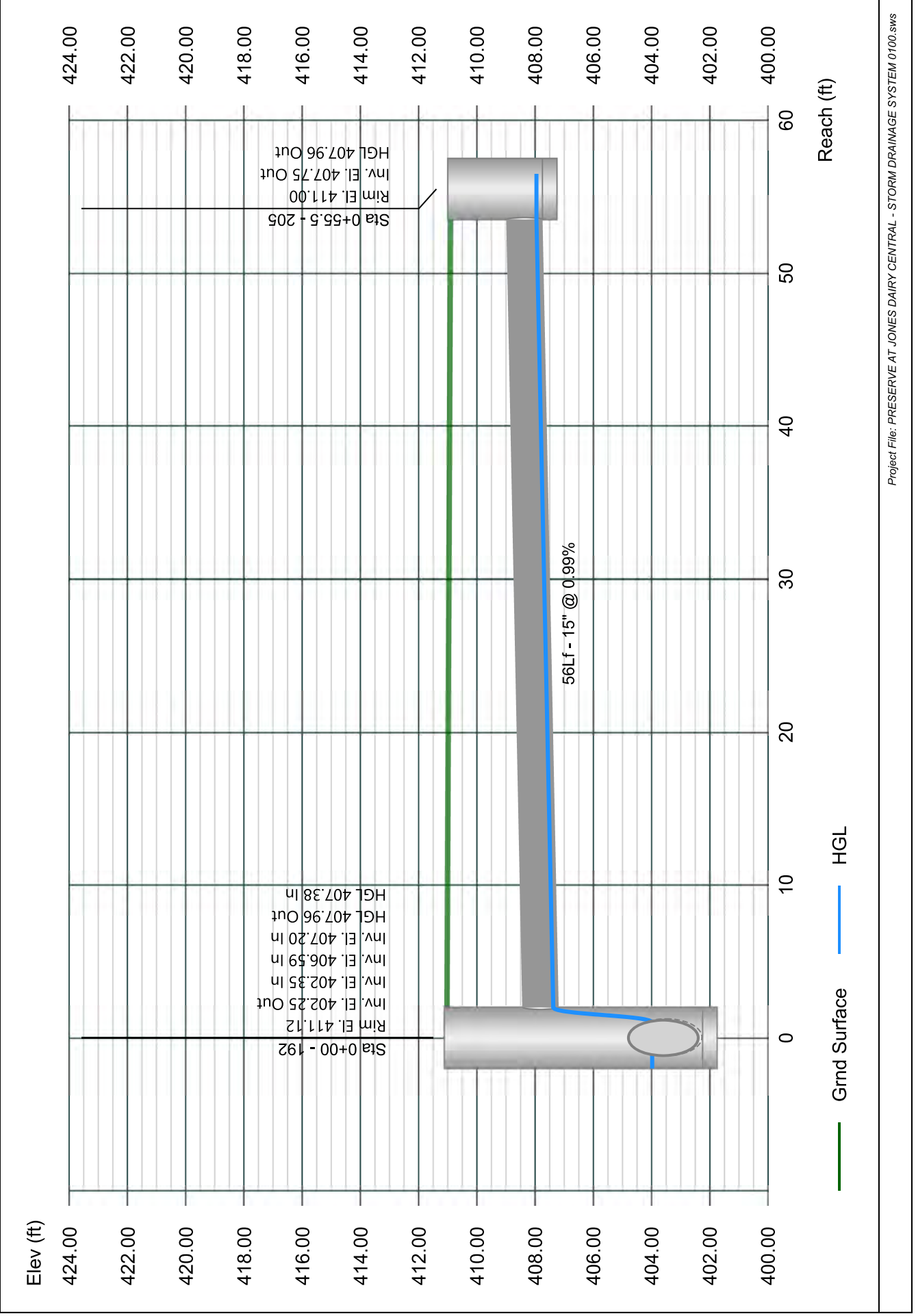

Line 106 - 206 TO 191

Stormwater Studio 2024 v 3.0.0.33

Project Name: Enter Project Name...

01-19-2024

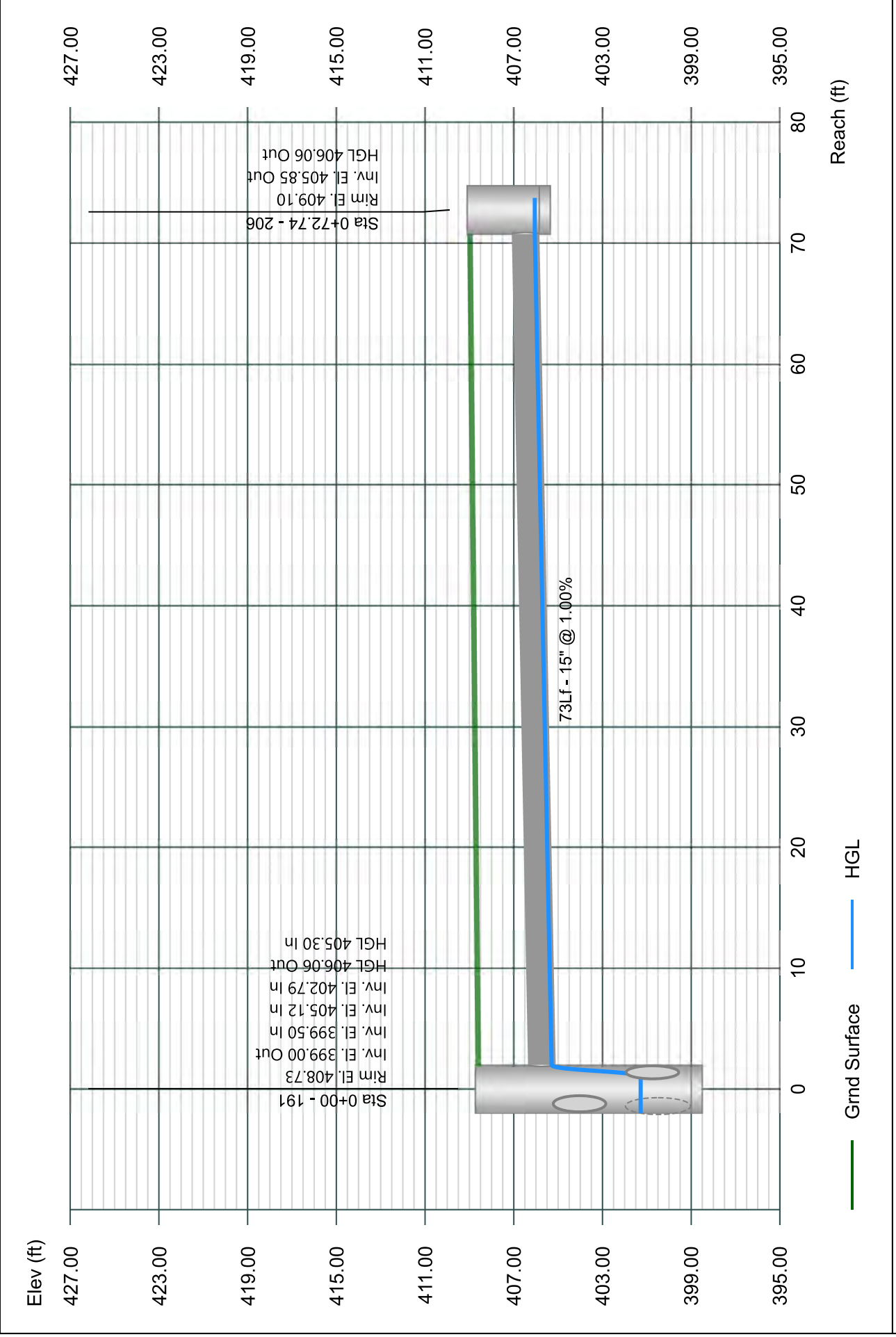

Line 107 - 207 TO 191

Stormwater Studio 2024 v 3.0.0.33

Project Name: Enter Project Name...

01-19-2024

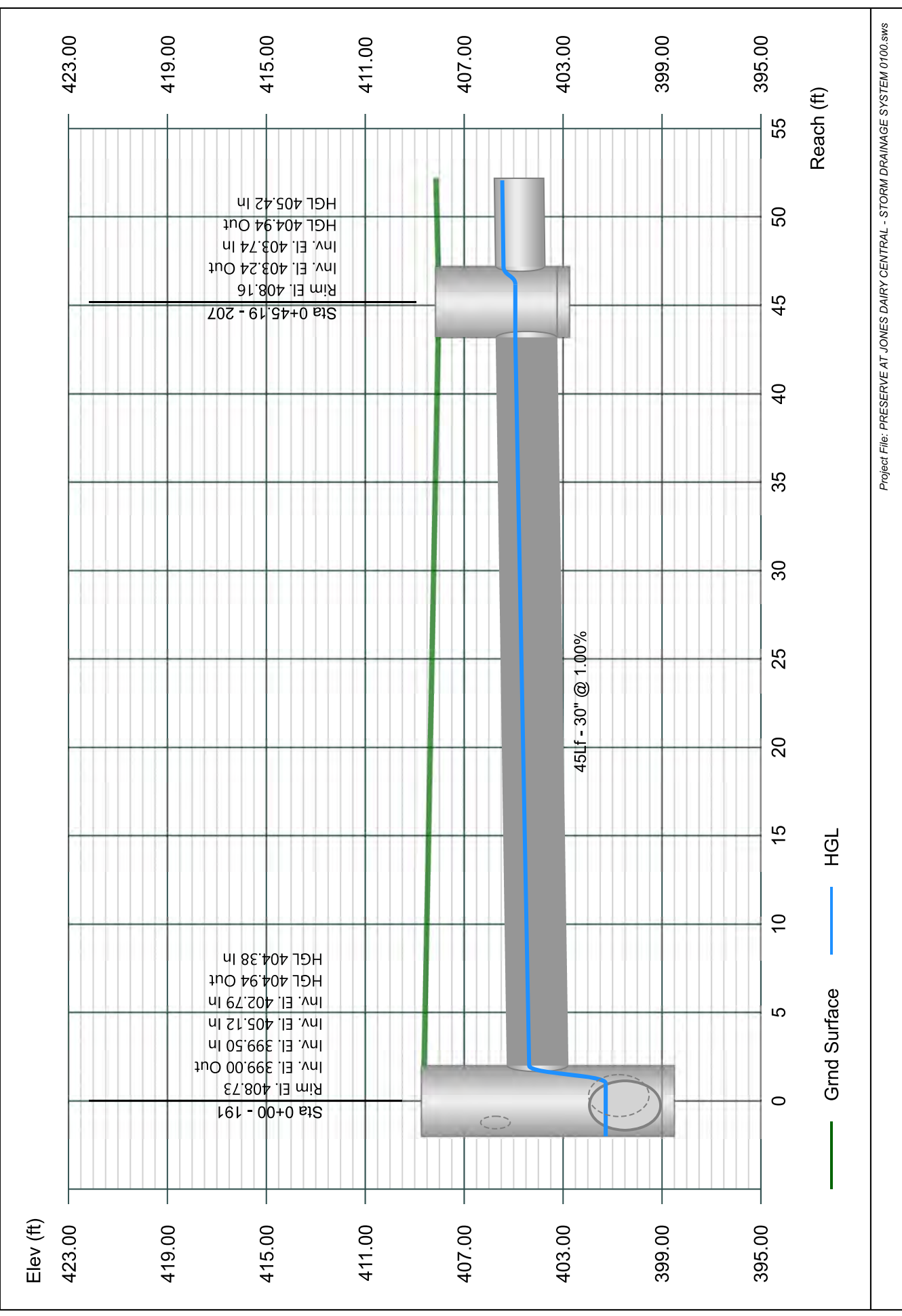

Line 108 - 208 TO 207

Stormwater Studio 2024 v 3.0.0.33

Project Name: Enter Project Name...

01-19-2024

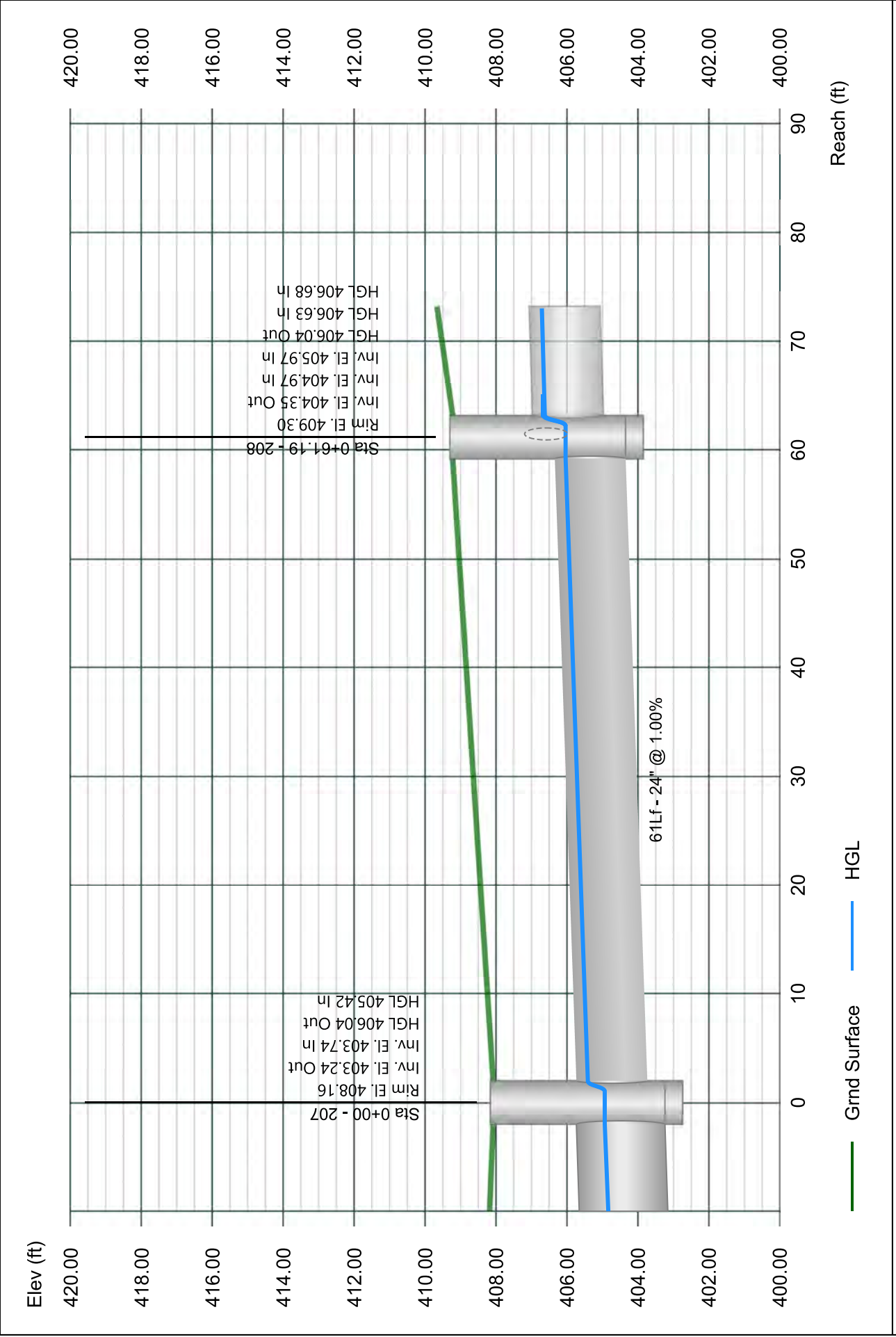

Line 109 - 209 TO 208

Stormwater Studio 2024 v 3.0.0.33

Project Name: Enter Project Name...

01-19-2024

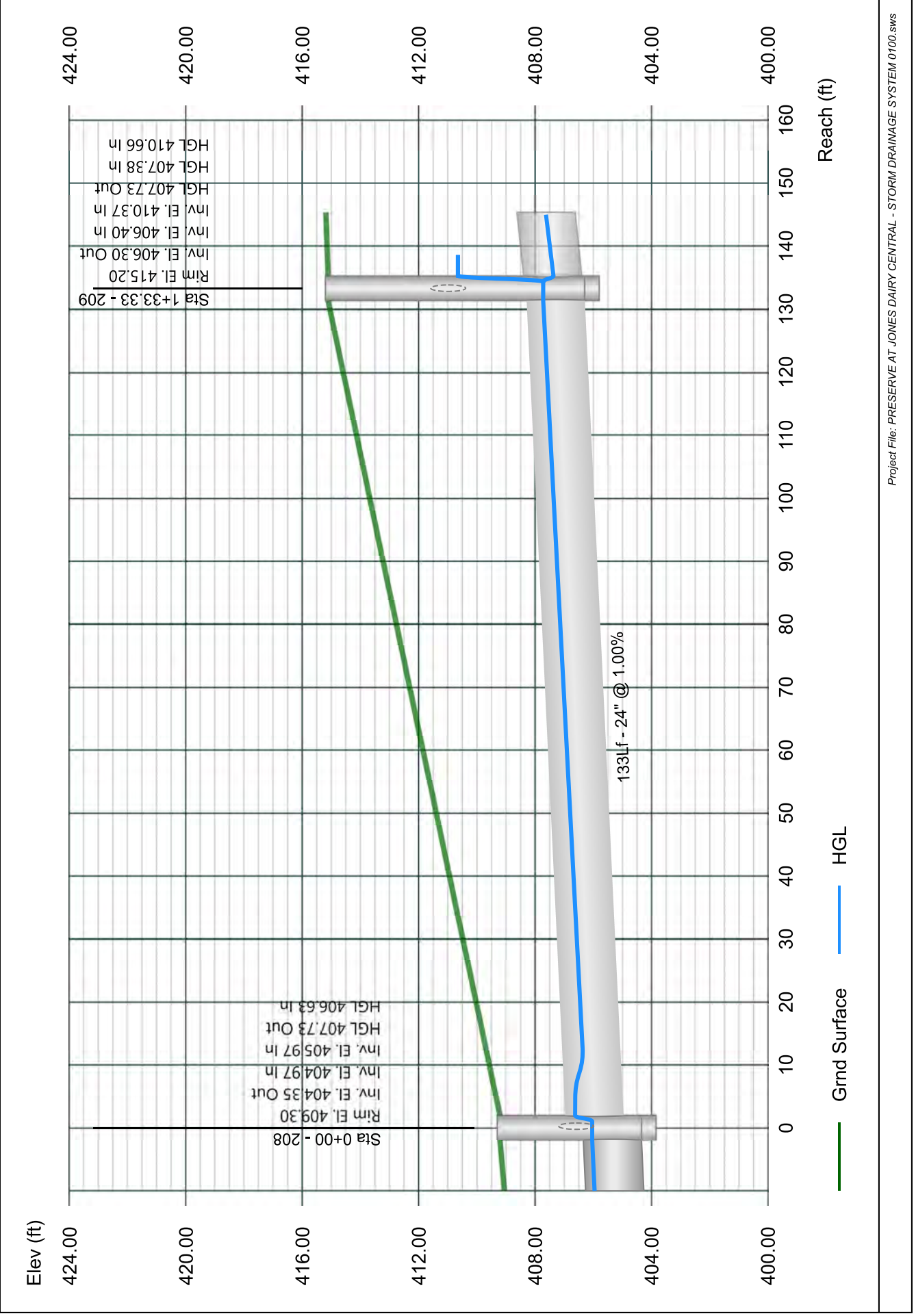

Line 110 - 210 TO 209

Stormwater Studio 2024 v 3.0.0.33

Project Name: Enter Project Name...

01-19-2024

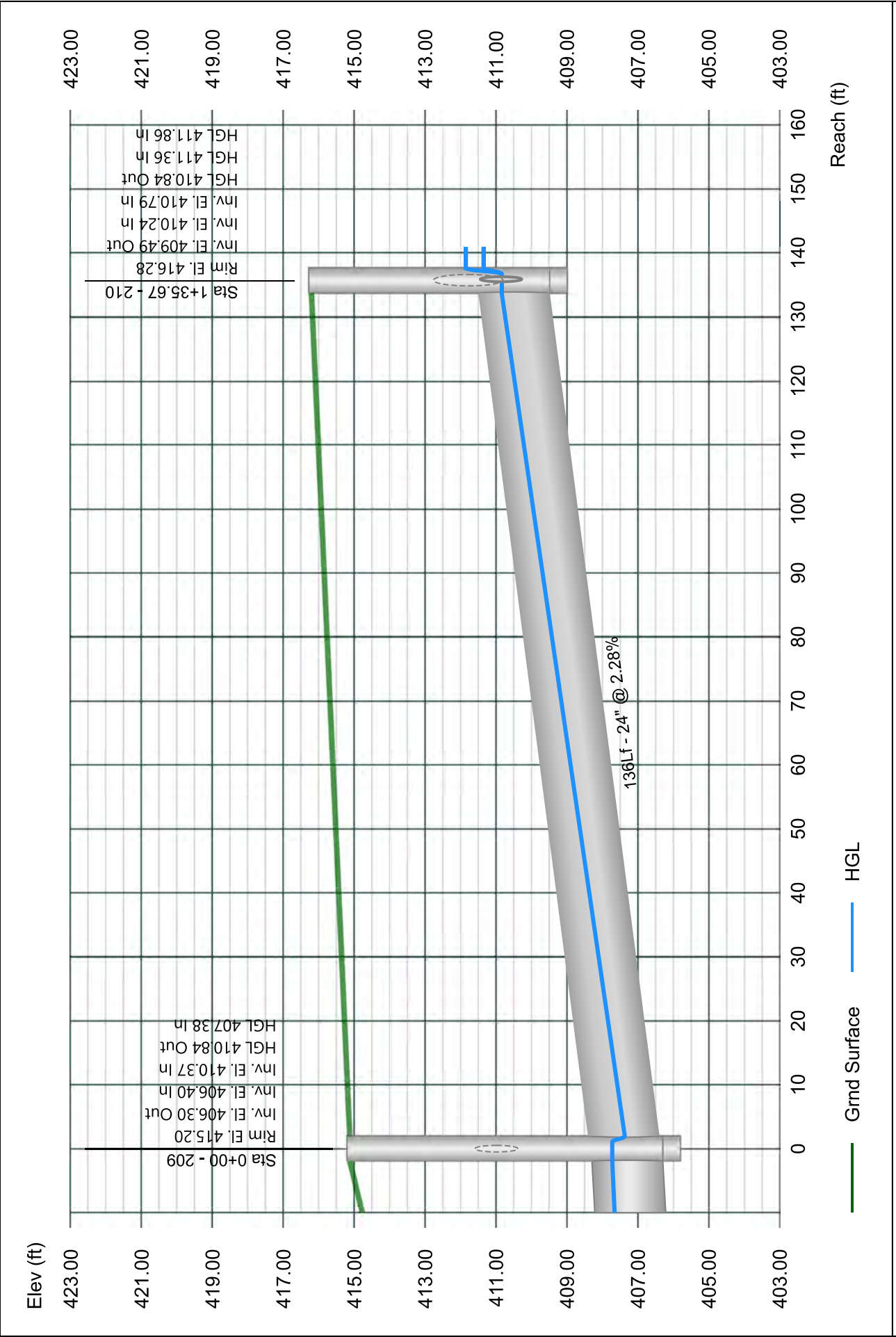

Line 111 - 211 TO 210

Stormwater Studio 2024 v 3.0.0.33

Project Name: Enter Project Name...

01-19-2024

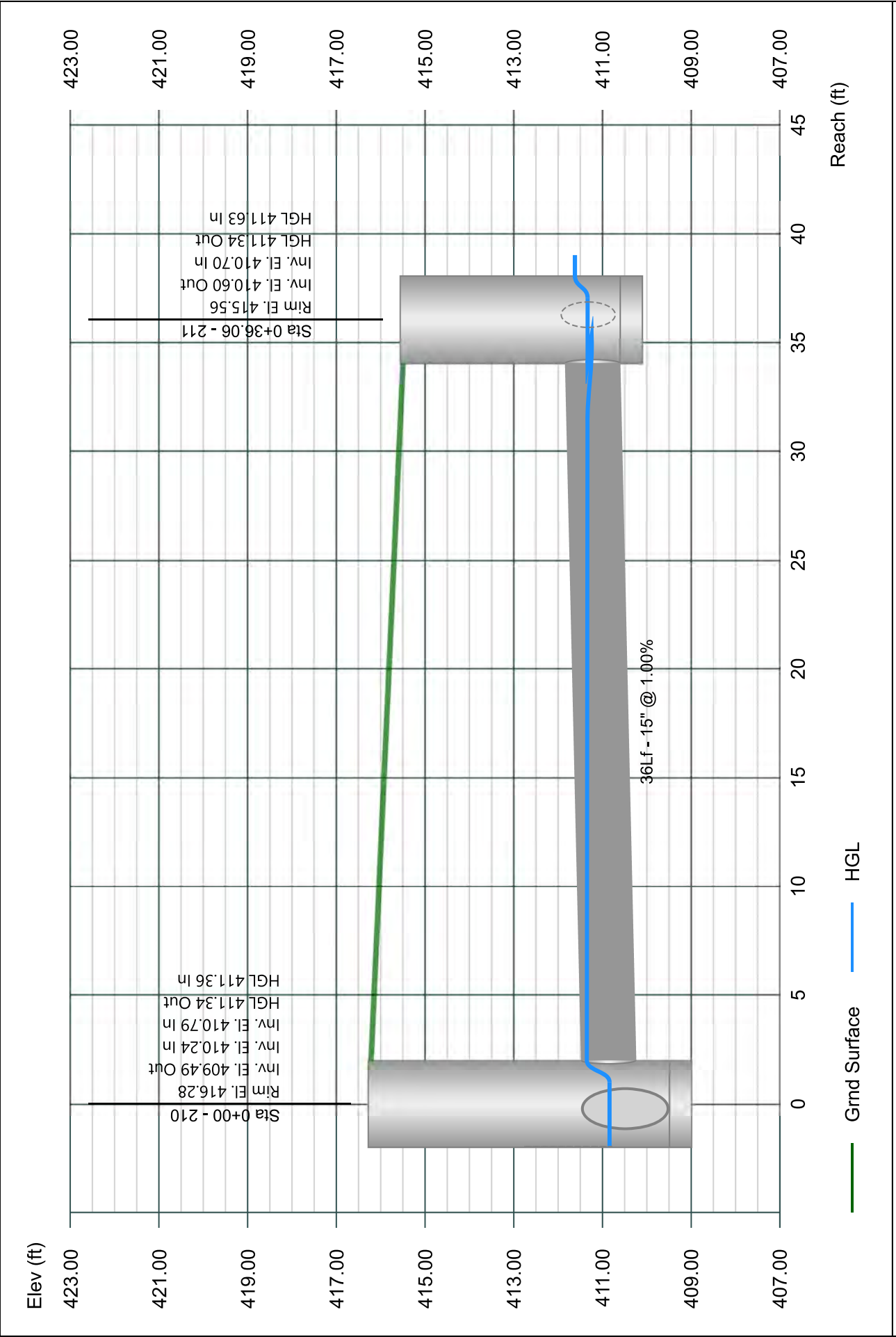

Line 112 - 212 TO 211

Stormwater Studio 2024 v 3.0.0.33

Project Name: Enter Project Name...

01-19-2024

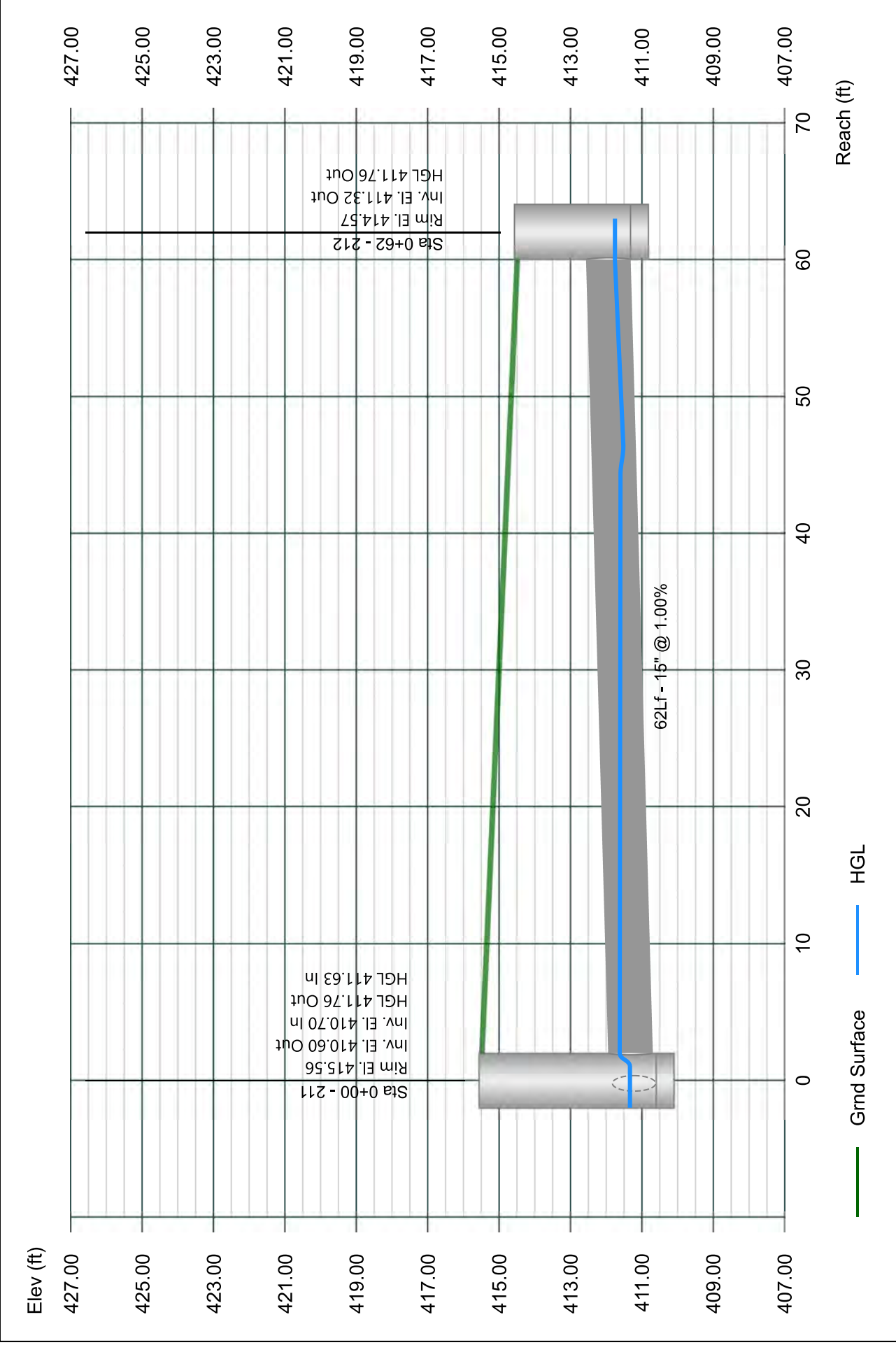

Line 113 - 213 TO 210

Stormwater Studio 2024 v 3.0.0.33

Project Name: Enter Project Name...

01-19-2024

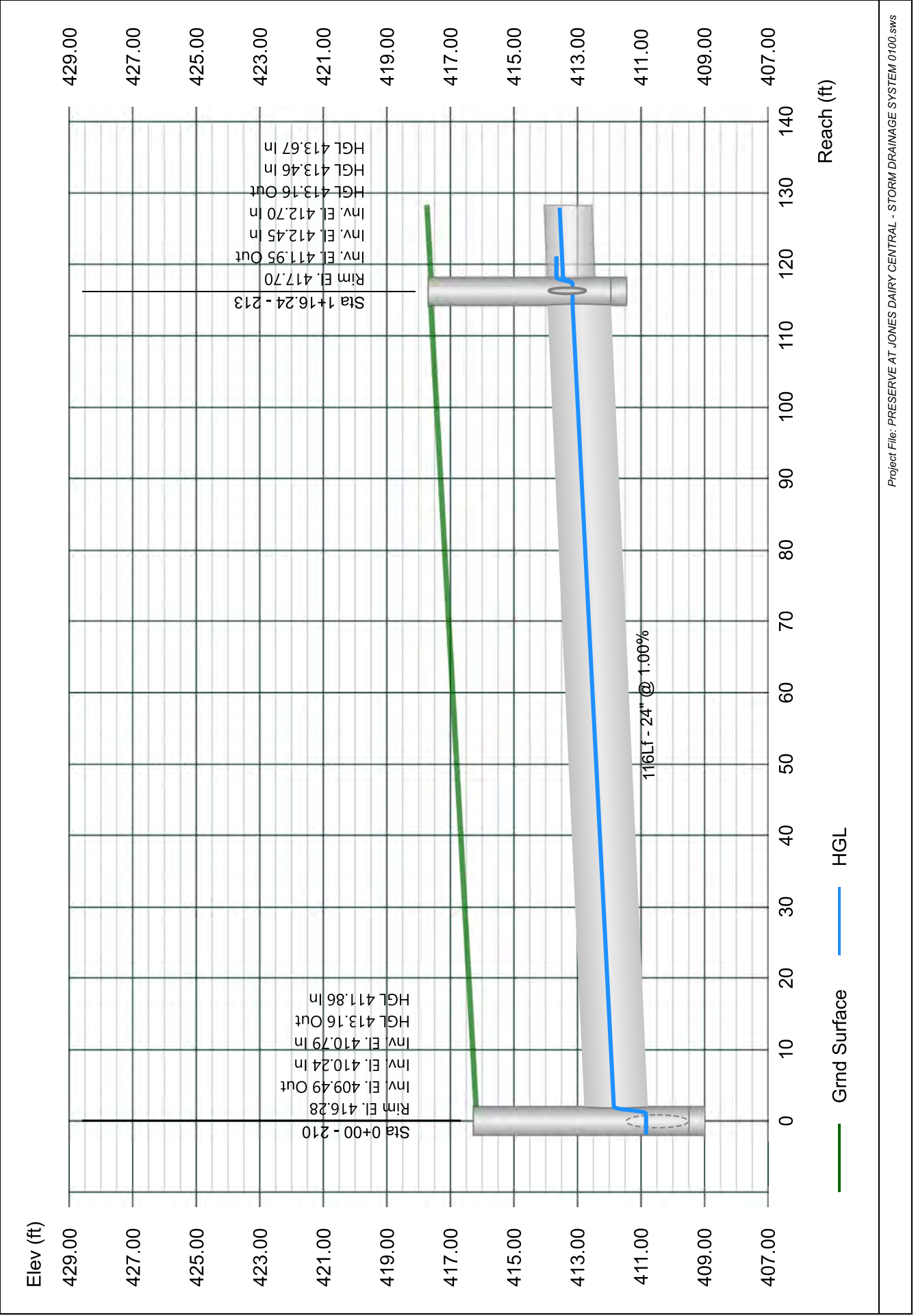

Line 114 - 213A TO 213

Stormwater Studio 2024 v 3.0.0.33

Project Name: Enter Project Name...

01-19-2024

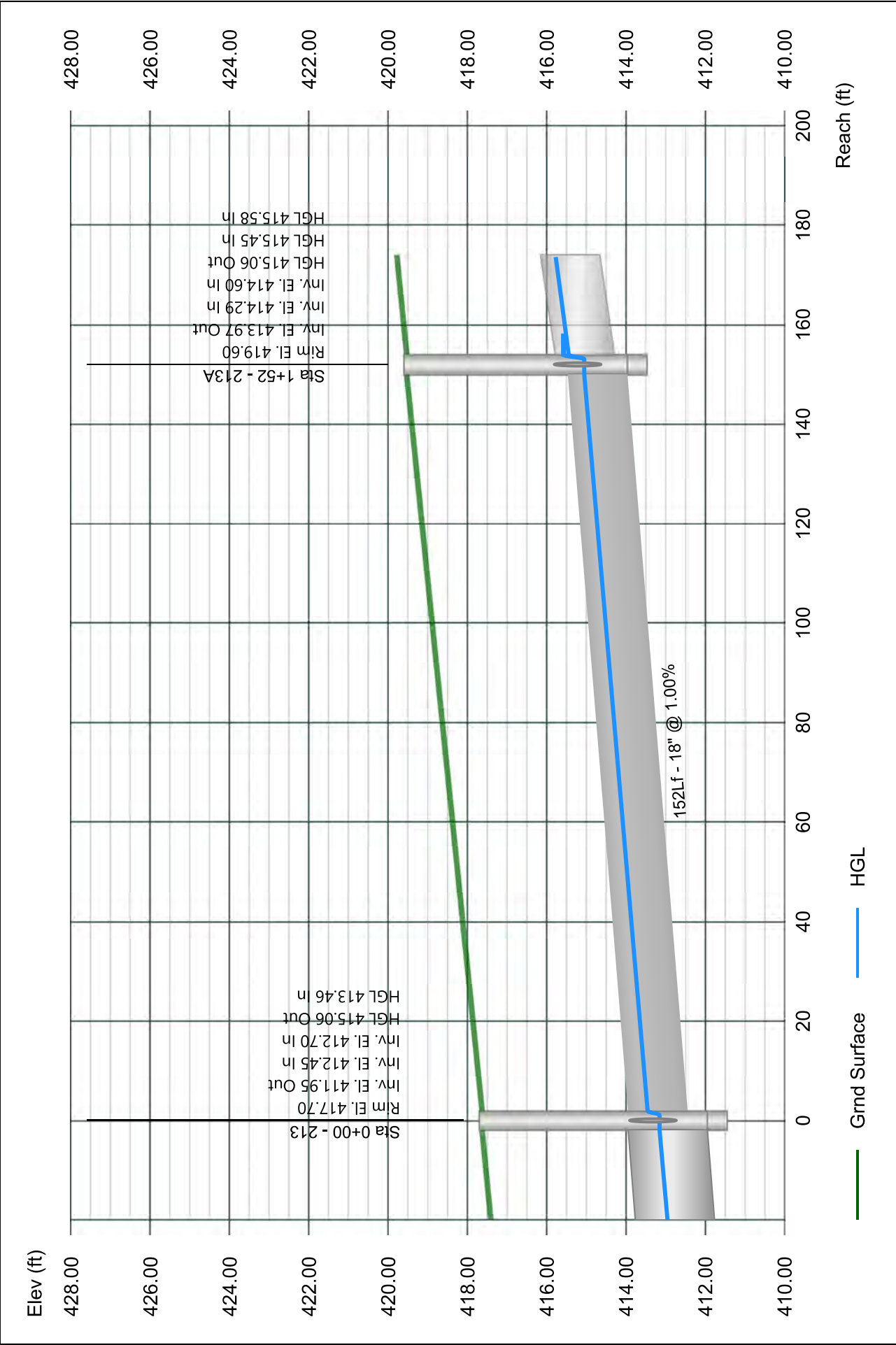

Line 115 - 214 TO 213A

Stormwater Studio 2024 v 3.0.0.33

Project Name: Enter Project Name...

01-19-2024

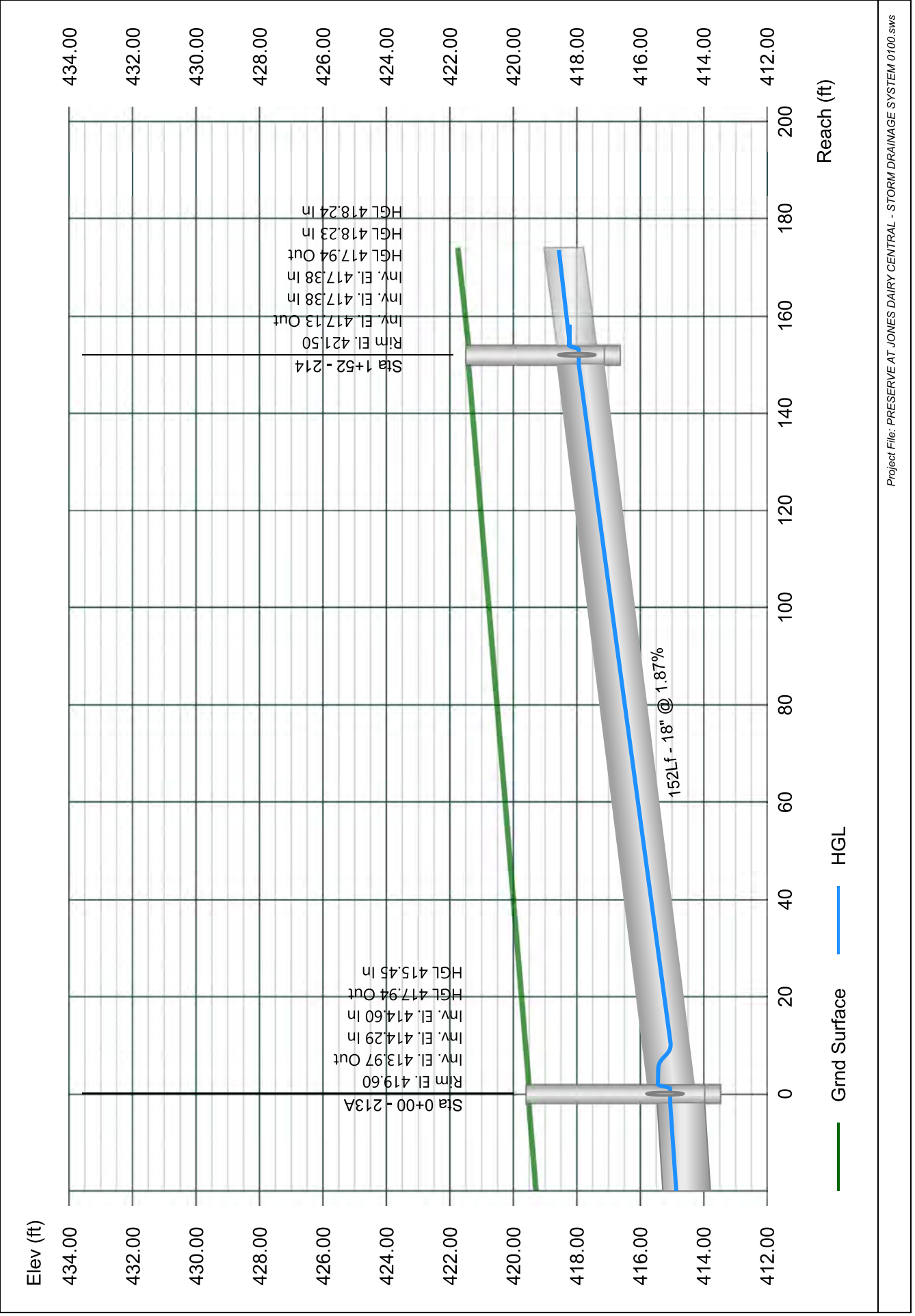

Line 116 - 215 TO 214

Stormwater Studio 2024 v 3.0.0.33

Project Name: Enter Project Name...

01-19-2024

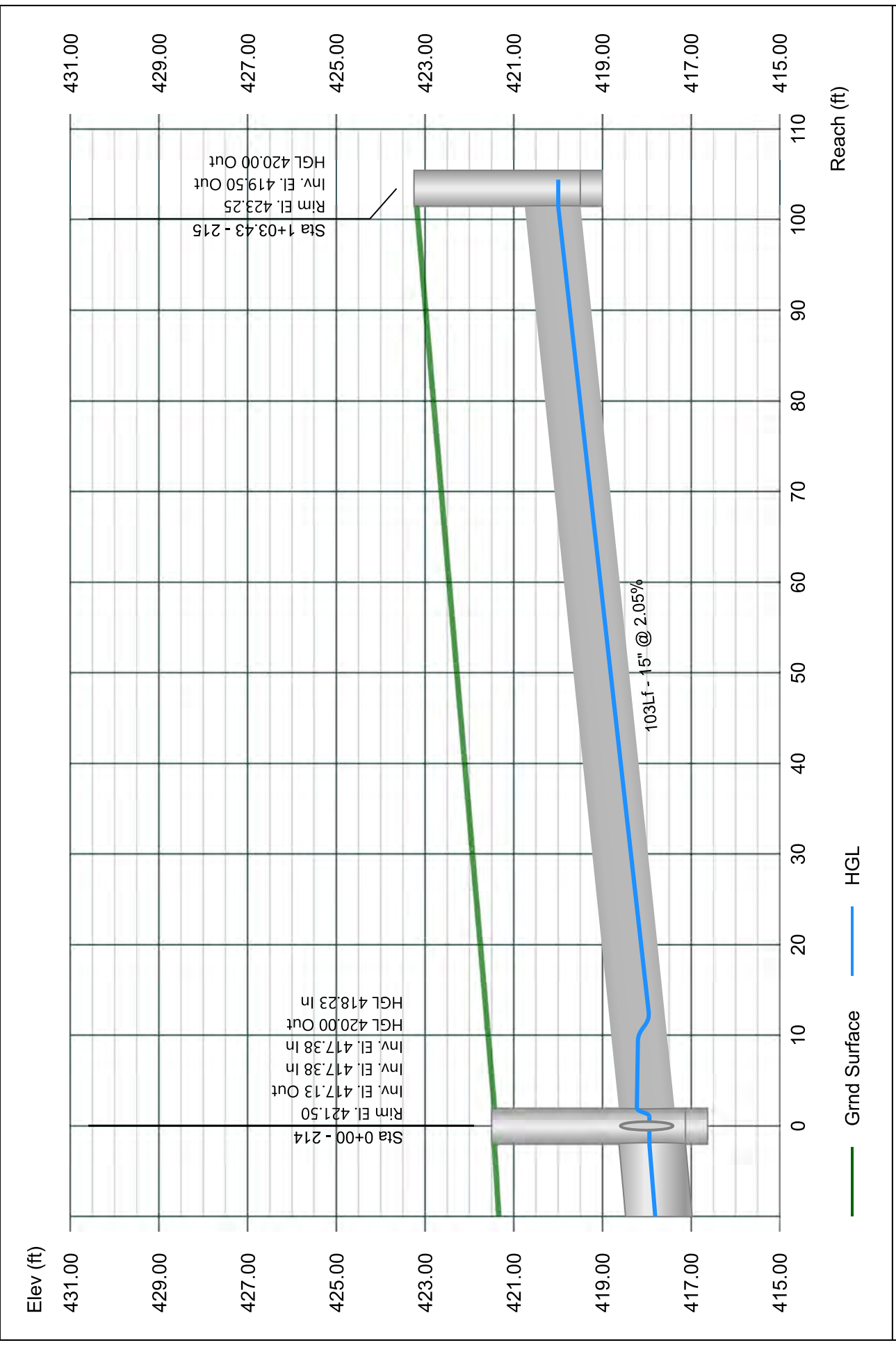

Line 117 - 216 TO 214

Stormwater Studio 2024 v 3.0.0.33

Project Name: Enter Project Name...

01-19-2024

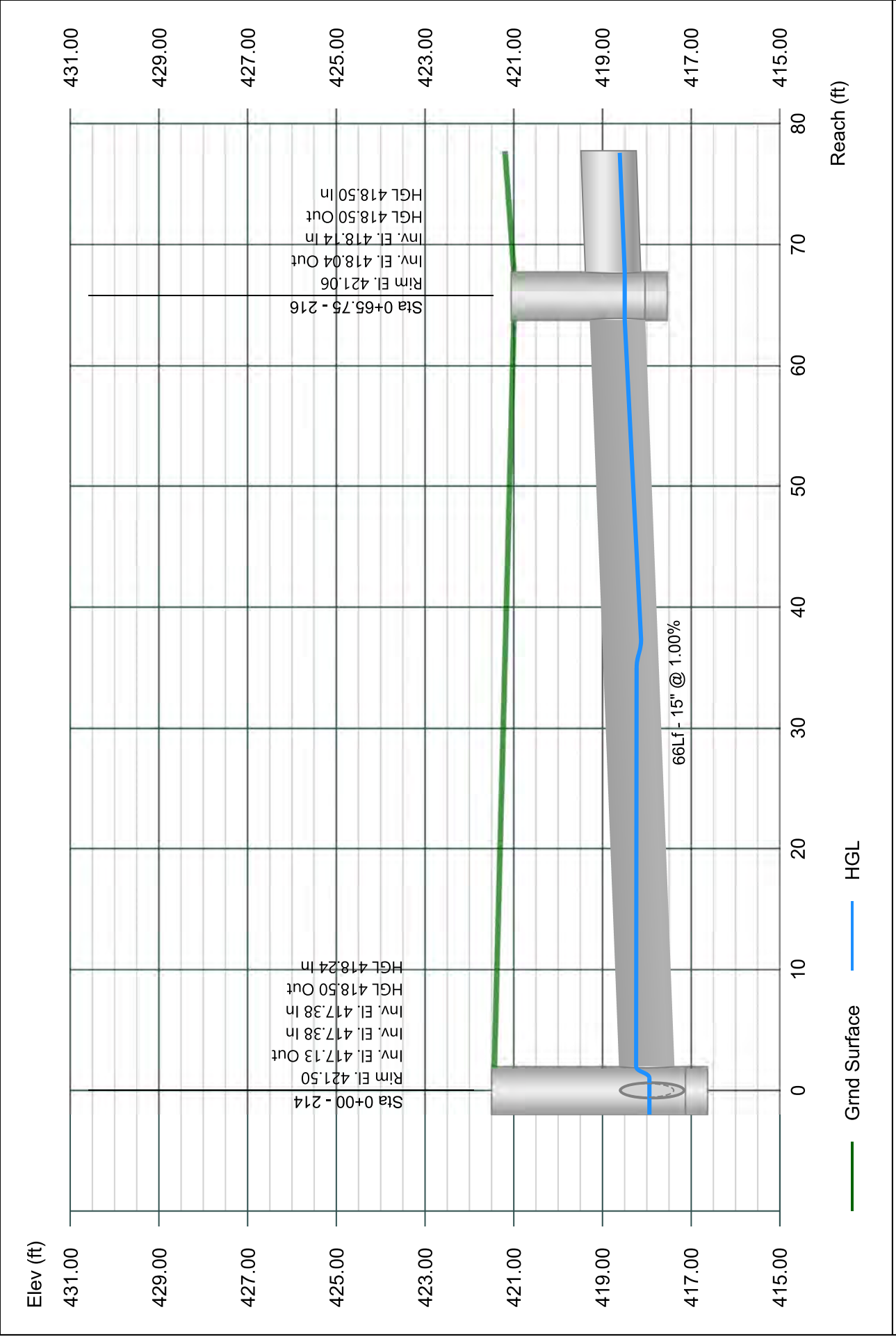

Line 118 - 217 TO 216

Stormwater Studio 2024 v 3.0.0.33

Project Name: Enter Project Name...

01-19-2024

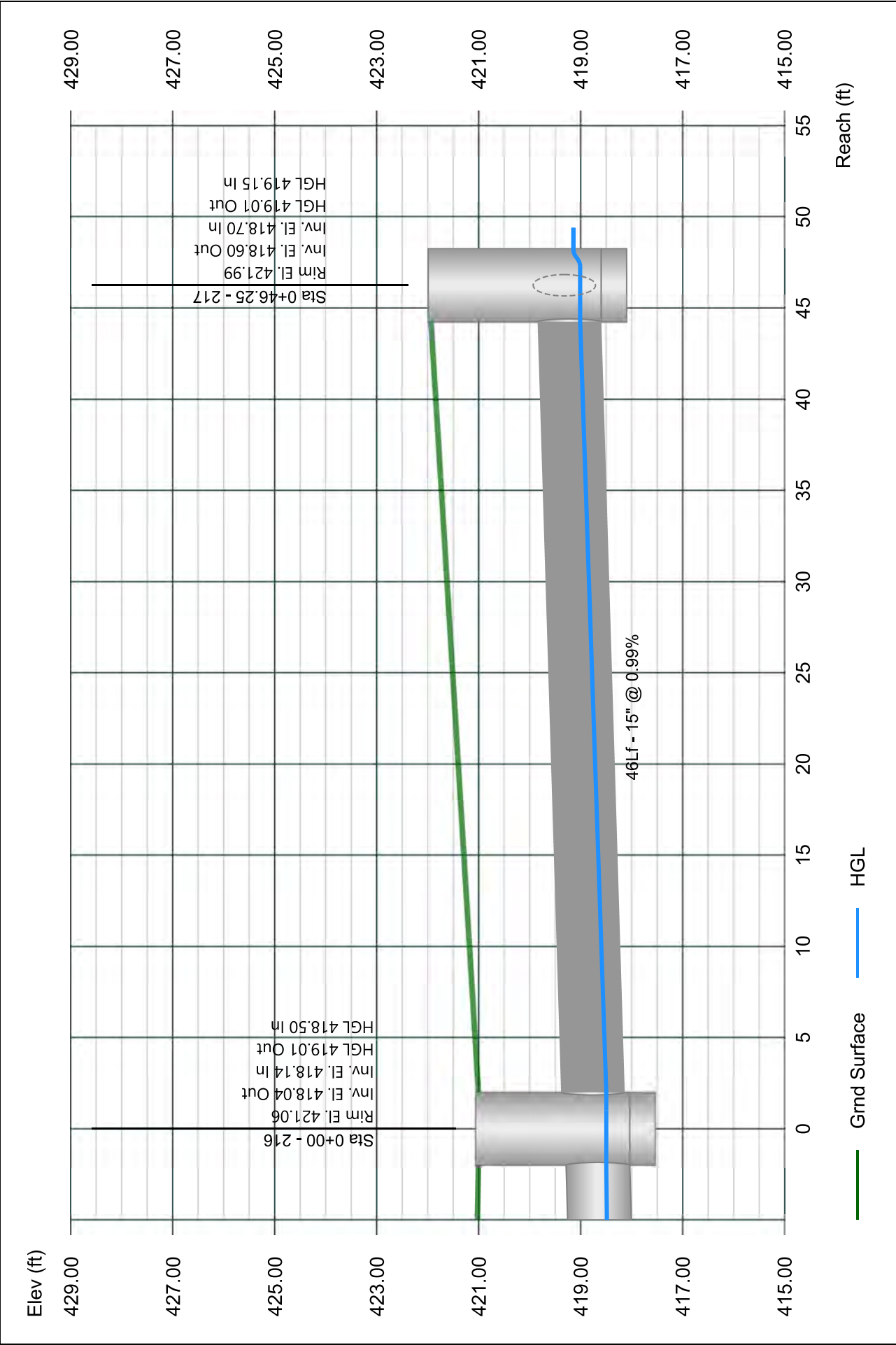

Line 119 - 218 TO 217

Stormwater Studio 2024 v 3.0.0.33

Project Name: Enter Project Name...

01-19-2024

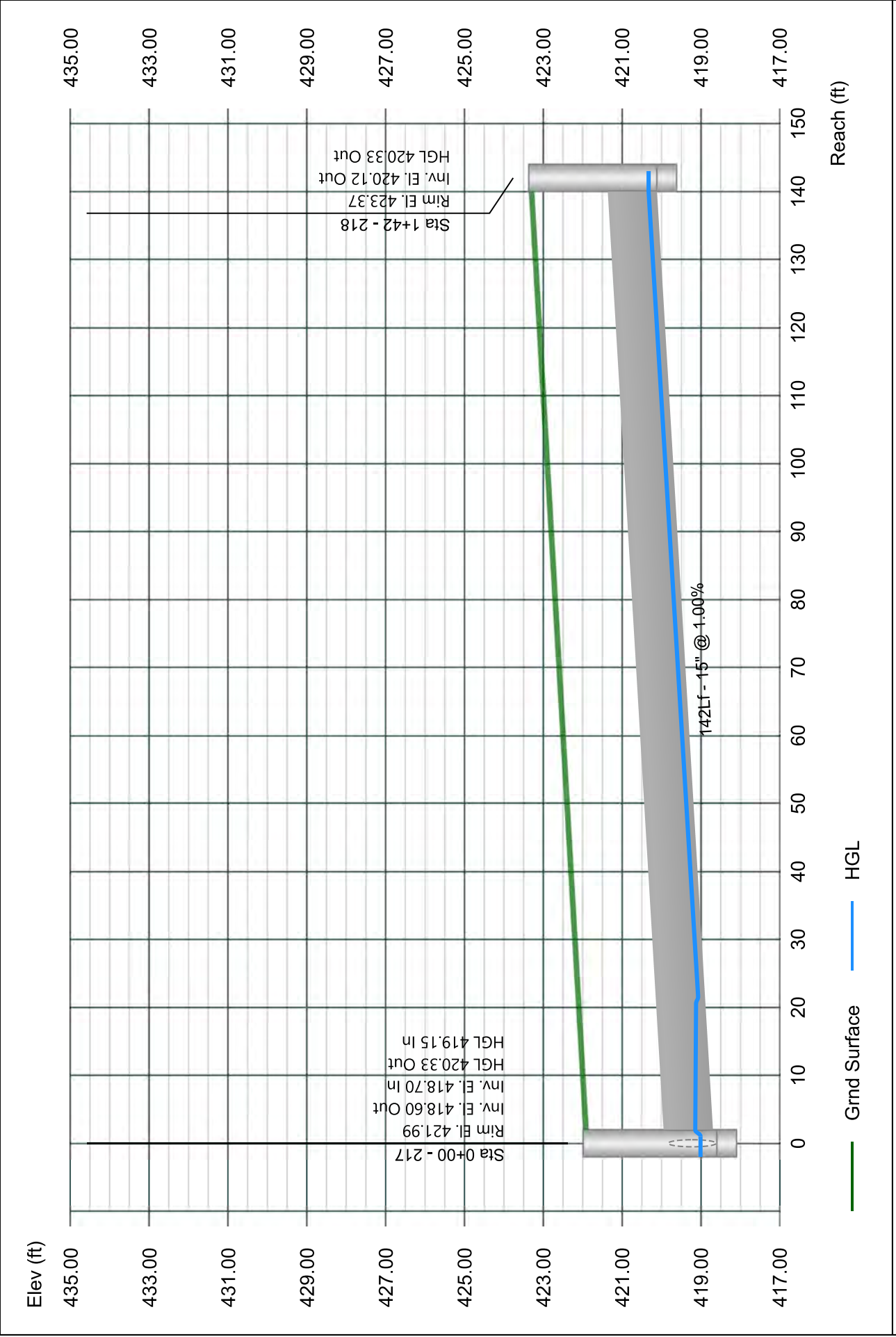

Line 120 - 219 TO 213

Stormwater Studio 2024 v 3.0.0.33

Project Name: Enter Project Name...

01-19-2024

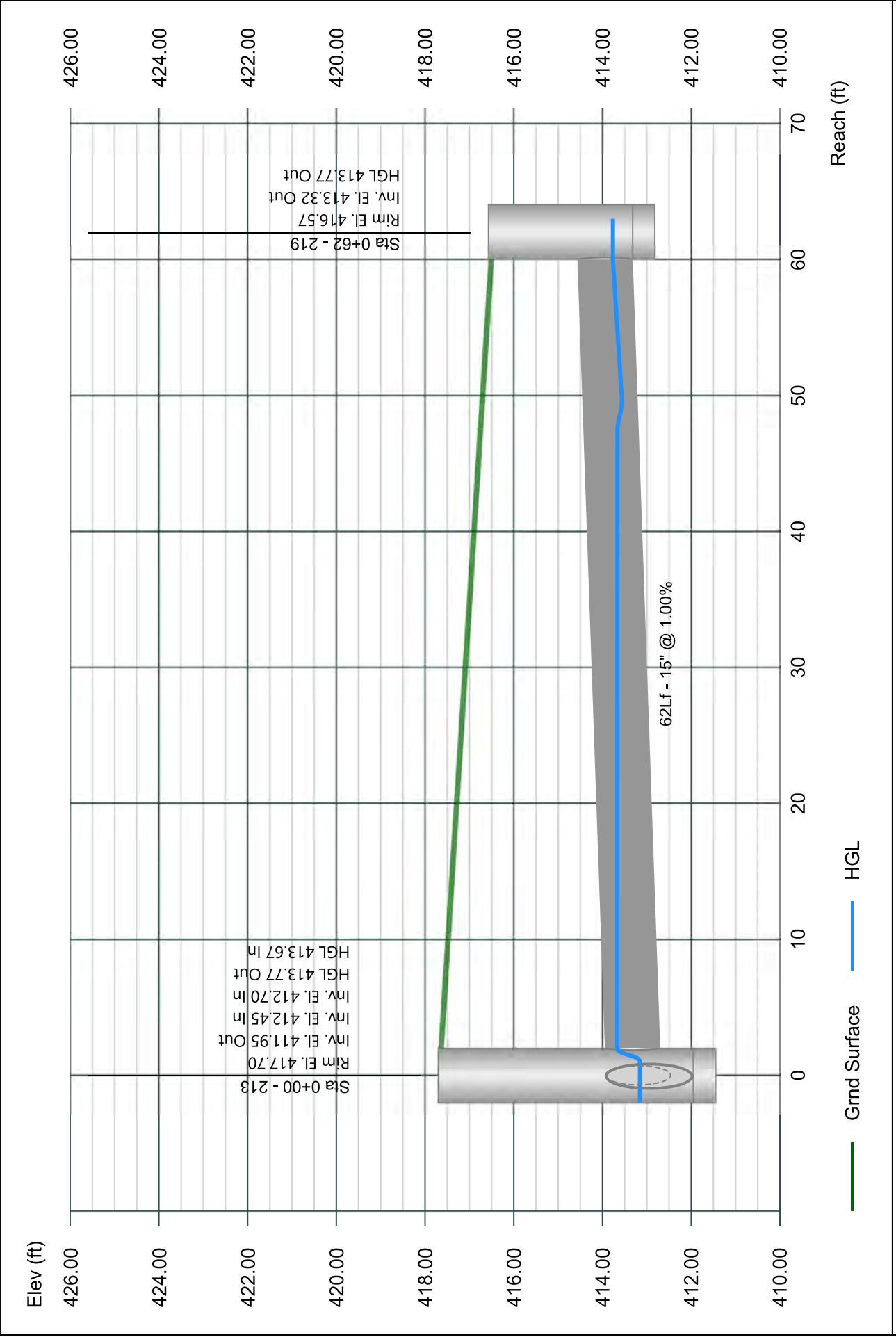

Line 121 - 220 TO 209

Stormwater Studio 2024 v 3.0.0.33

Project Name: Enter Project Name...

01-19-2024

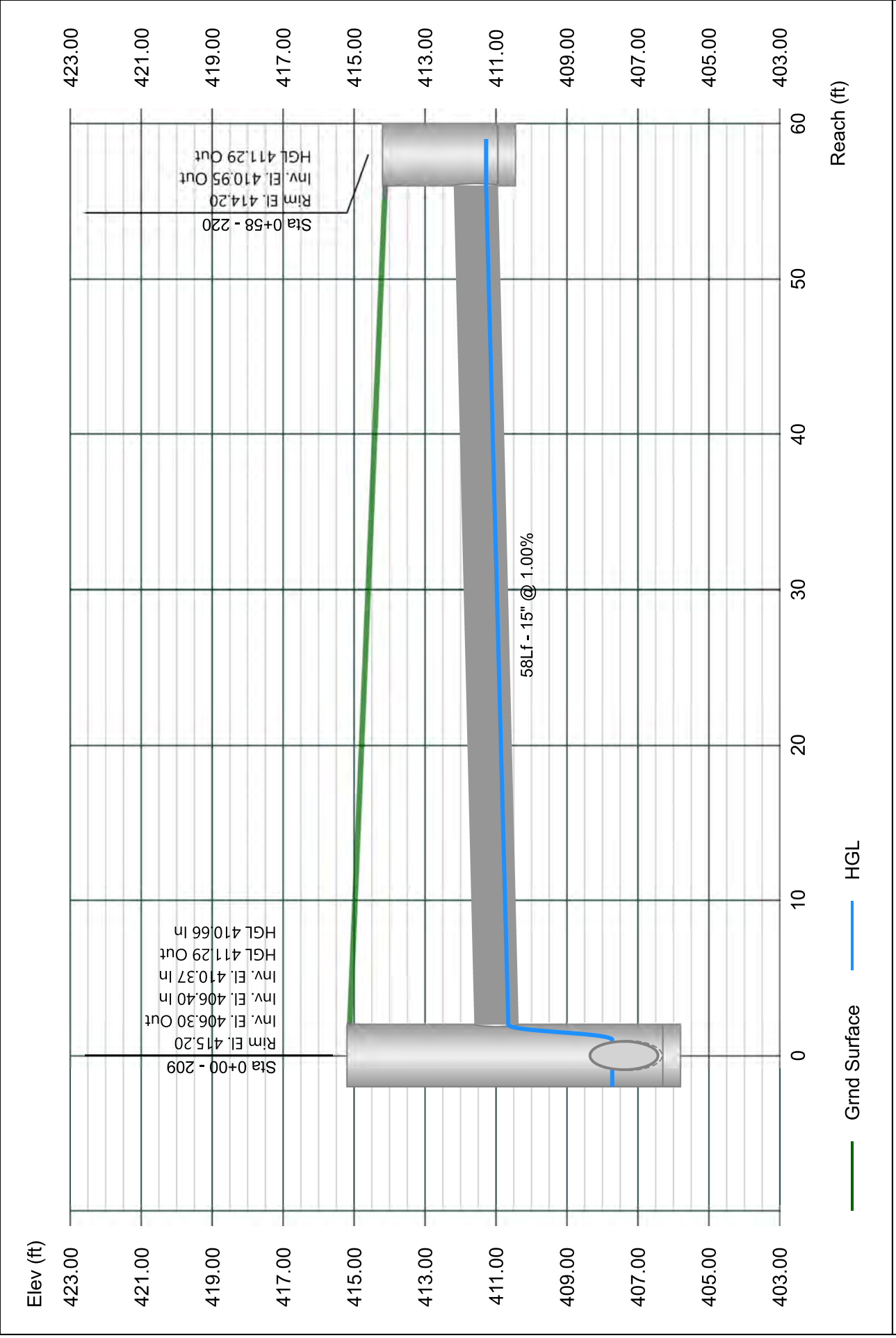

Line 122 - 221 TO 208

Stormwater Studio 2024 v 3.0.0.33

Project Name: Enter Project Name...

01-19-2024

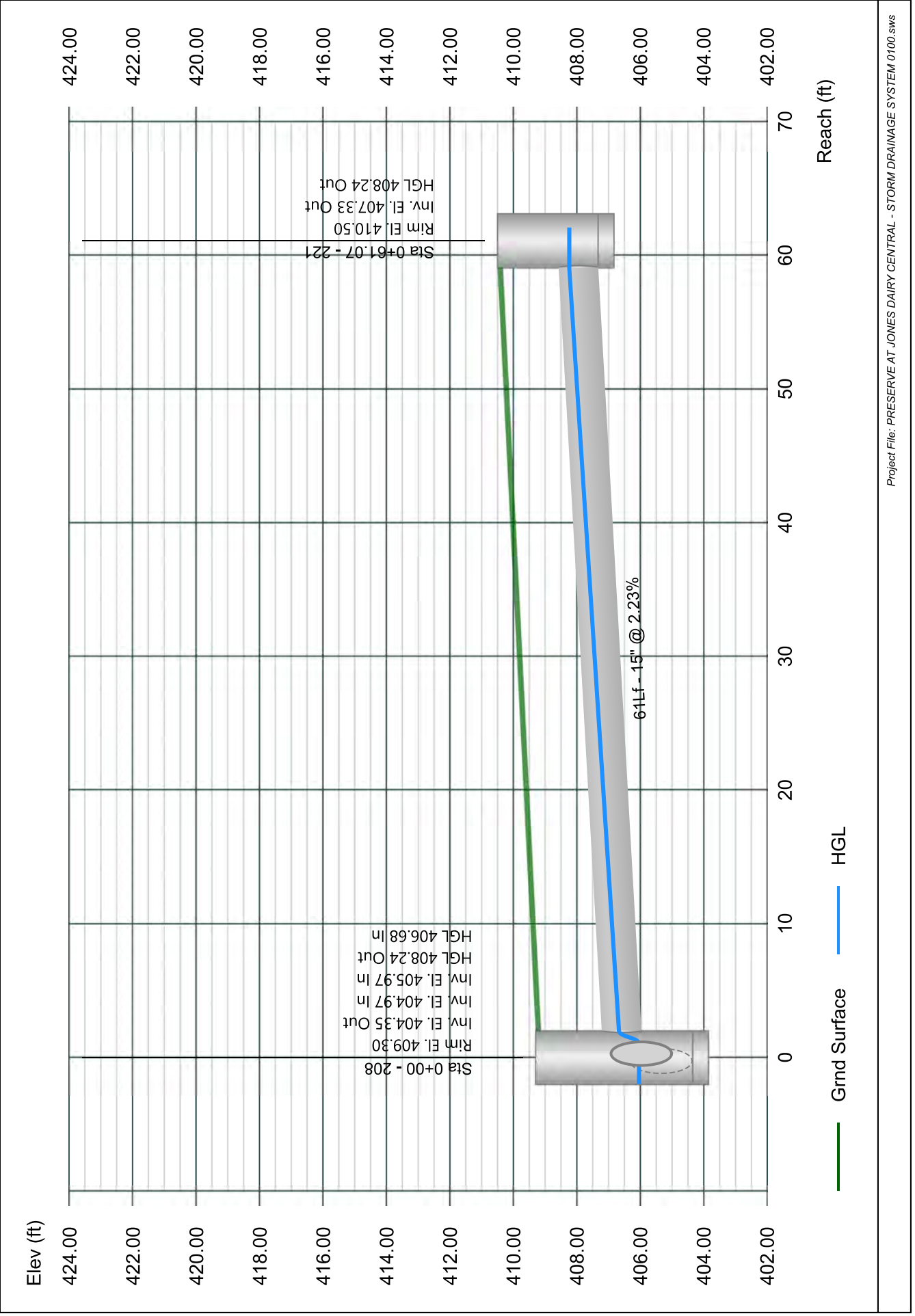

Line 123 - 222 TO 190

Stormwater Studio 2024 v 3.0.0.33

Project Name: Enter Project Name...

01-19-2024

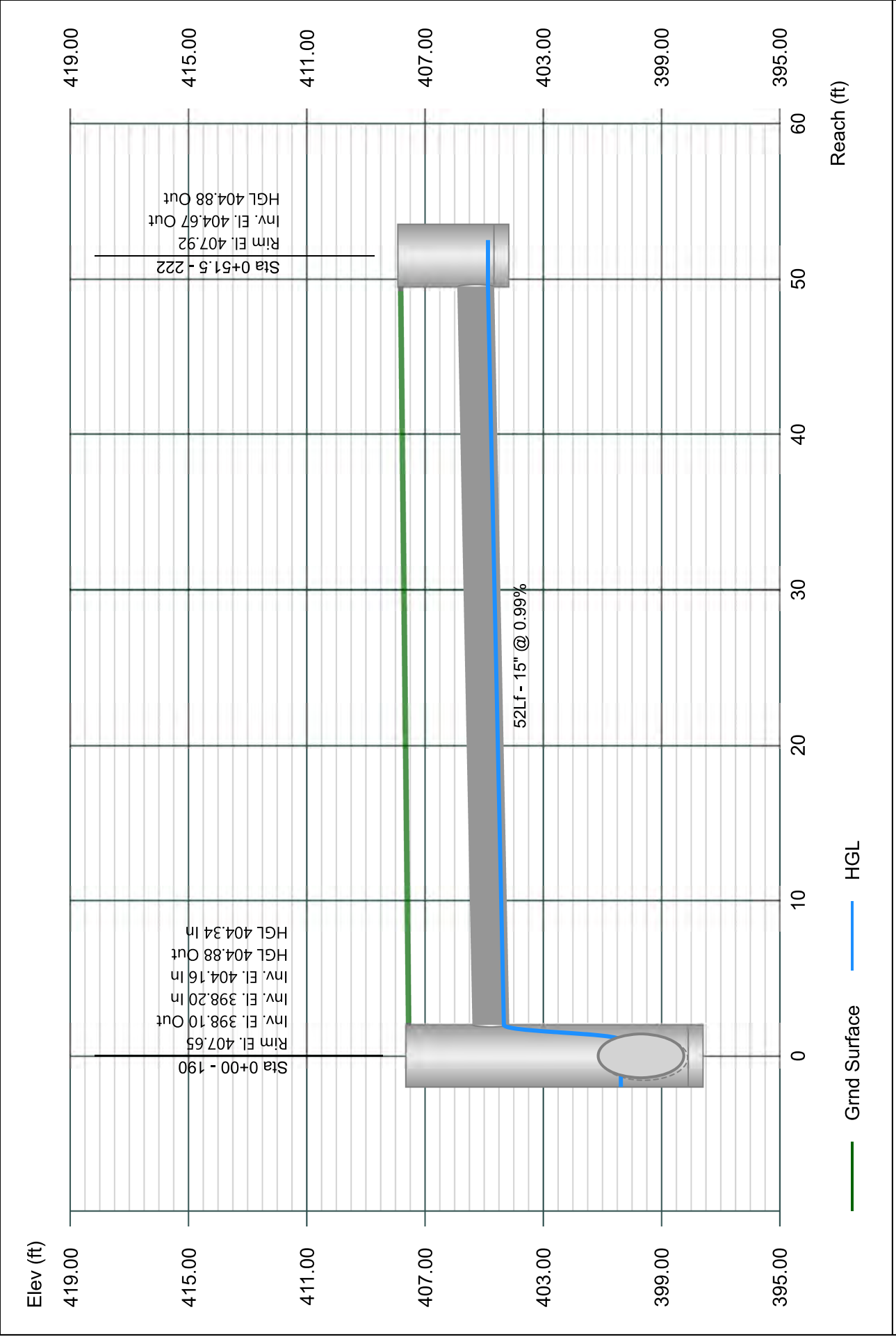

Line 124 - 223 TO 189

Stormwater Studio 2024 v 3.0.0.33

Project Name: Enter Project Name...

01-19-2024

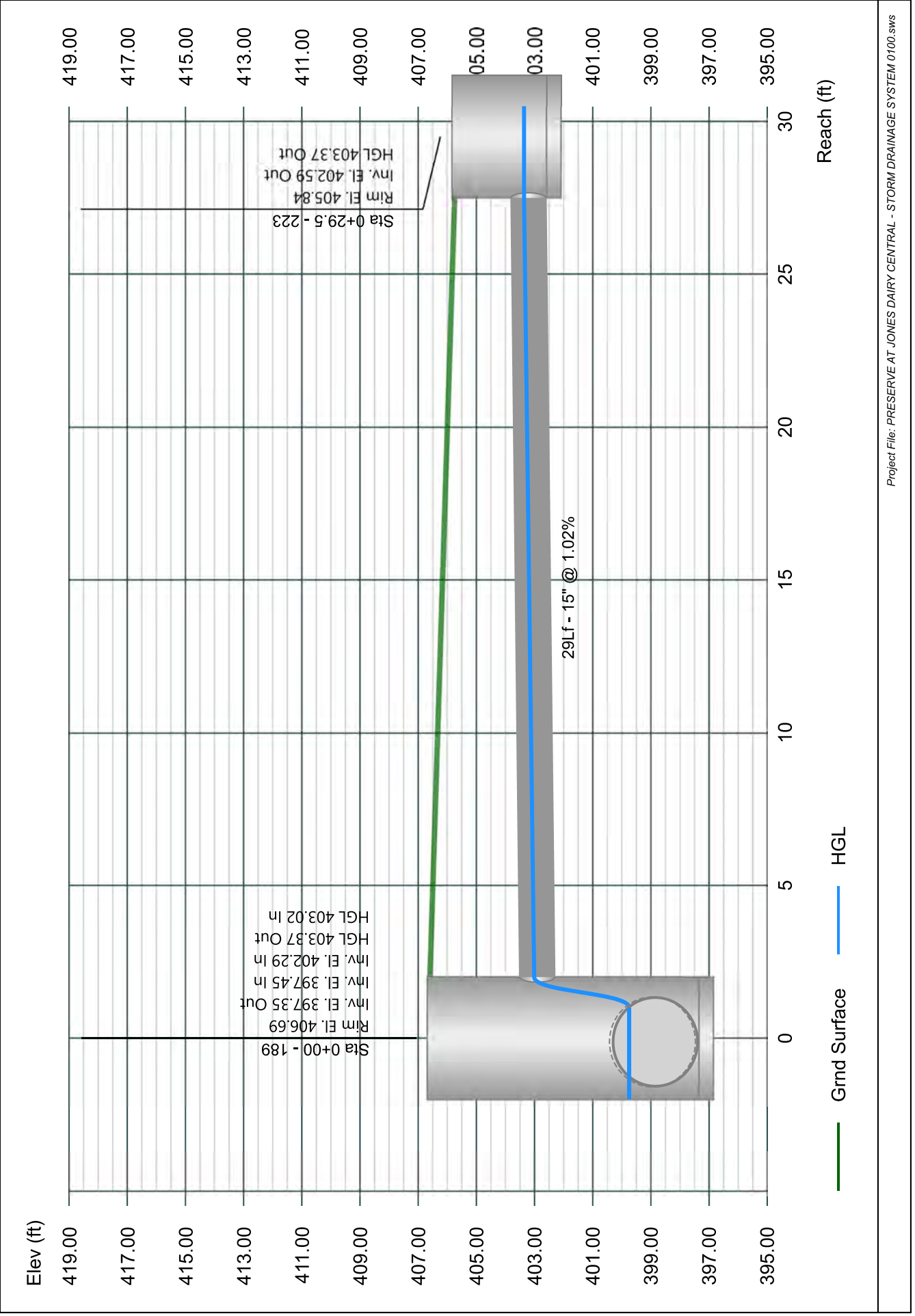

Line 125 - 314 TO 112

Stormwater Studio 2024 v 3.0.0.33

Project Name: Enter Project Name...

01-19-2024

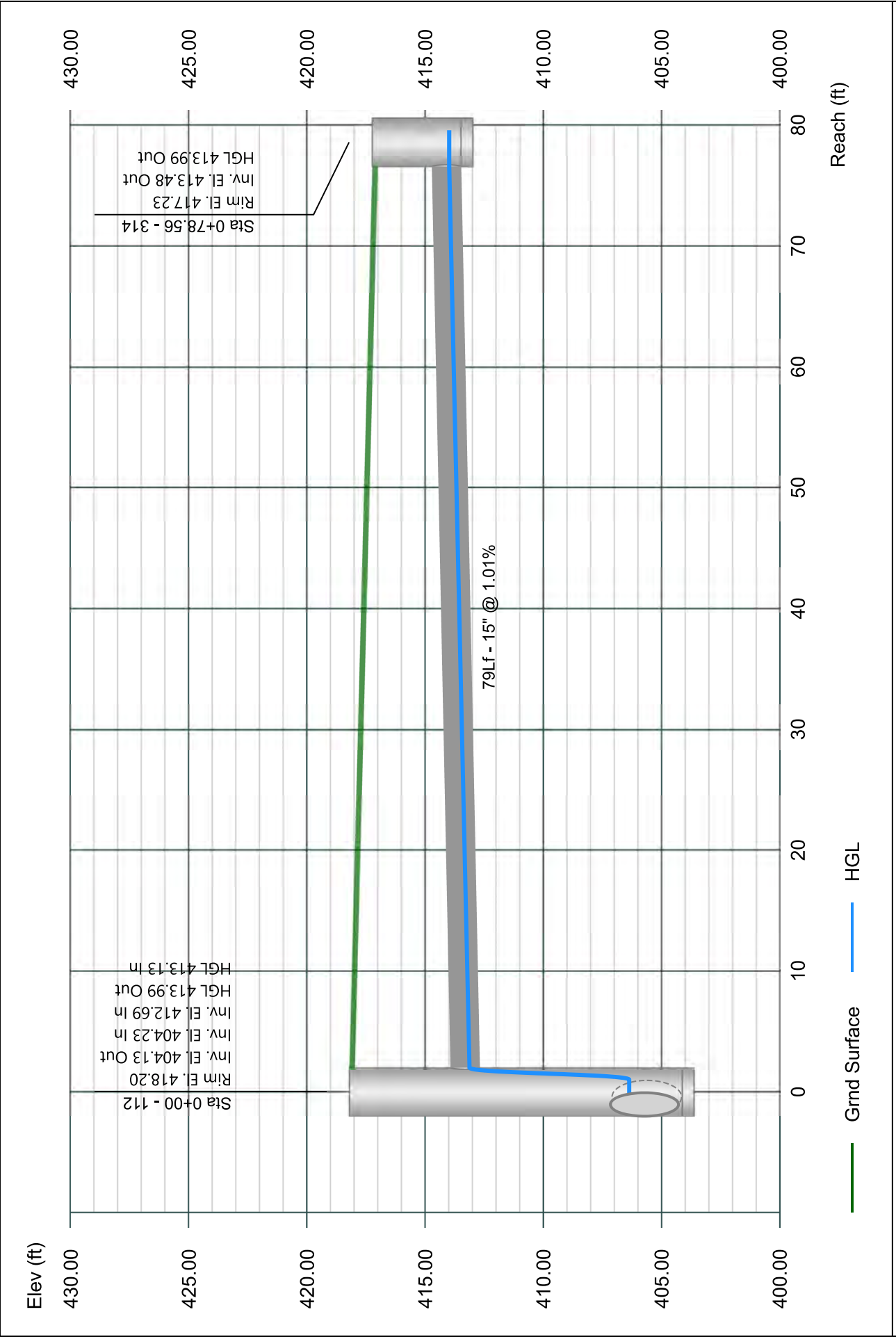

Line 126 - 213B TO 213A

Stormwater Studio 2024 v 3.0.0.33

Project Name: Enter Project Name...

01-19-2024

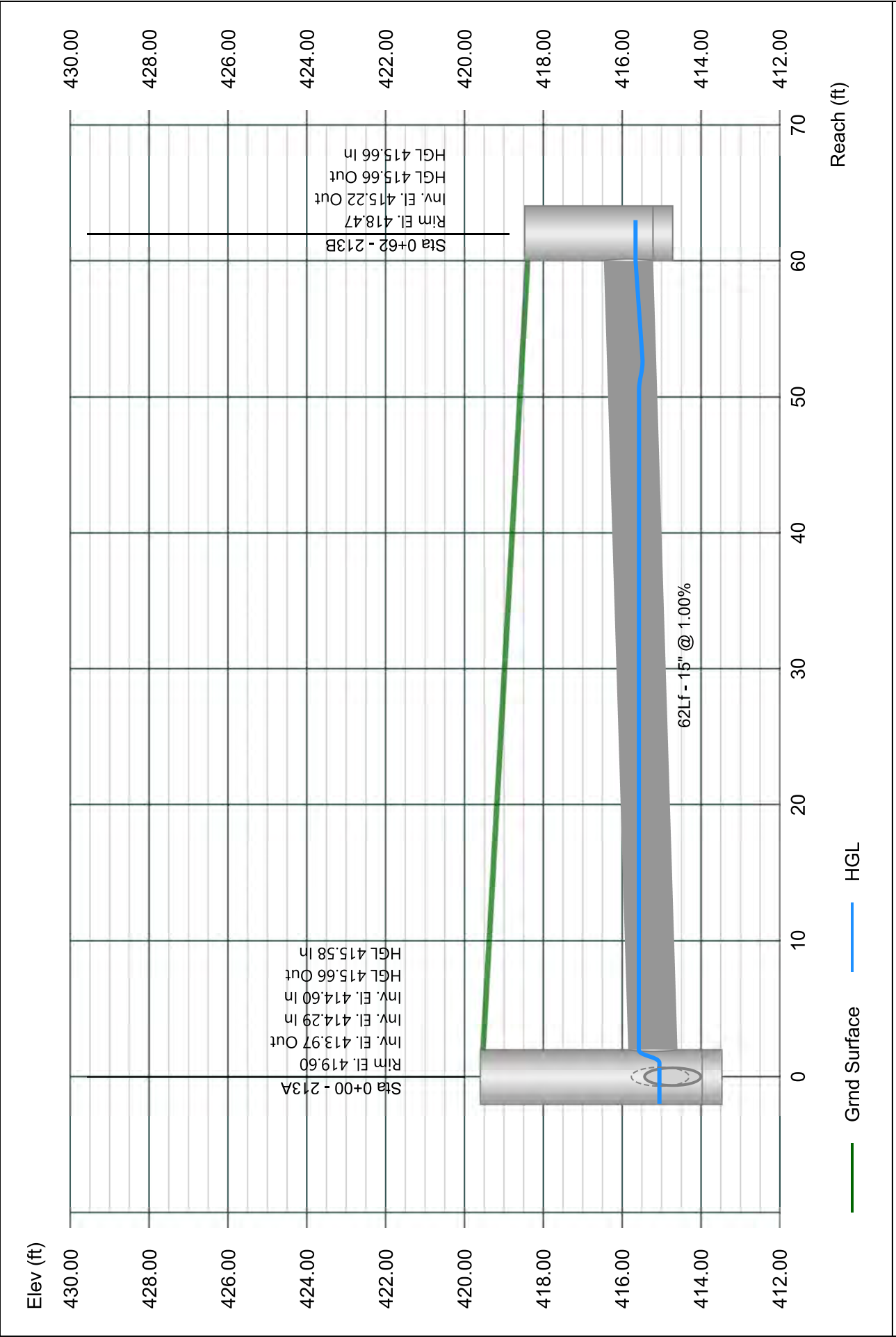

Line 1 - 301 TO 300

Stormwater Studio 2023 v 3.0.0.31

Project Name: Enter Project Name...

05-03-2023

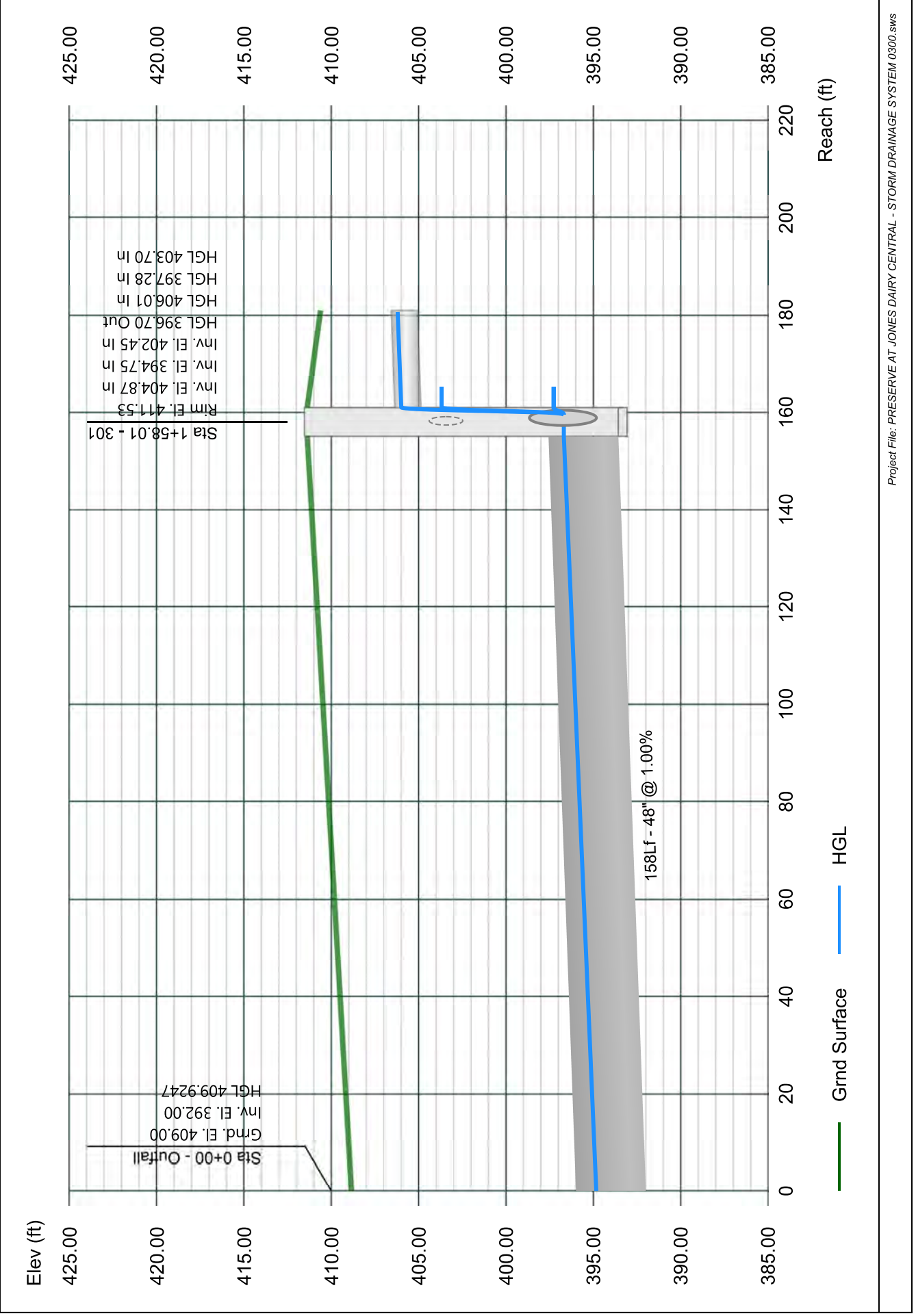

Line 2 - 318 TO 301

Stormwater Studio 2023 v 3.0.0.31

Project Name: Enter Project Name...

05-03-2023

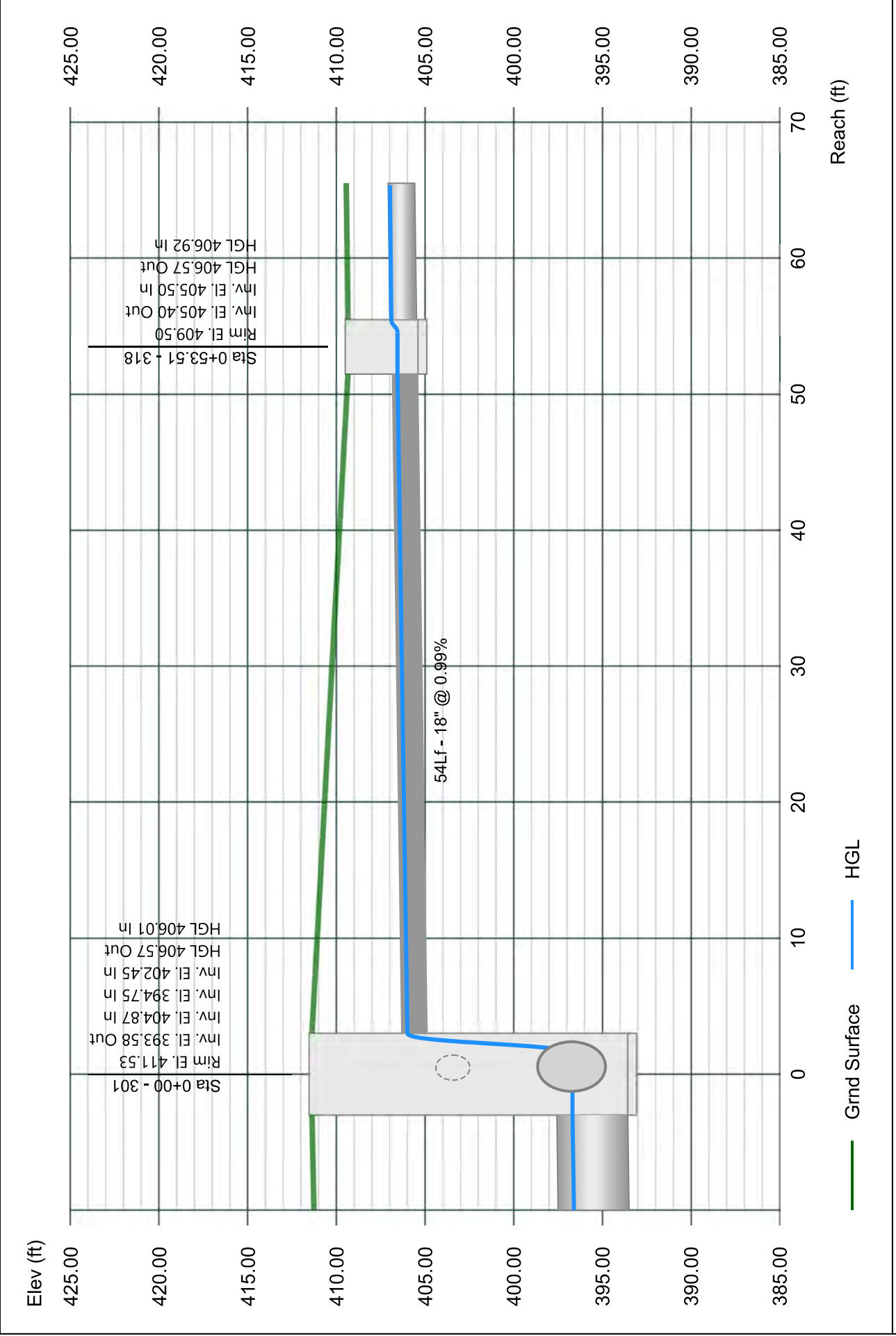

Line 3 - 319 TO 318

Stormwater Studio 2023 v 3.0.0.31

Project Name: Enter Project Name...

05-03-2023

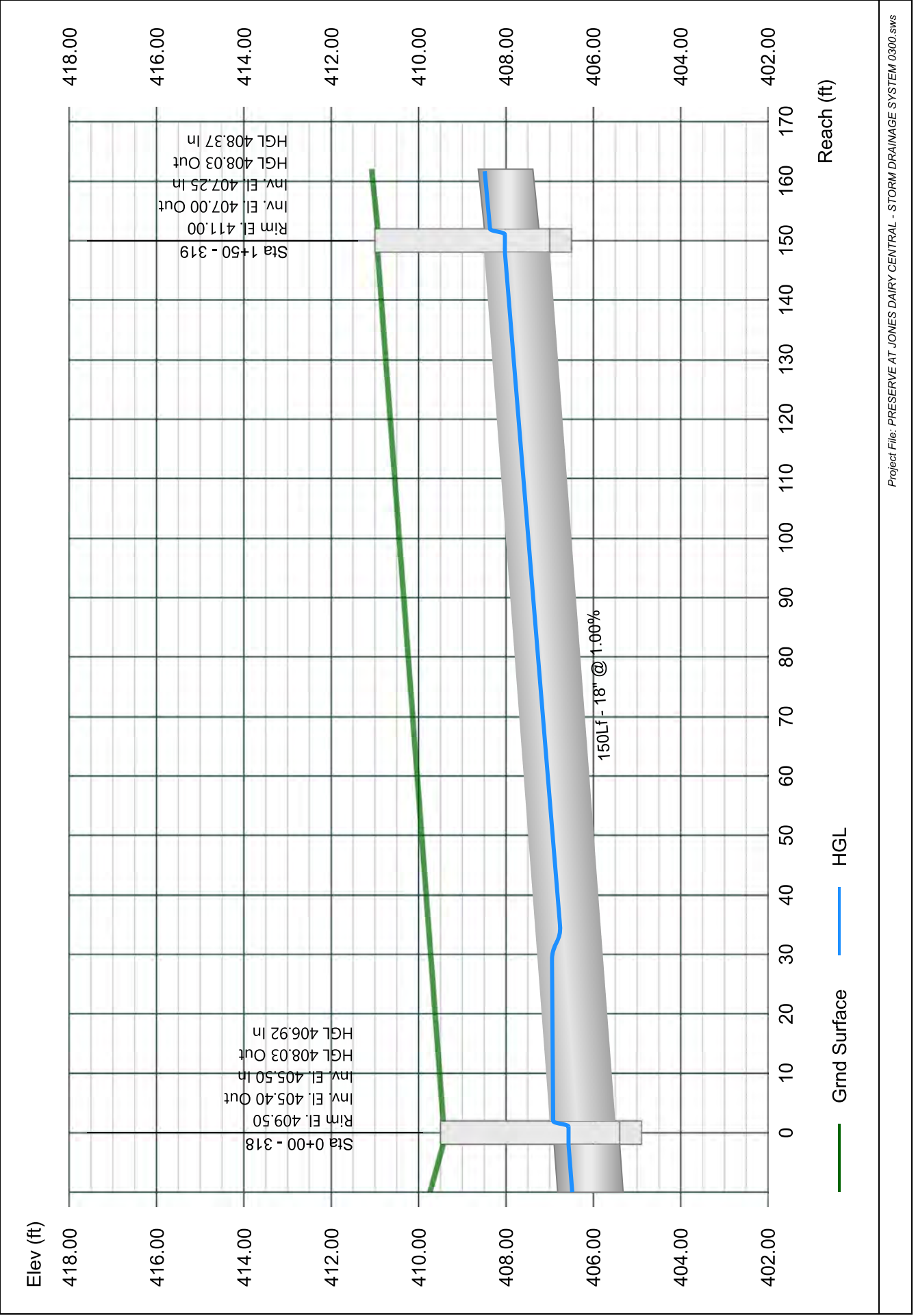

Line 4 - 320 TO 319

Stormwater Studio 2023 v 3.0.0.31

Project Name: Enter Project Name...

05-03-2023

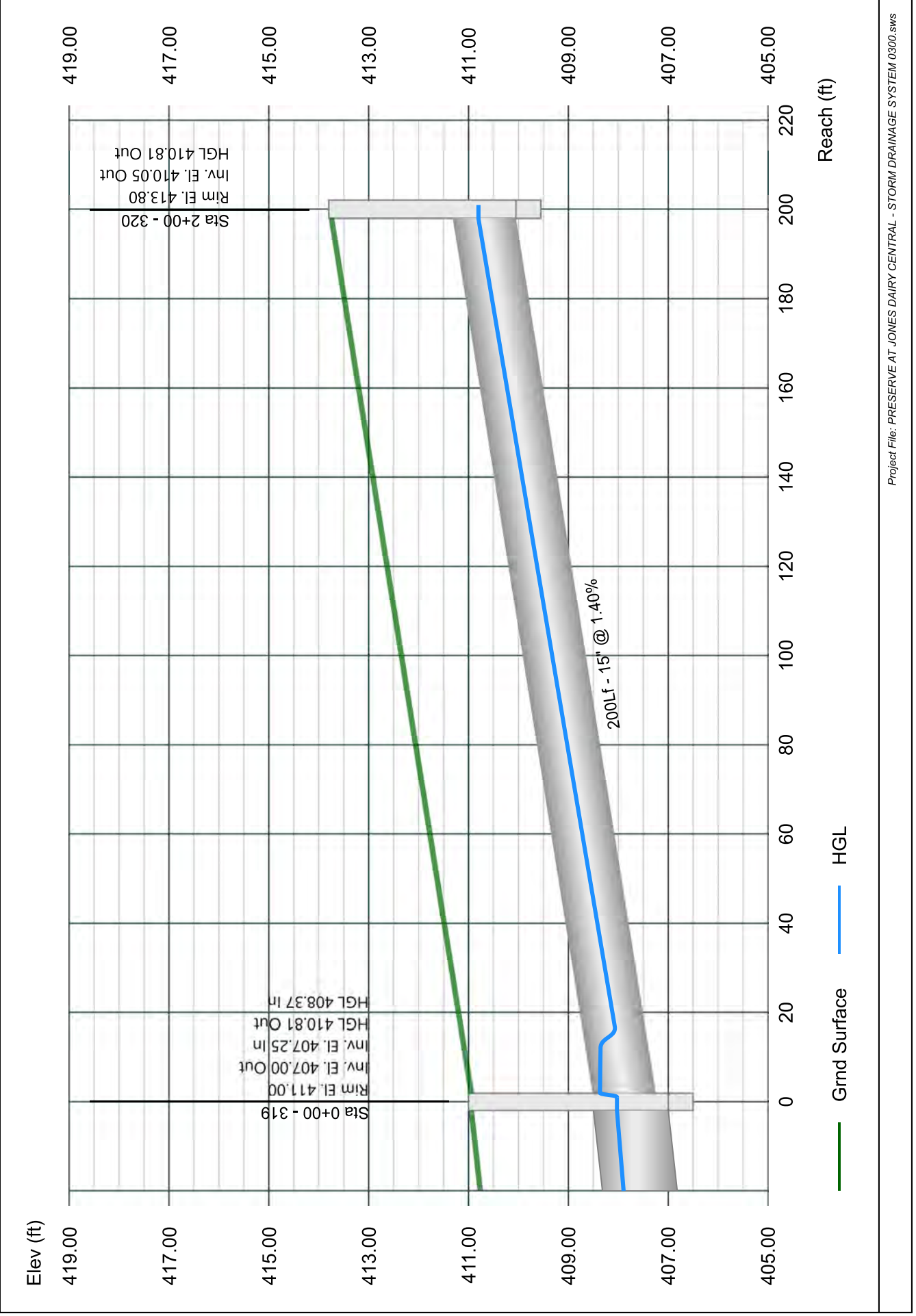

Line 5 - 302 TO 301

Stormwater Studio 2023 v 3.0.0.31

Project Name: Enter Project Name...

05-03-2023

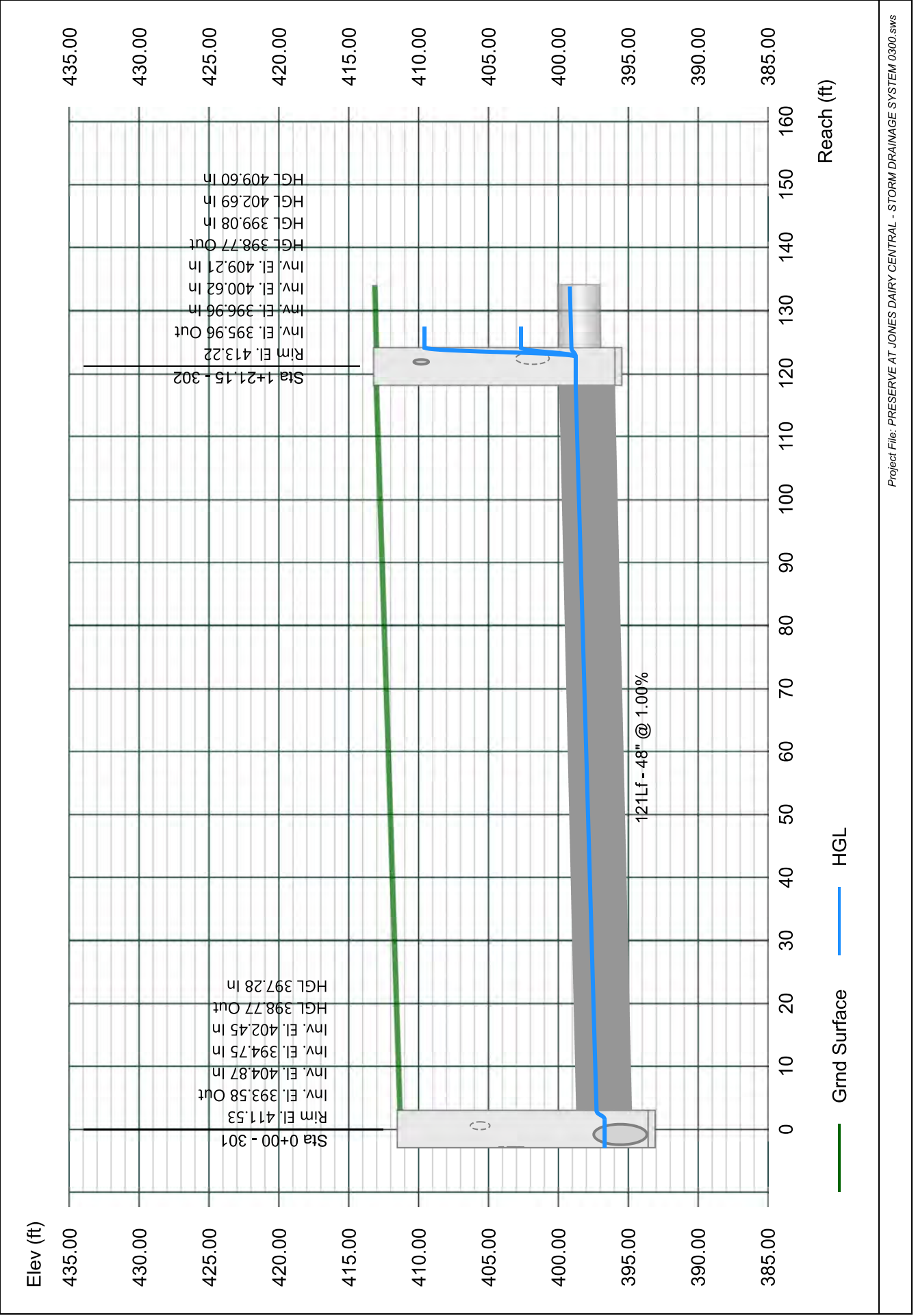

Line 6 - 303 TO 302

Stormwater Studio 2023 v 3.0.0.31

Project Name: Enter Project Name...

05-03-2023

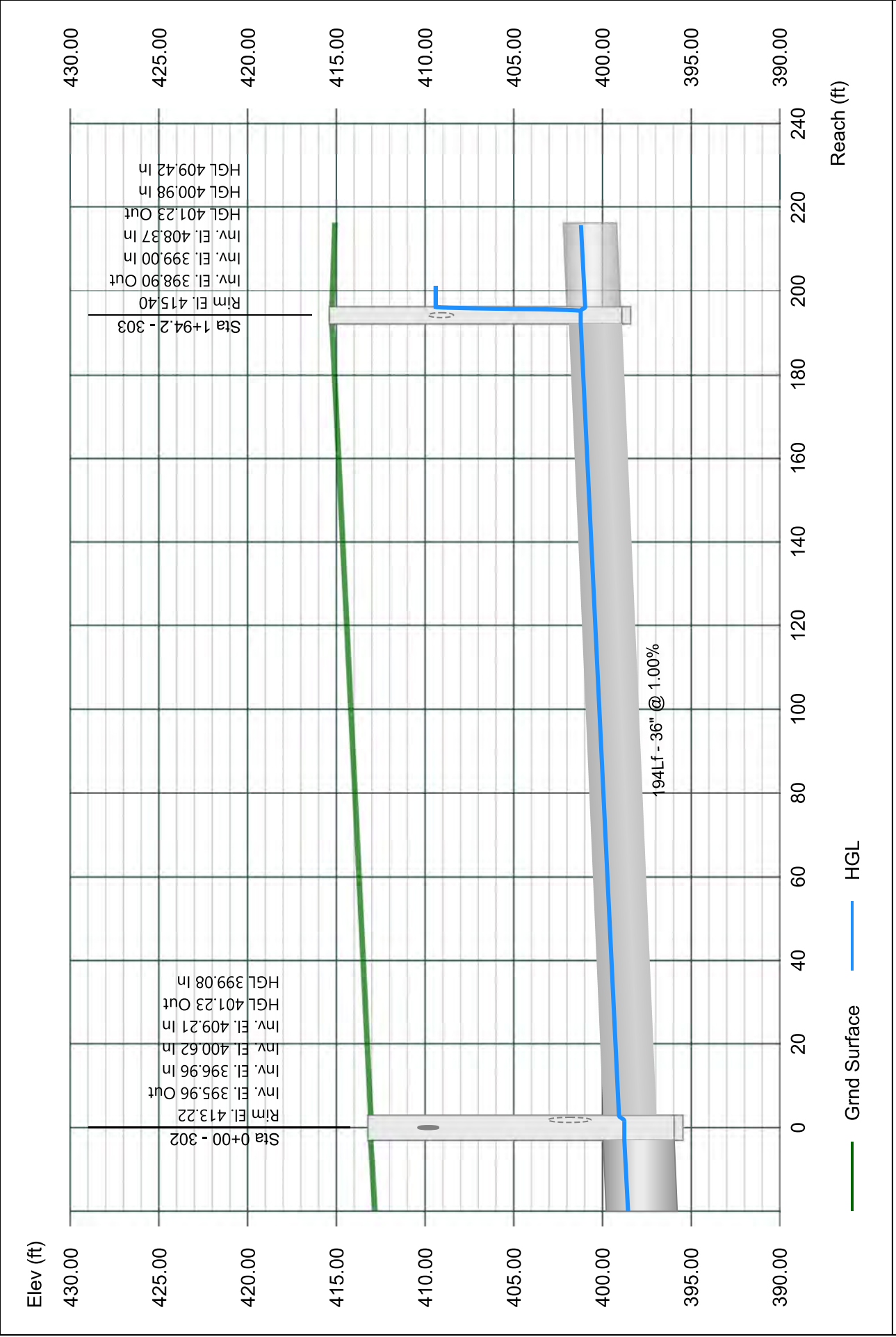

Line 7 - 304 TO 303

Stormwater Studio 2023 v 3.0.0.31

Project Name: Enter Project Name...

05-03-2023

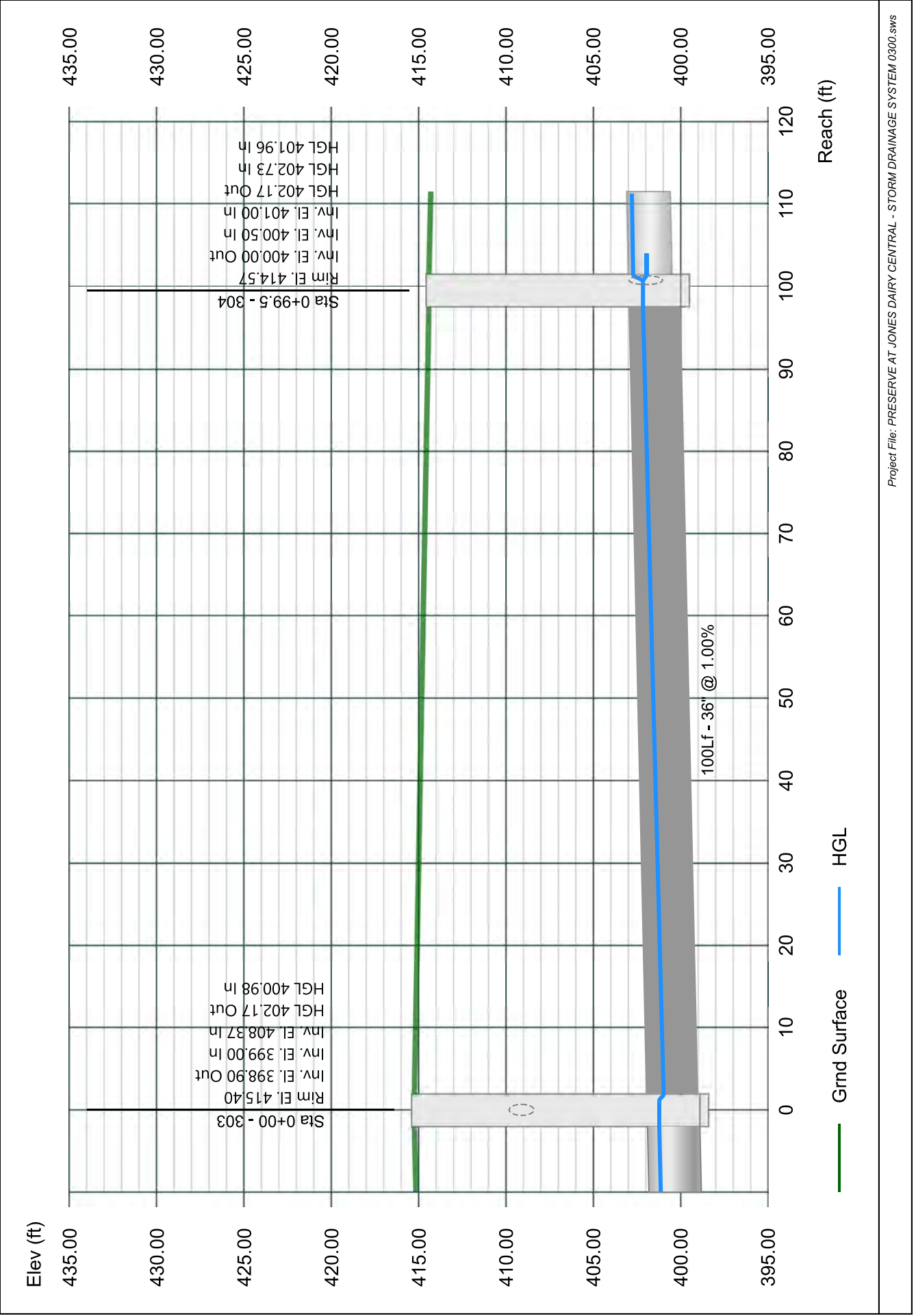

Line 8 - 305 TO 304

Stormwater Studio 2023 v 3.0.0.31

Project Name: Enter Project Name...

05-03-2023

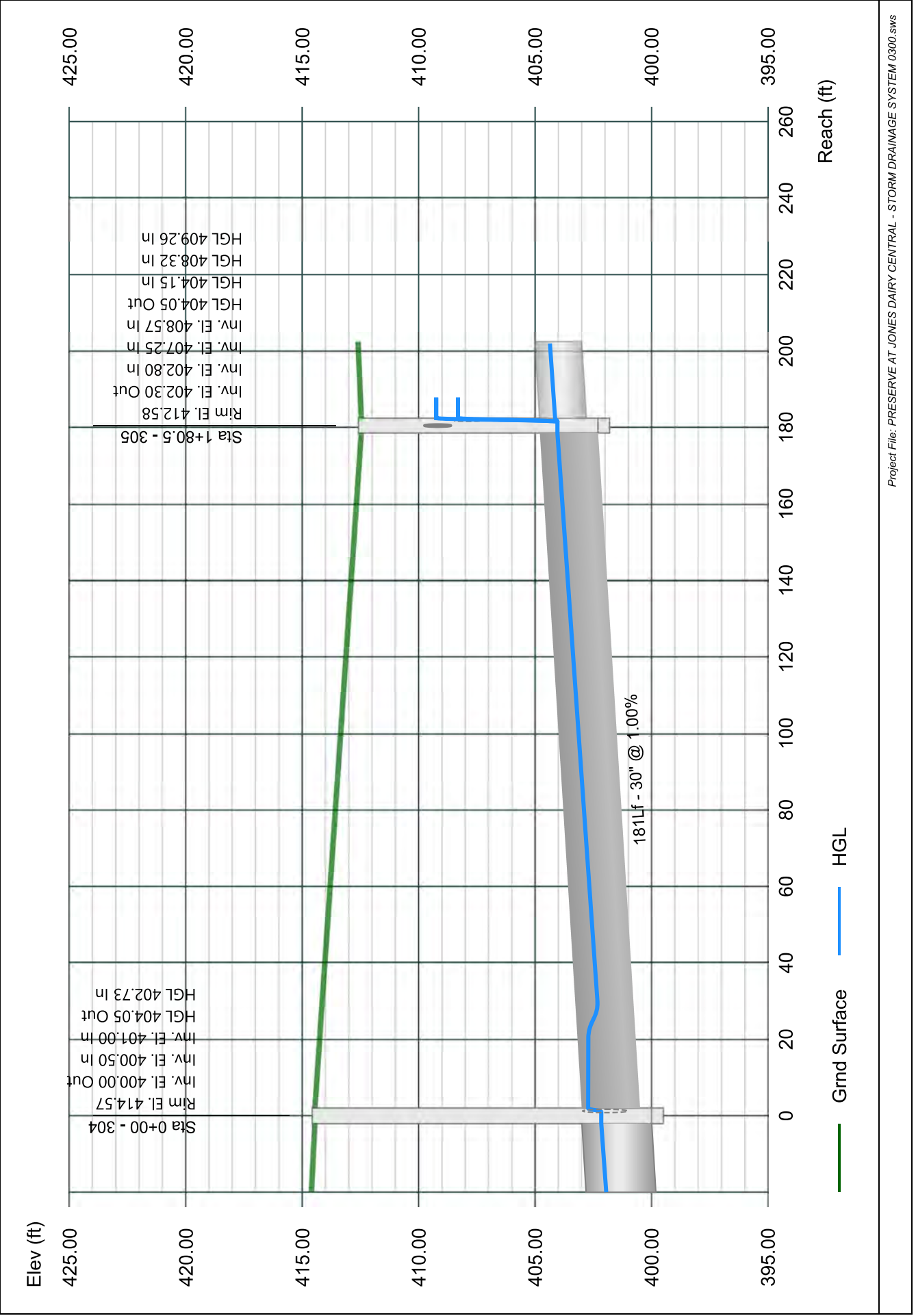

Line 9 - 306 TO 305

Stormwater Studio 2023 v 3.0.0.31

Project Name: Enter Project Name...

05-03-2023

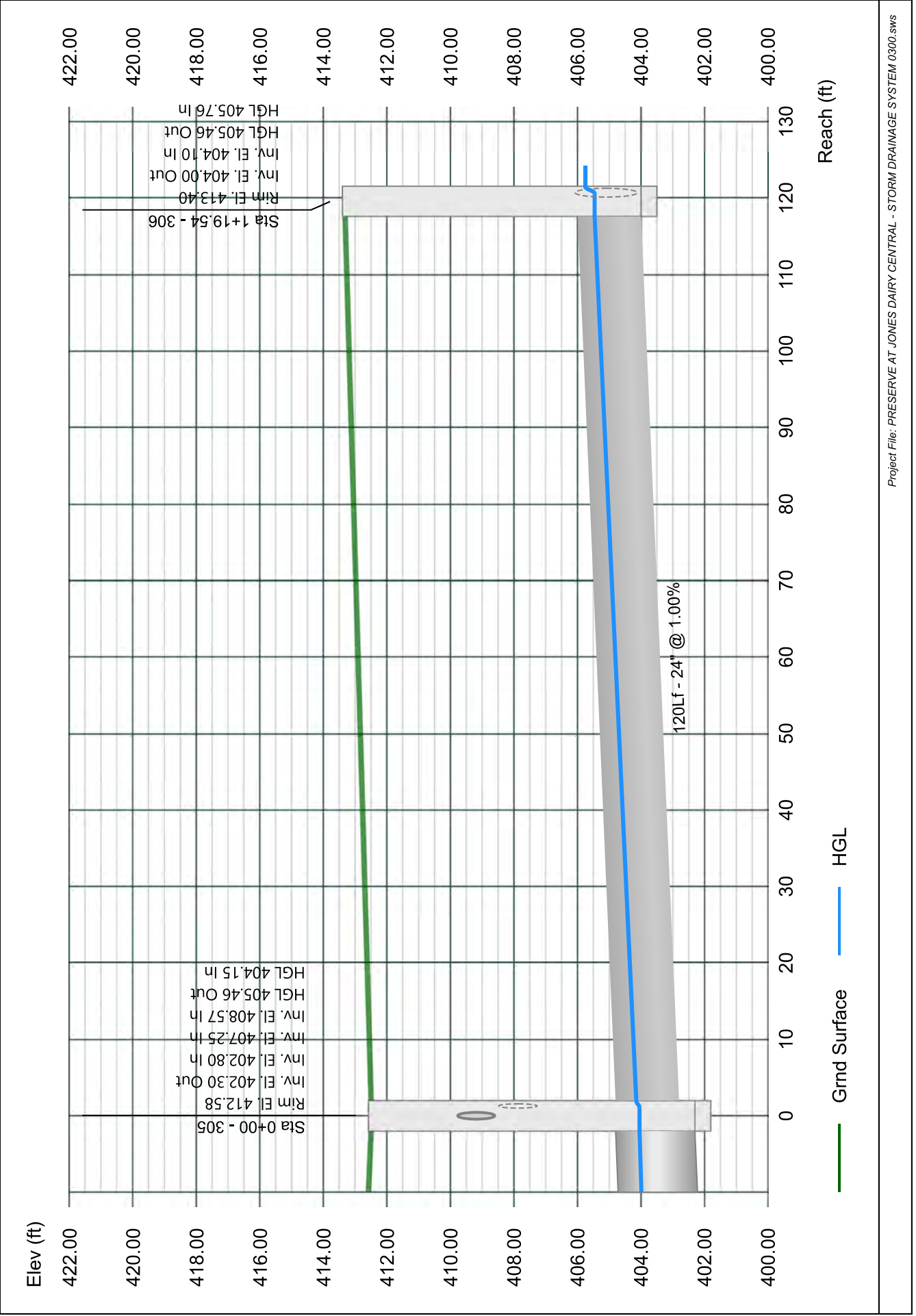

Line 10 - 307 TO 306

Stormwater Studio 2023 v 3.0.0.31

Project Name: Enter Project Name...

05-03-2023

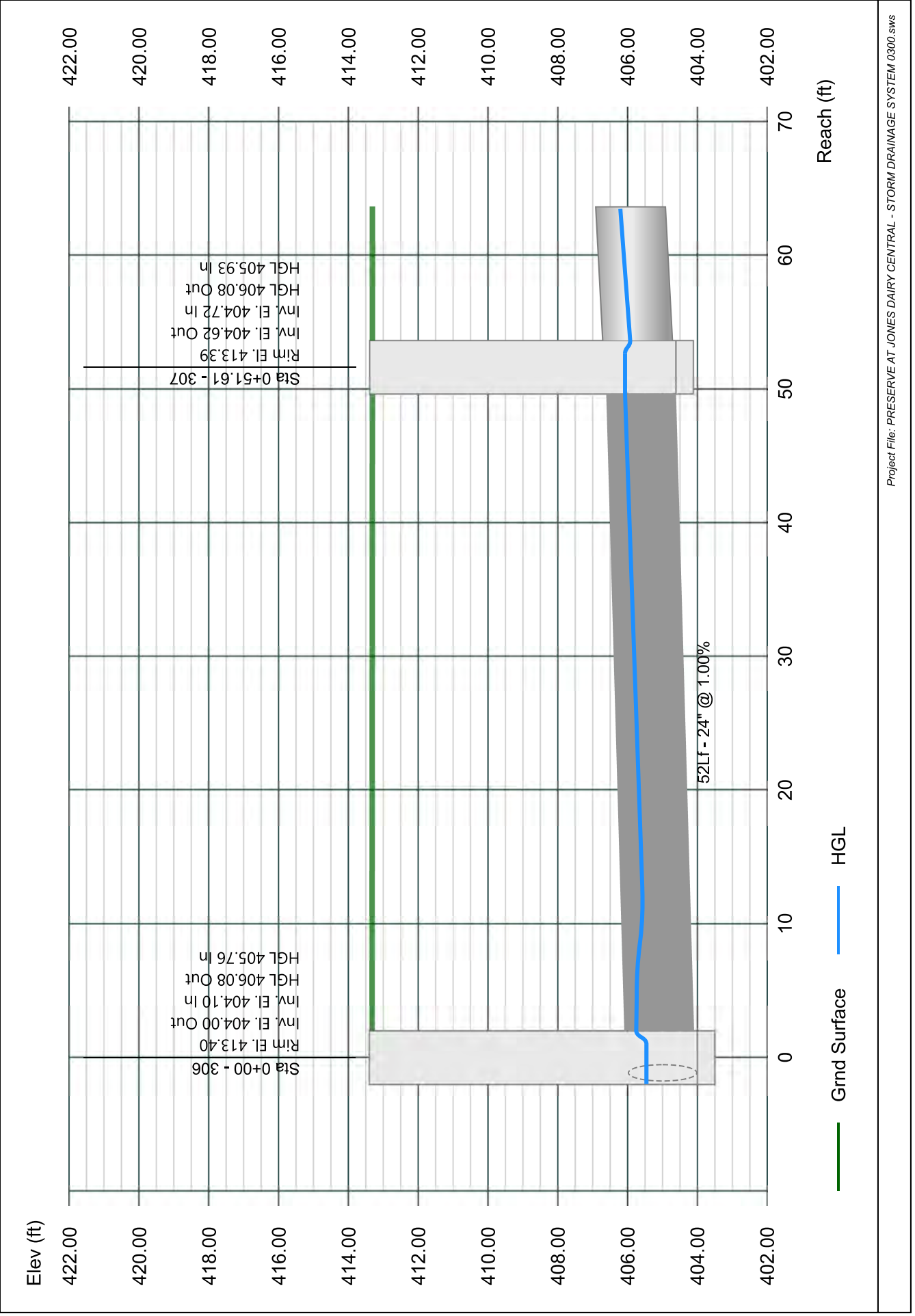

Line 11 - 308 TO 307

Stormwater Studio 2023 v 3.0.0.31

Project Name: Enter Project Name...

05-03-2023

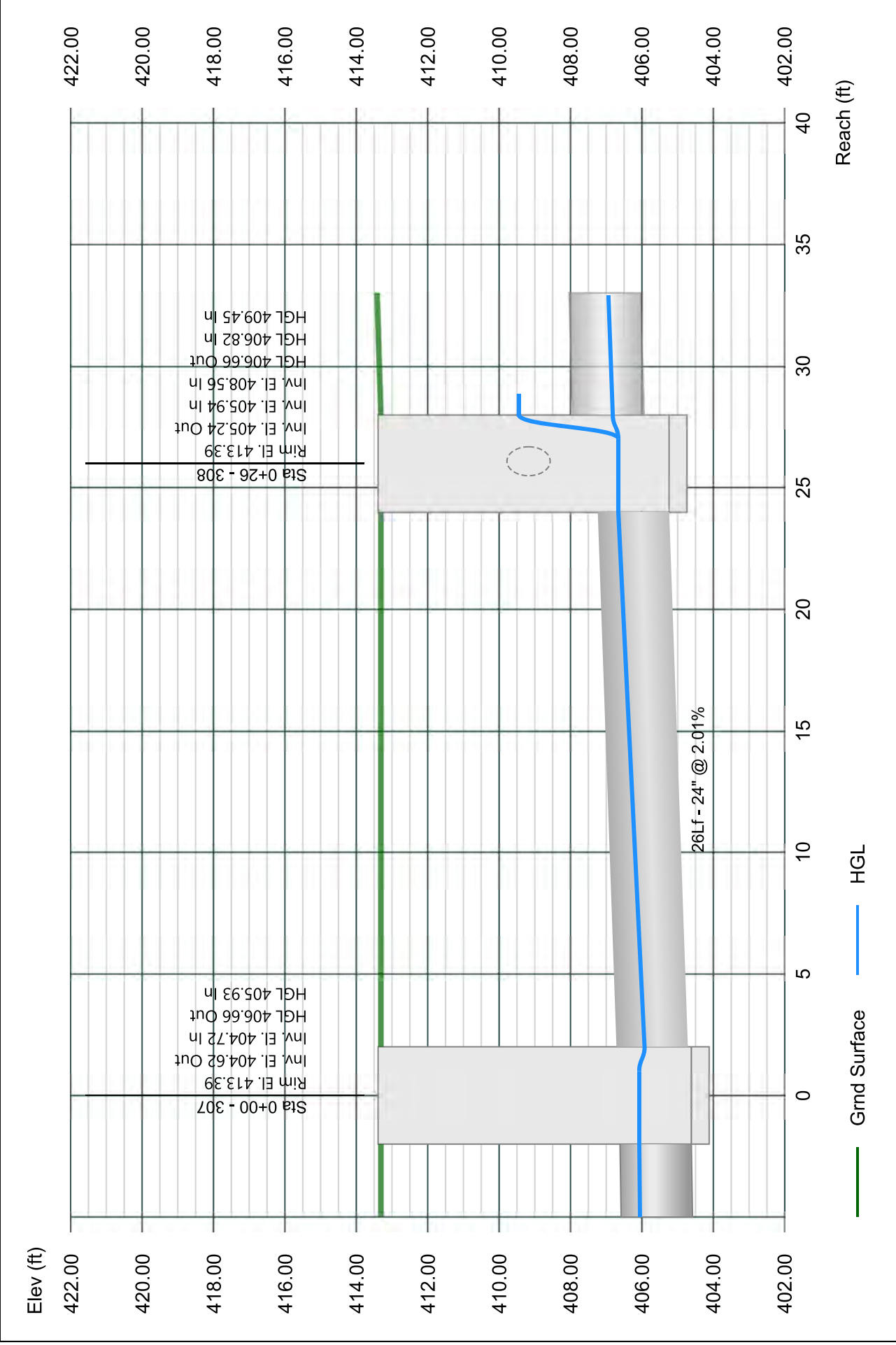

Line 12 - 309 TO 308

Stormwater Studio 2023 v 3.0.0.31

Project Name: Enter Project Name...

05-03-2023

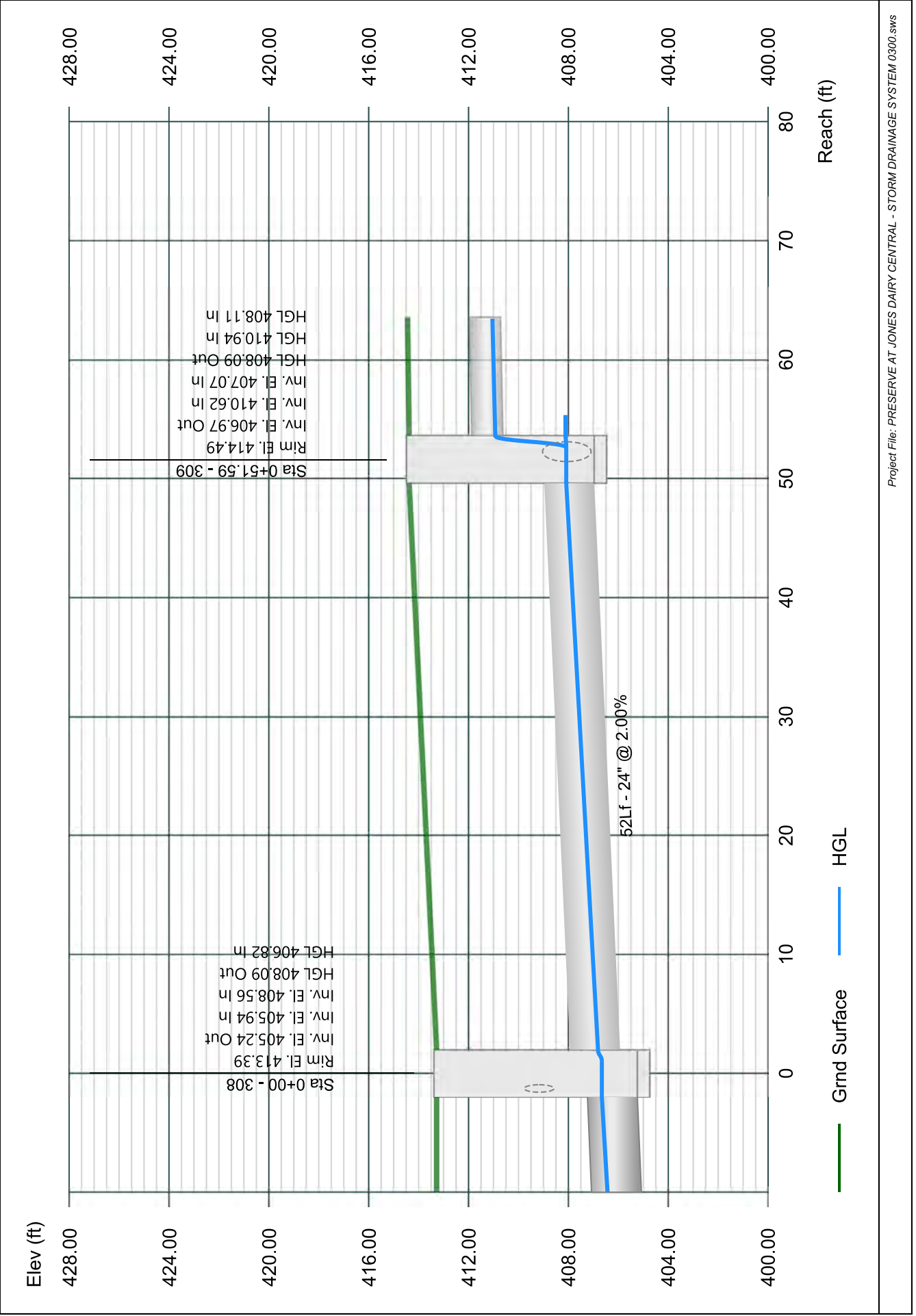

Line 13 - 363 TO 309

Stormwater Studio 2023 v 3.0.0.31

Project Name: Enter Project Name...

05-03-2023

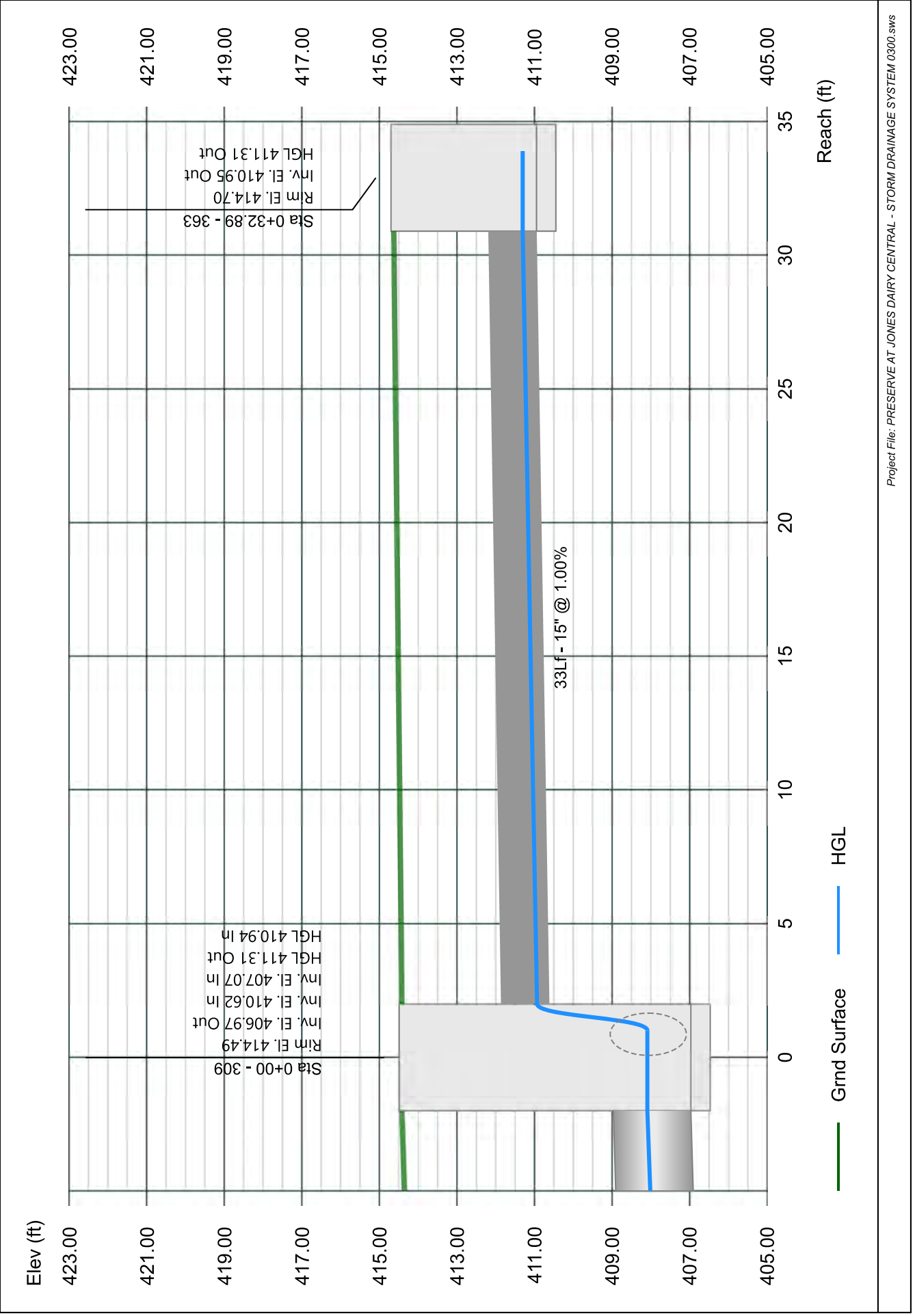

Line 14 - 310 TO 309

Stormwater Studio 2023 v 3.0.0.31

Project Name: Enter Project Name...

05-03-2023

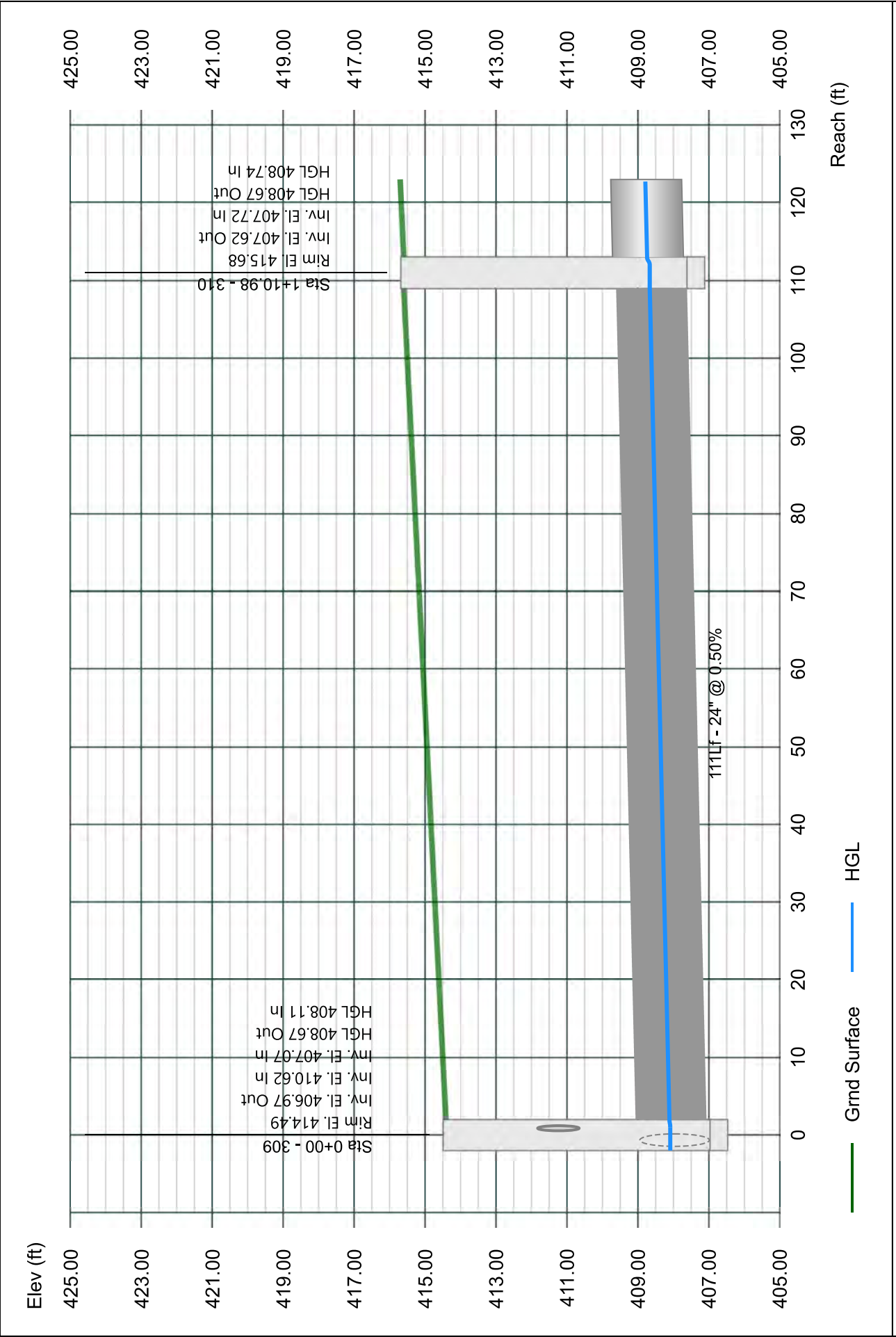

Line 15 - 311 TO 310

Stormwater Studio 2023 v 3.0.0.31

Project Name: Enter Project Name...

05-03-2023

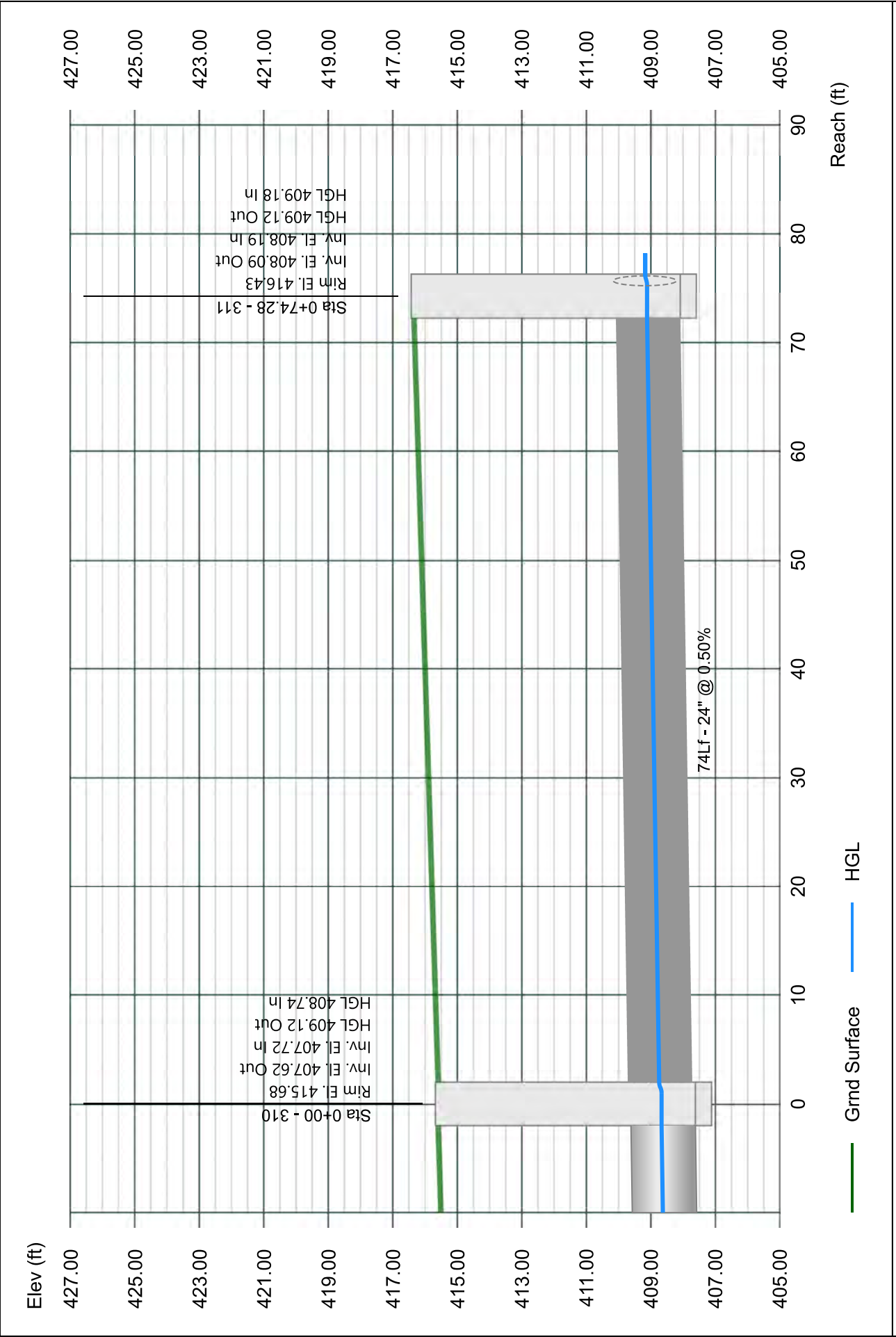

Line 16 - 312 TO 311

Stormwater Studio 2023 v 3.0.0.31

Project Name: Enter Project Name...

05-03-2023

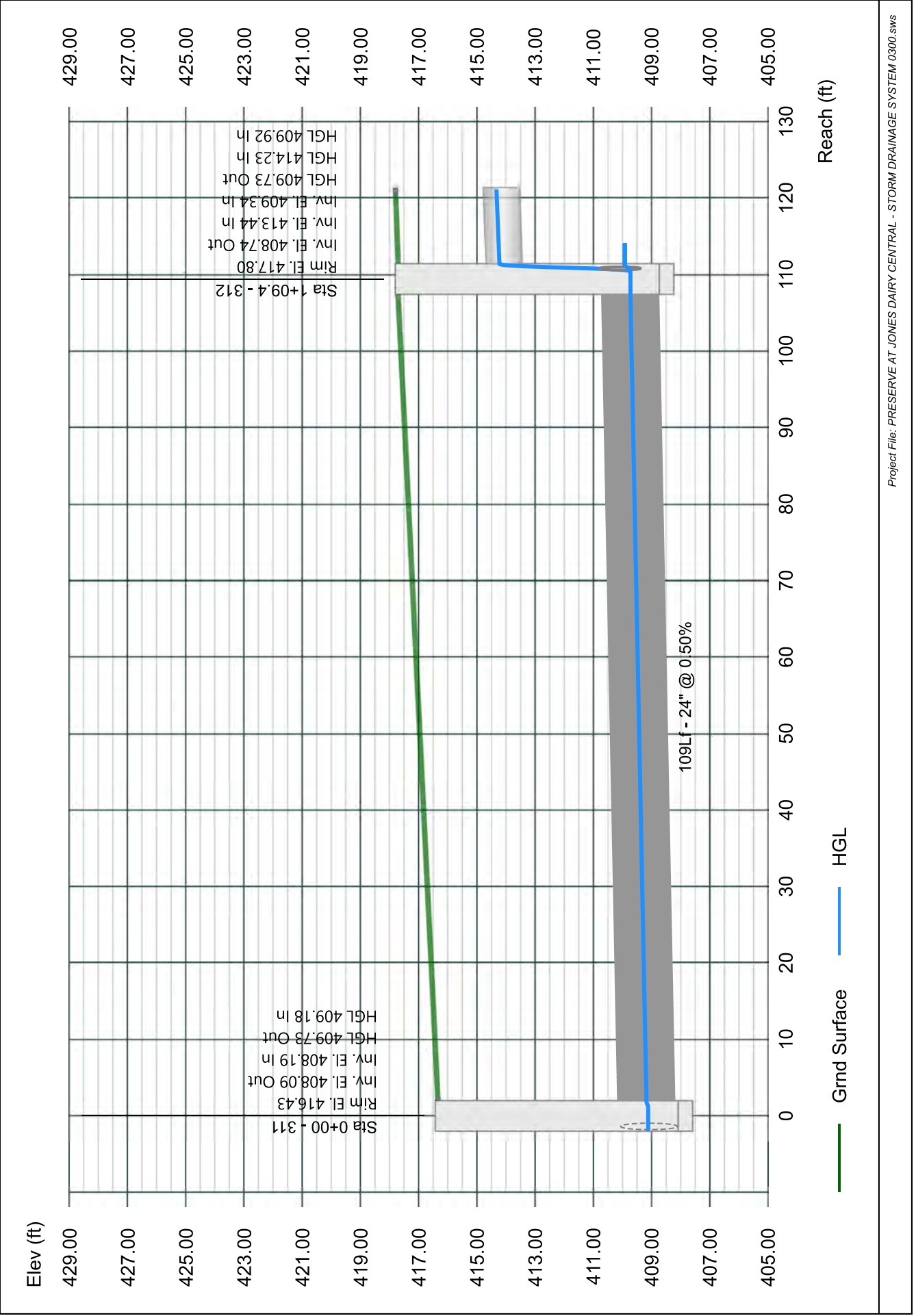

Line 17 - 364 TO 312

Stormwater Studio 2023 v 3.0.0.31

Project Name: Enter Project Name...

05-03-2023

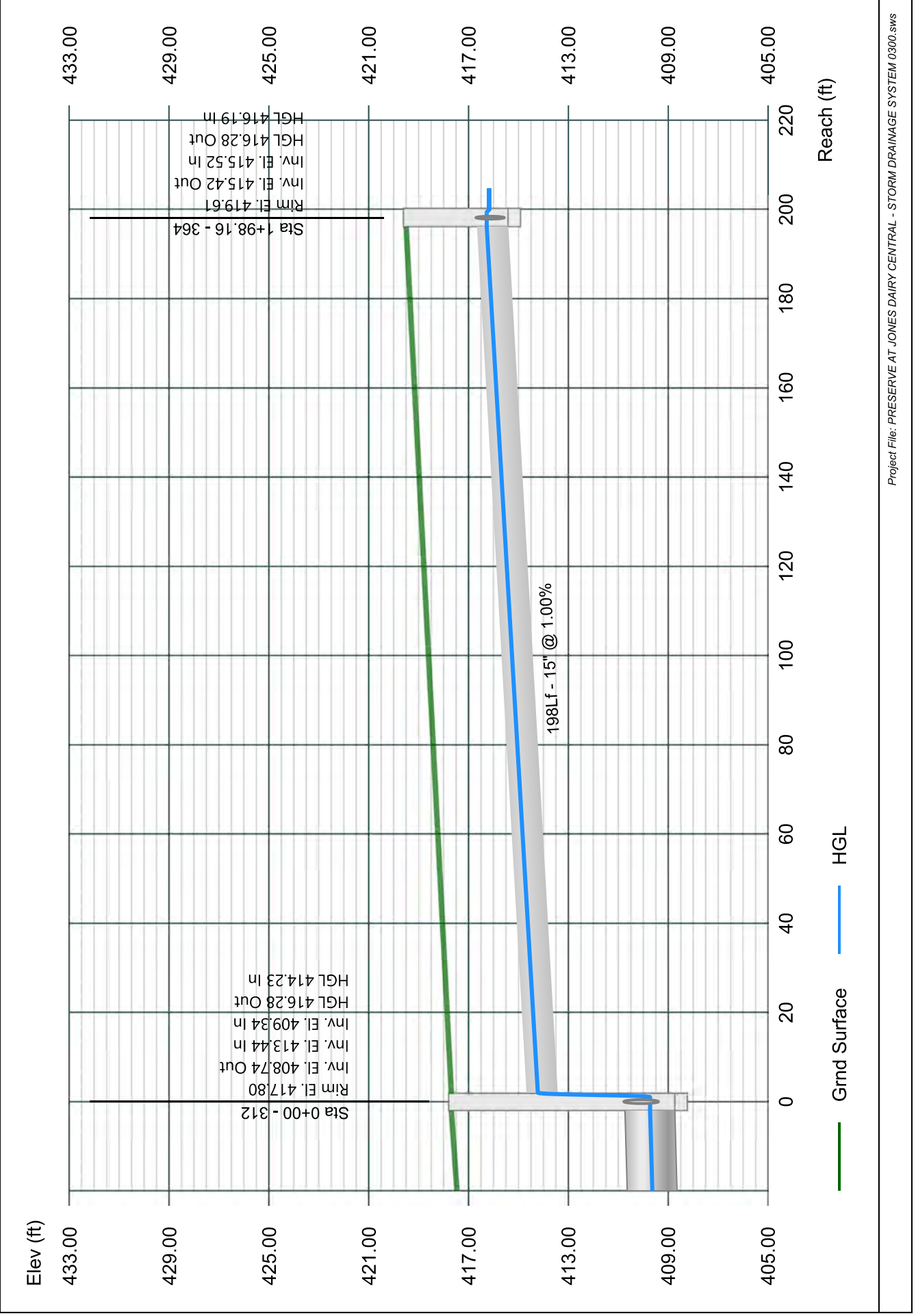

Line 18 - 365 TO 364

Stormwater Studio 2023 v 3.0.0.31

Project Name: Enter Project Name...

05-03-2023

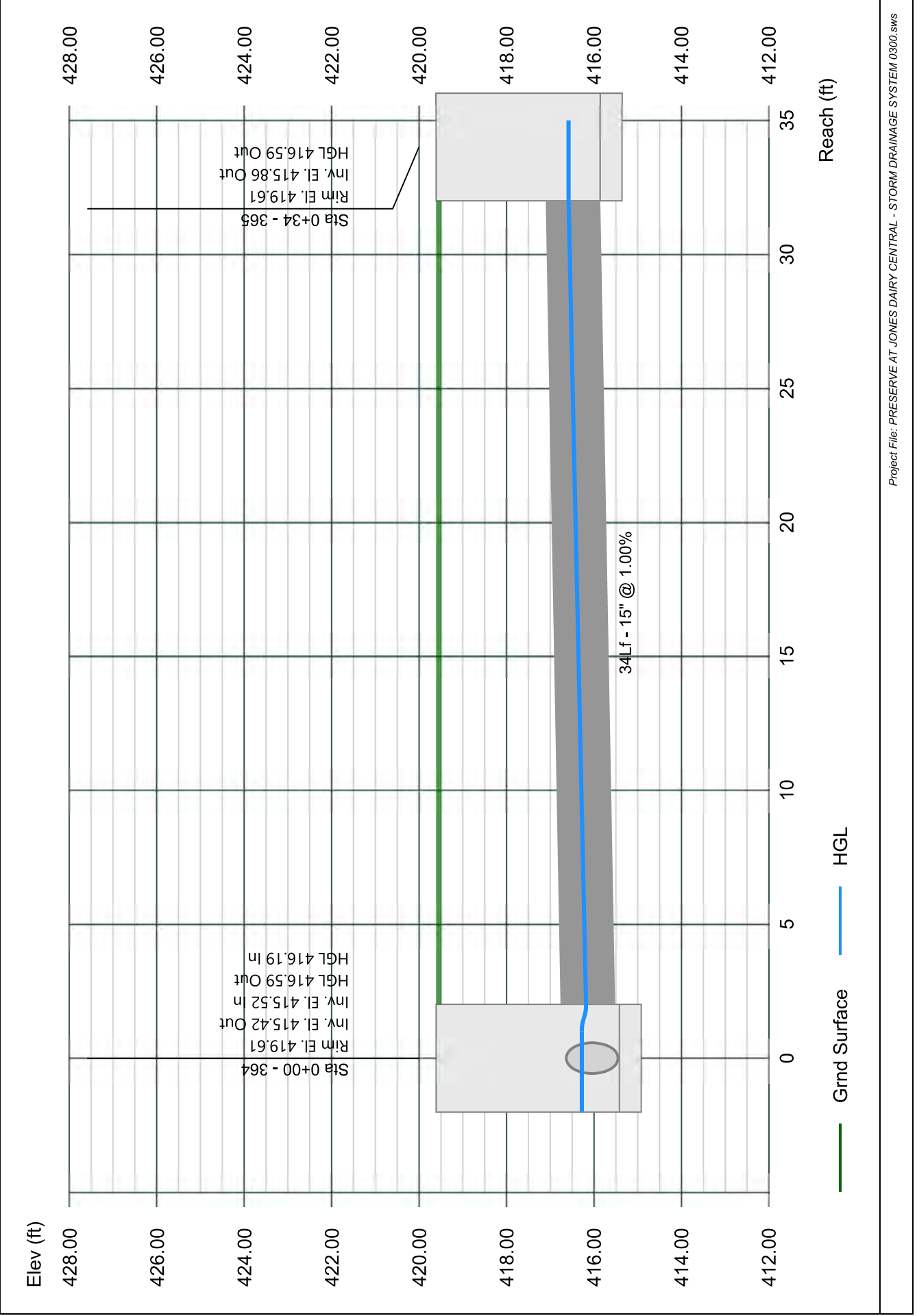

Line 19 - 313 TO 312

Stormwater Studio 2023 v 3.0.0.31

Project Name: Enter Project Name...

05-03-2023

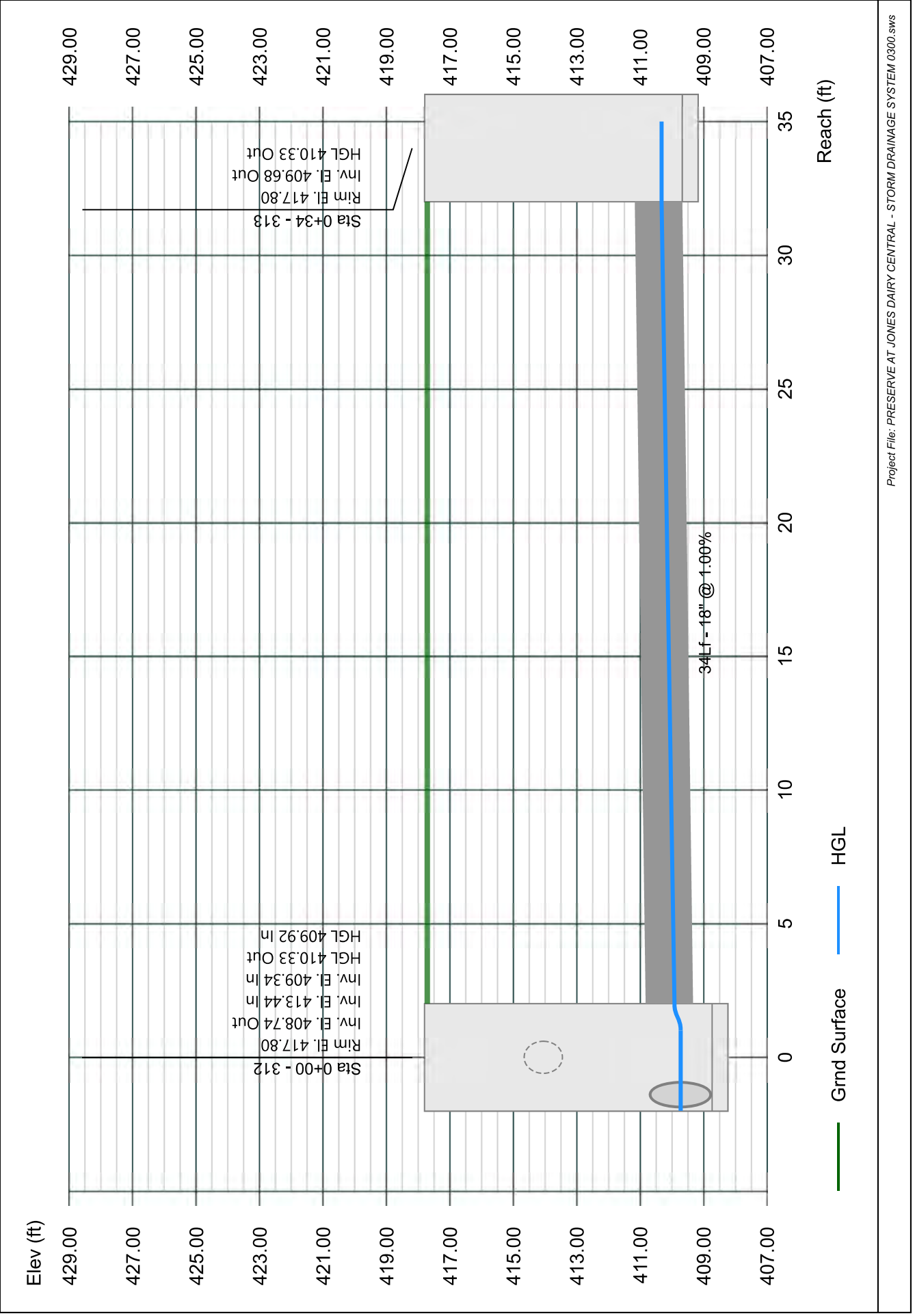

Line 20 - 360 TO 308

Stormwater Studio 2023 v 3.0.0.31

Project Name: Enter Project Name...

05-03-2023

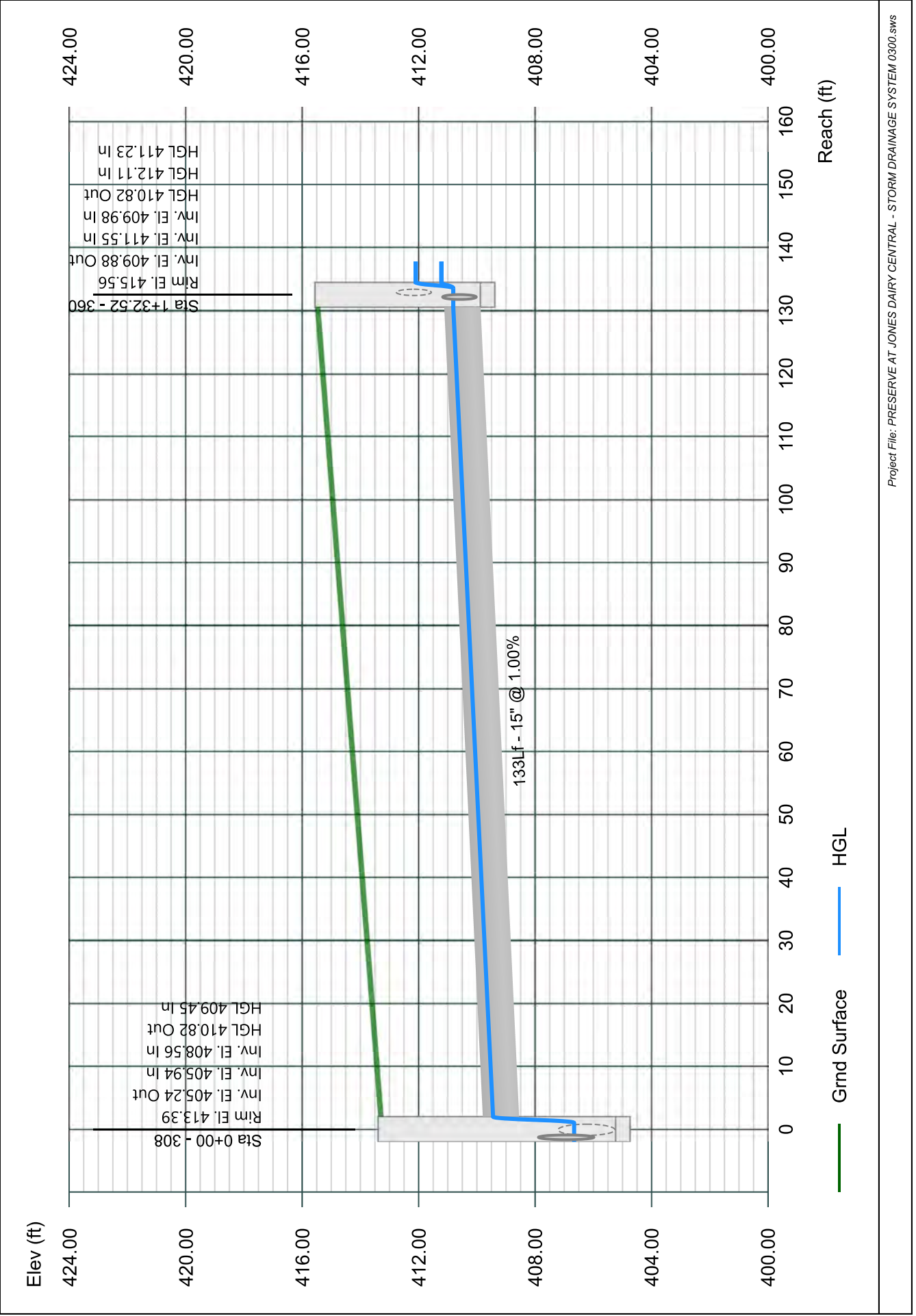

Line 21 - 361 TO 360

Stormwater Studio 2023 v 3.0.0.31

Project Name: Enter Project Name...

05-03-2023

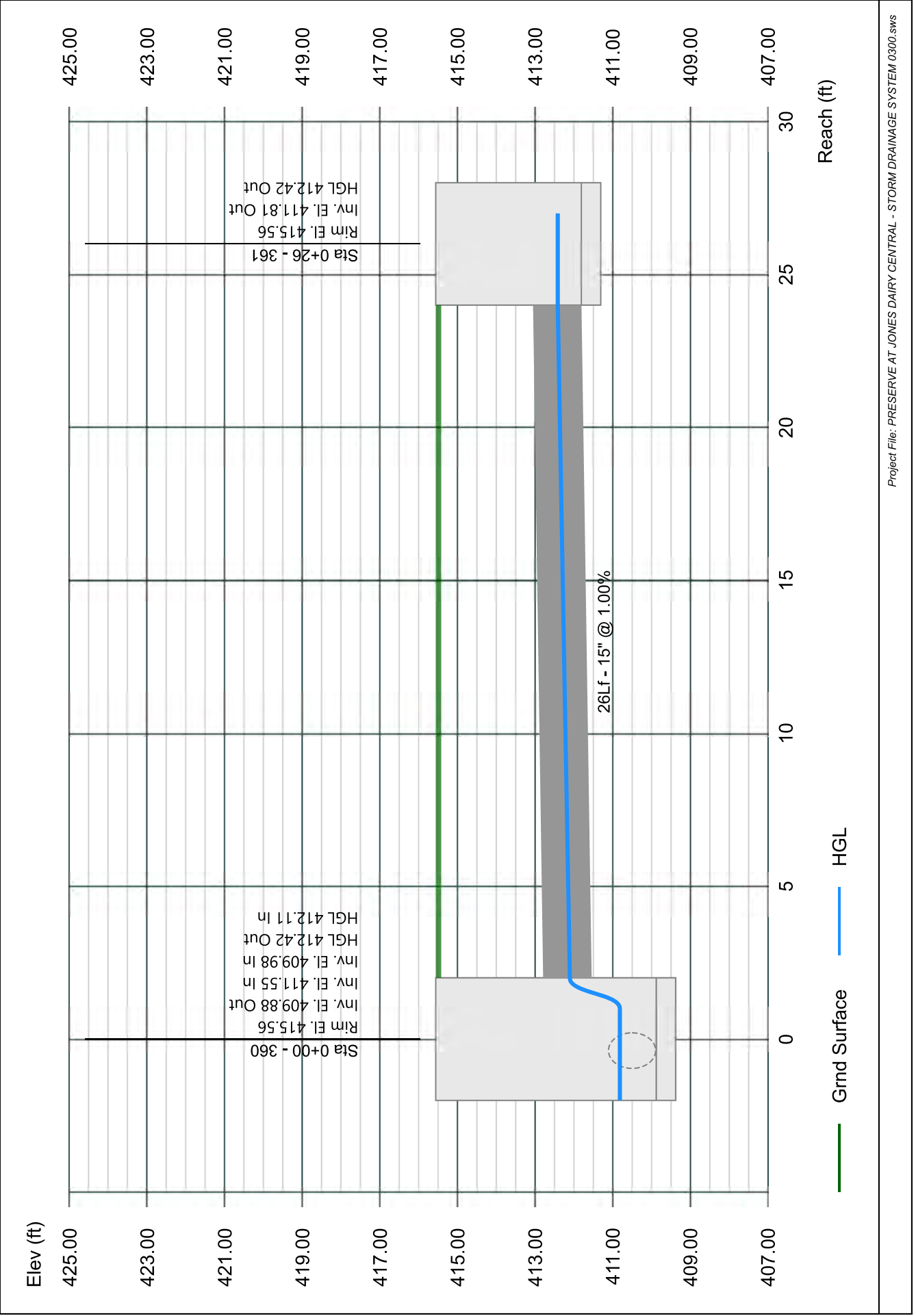

Line 22 - 362 TO 360

Stormwater Studio 2023 v 3.0.0.31

Project Name: Enter Project Name...

05-03-2023

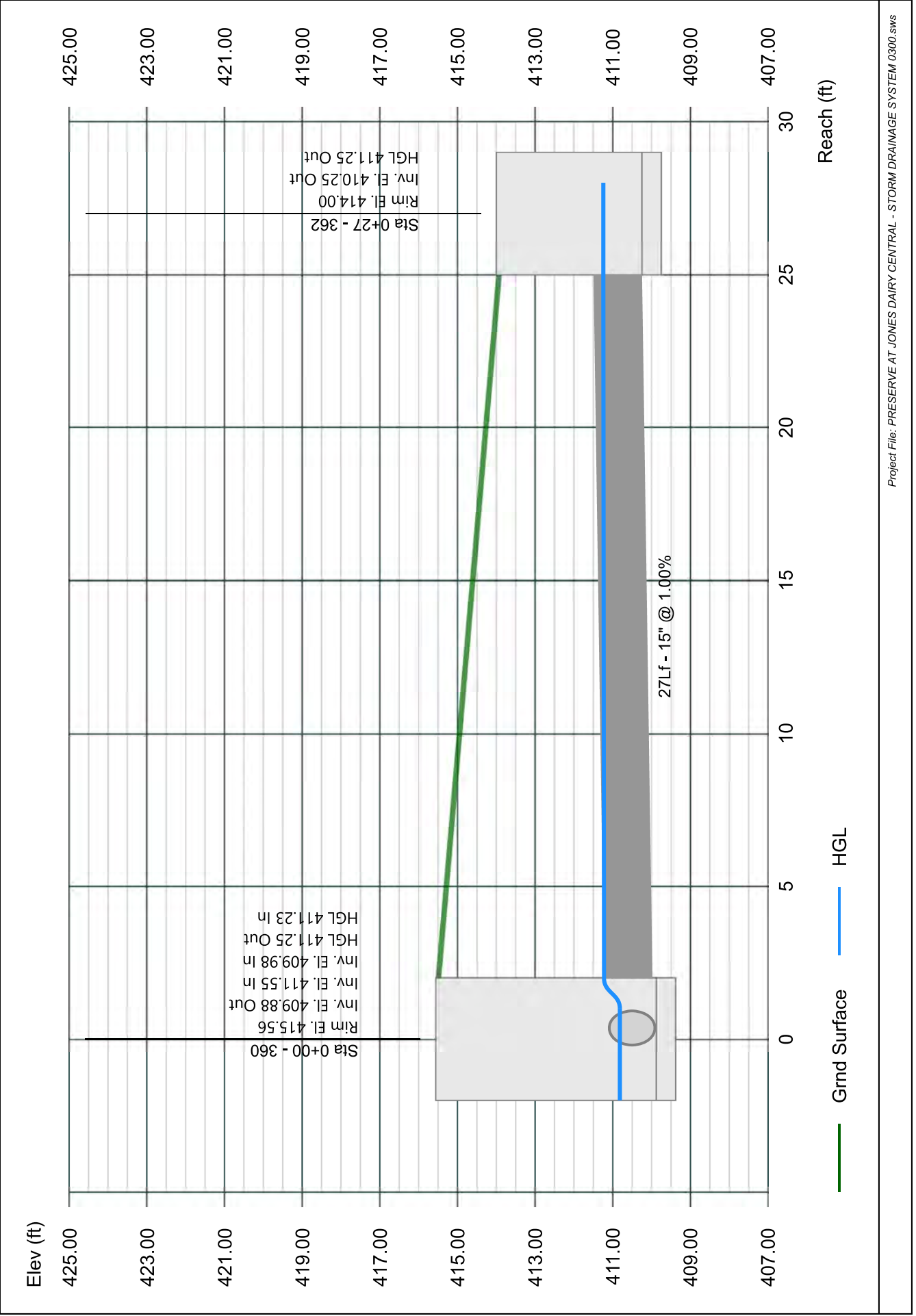

Line 23 - 356 TO 305

Stormwater Studio 2023 v 3.0.0.31

Project Name: Enter Project Name...

05-03-2023

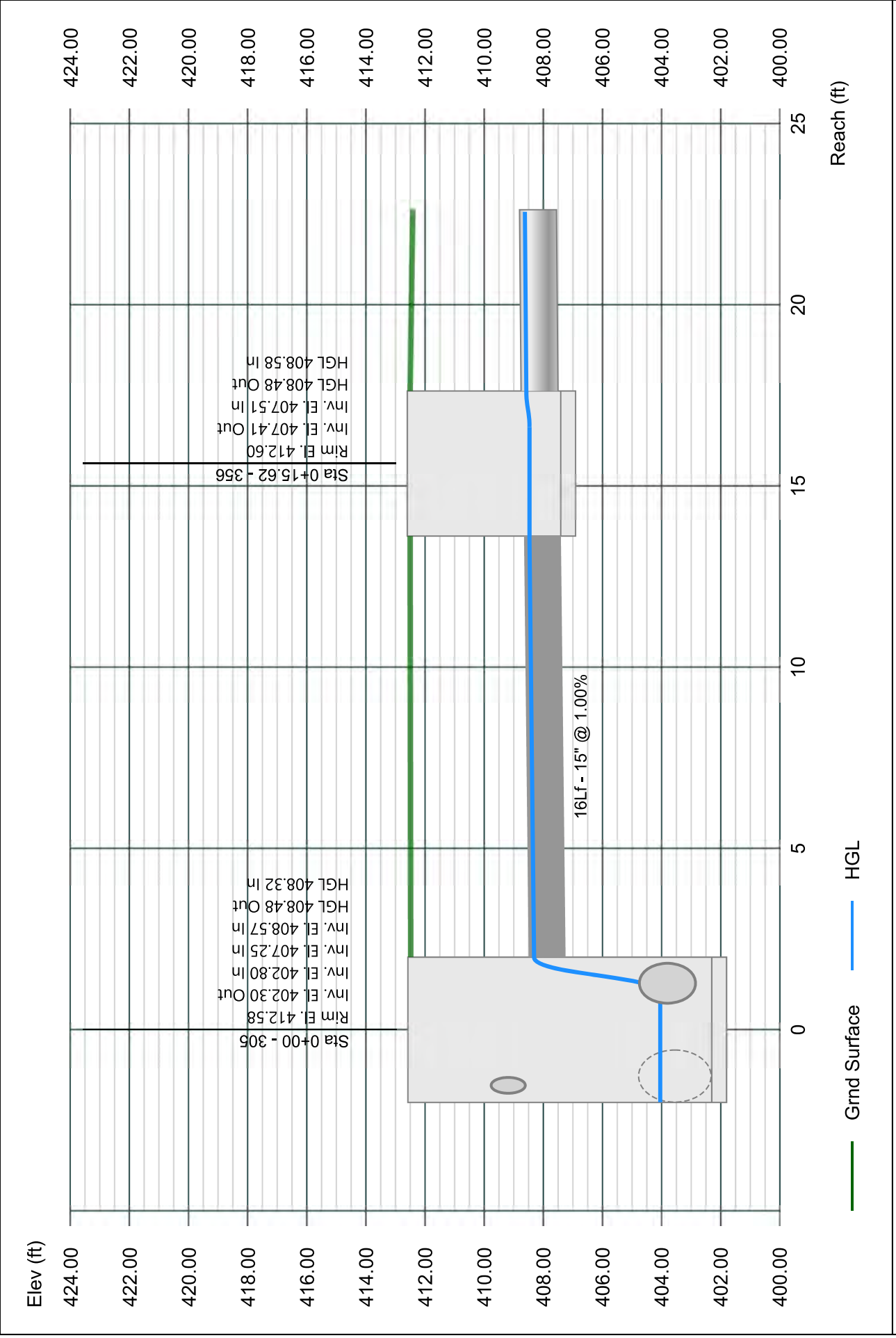

Line 24 - 357 TO 356

Stormwater Studio 2023 v 3.0.0.31

Project Name: Enter Project Name...

05-03-2023

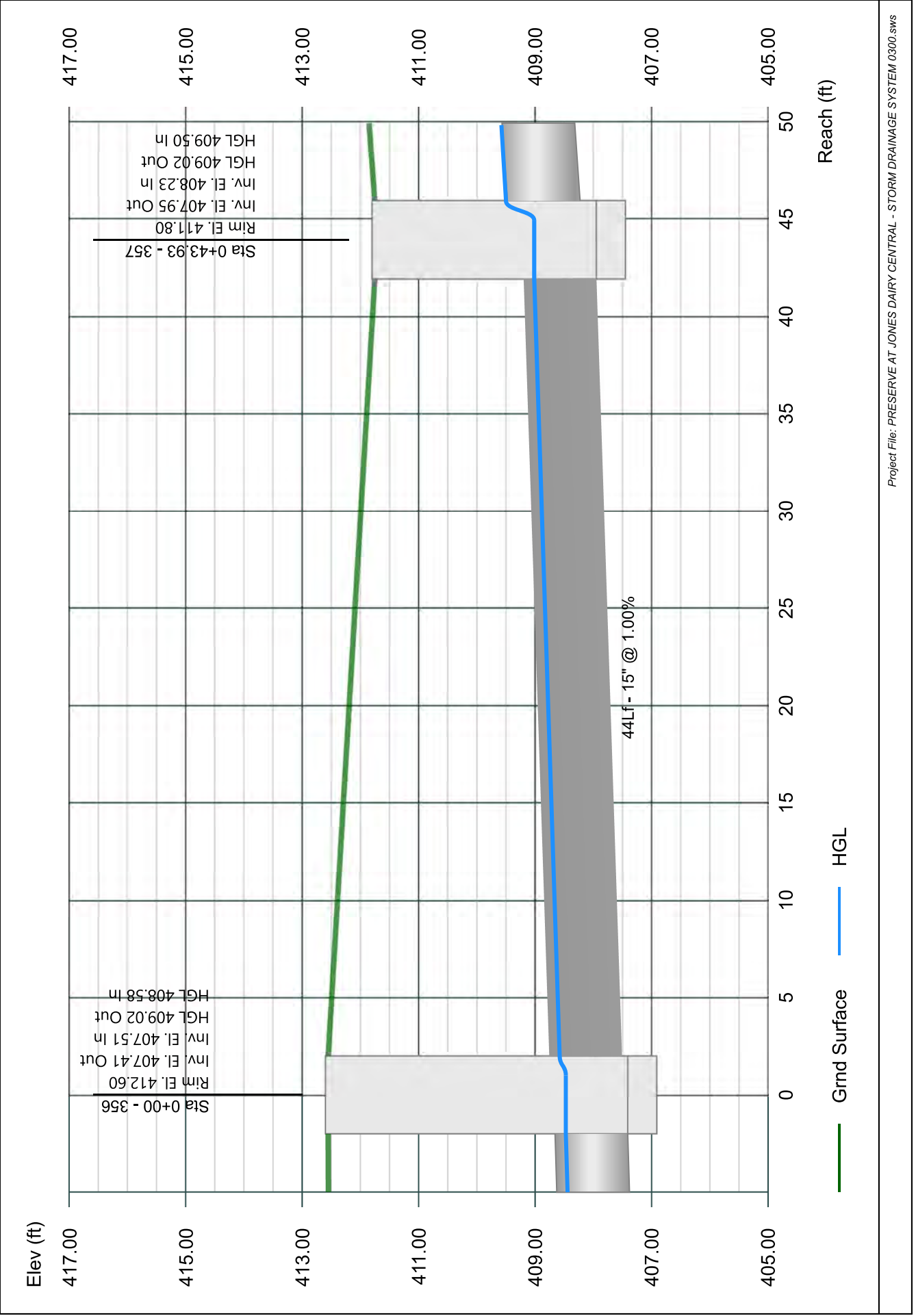

Line 25 - 358 TO 357

Stormwater Studio 2023 v 3.0.0.31

Project Name: Enter Project Name...

05-03-2023

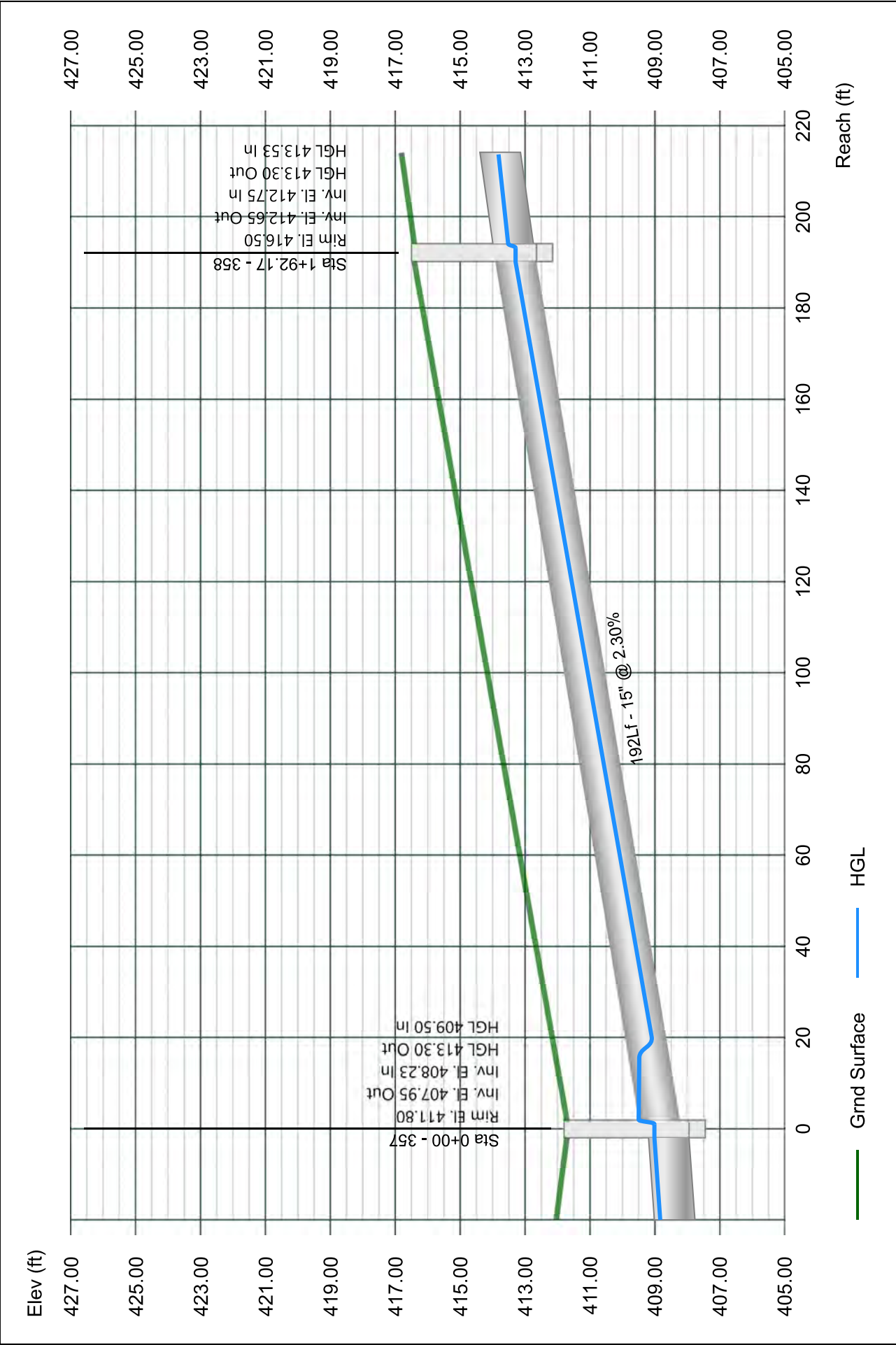

Line 26 - 359 TO 358

Stormwater Studio 2023 v 3.0.0.31

Project Name: Enter Project Name...

05-03-2023

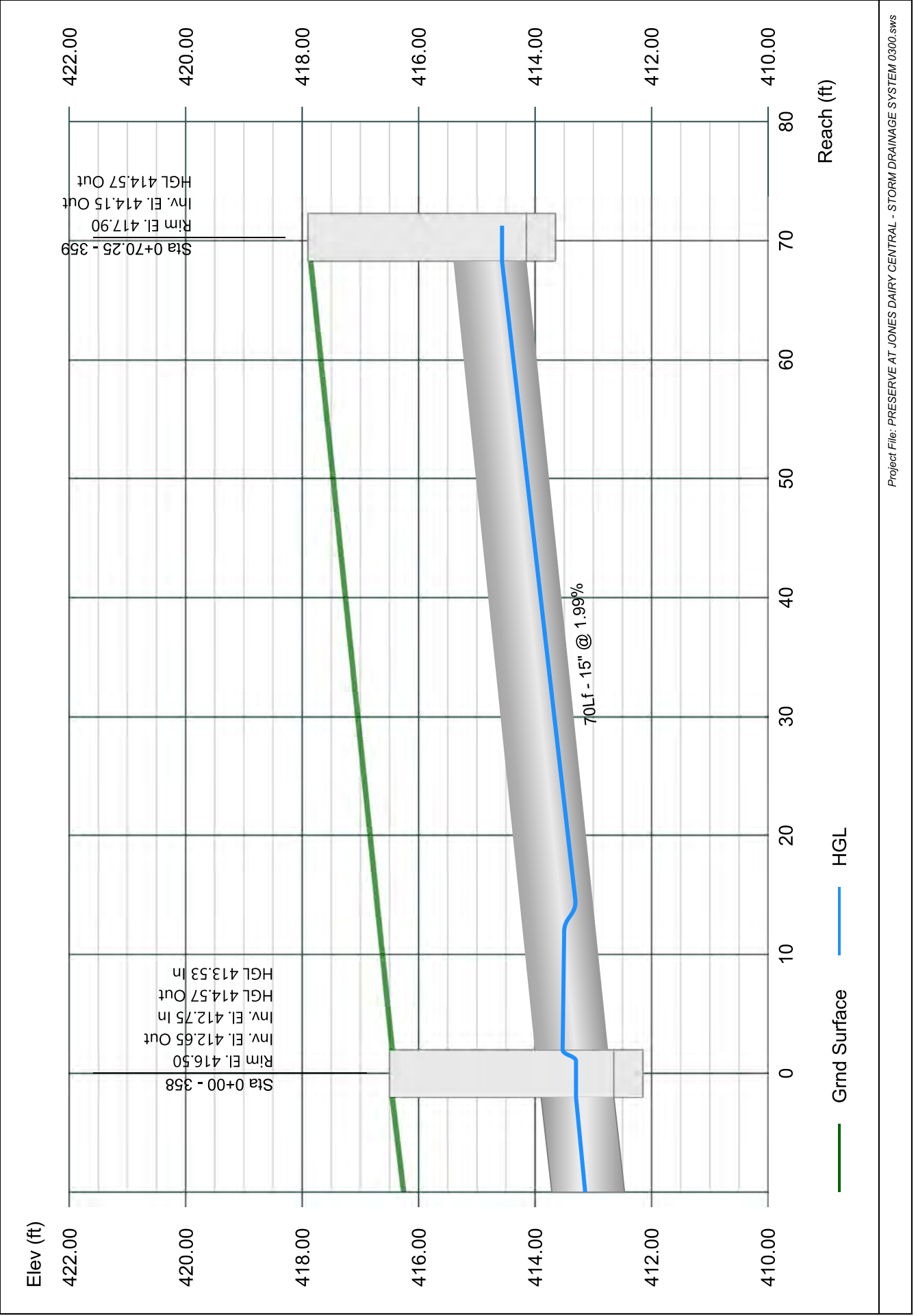

Line 27 - 355 TO 305

Stormwater Studio 2023 v 3.0.0.31

Project Name: Enter Project Name...

05-03-2023

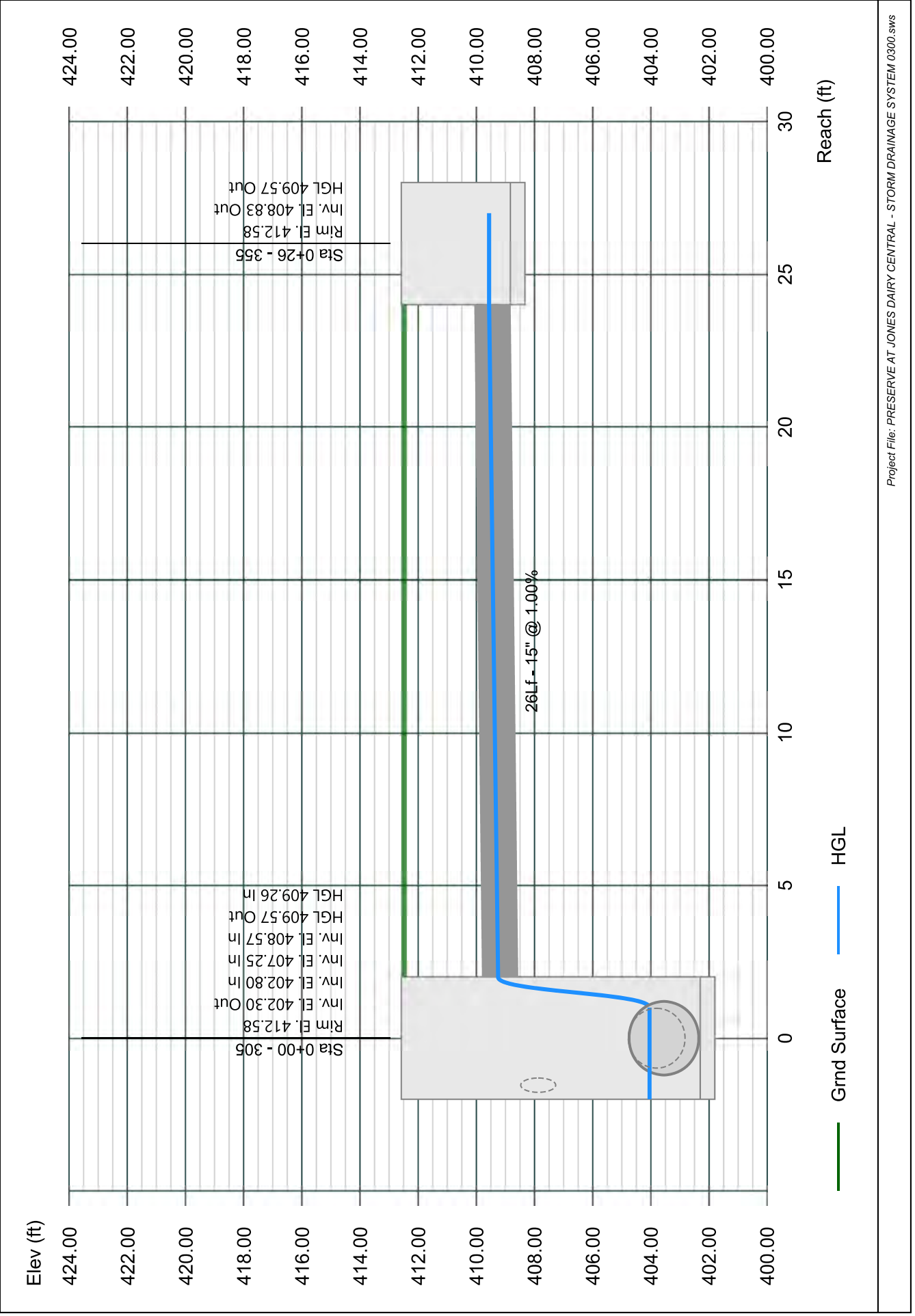

Line 28 - 338 TO 304

Project Name: Enter Project Name...

Stormwater Studio 2023 v 3.0.0.31

05-03-2023

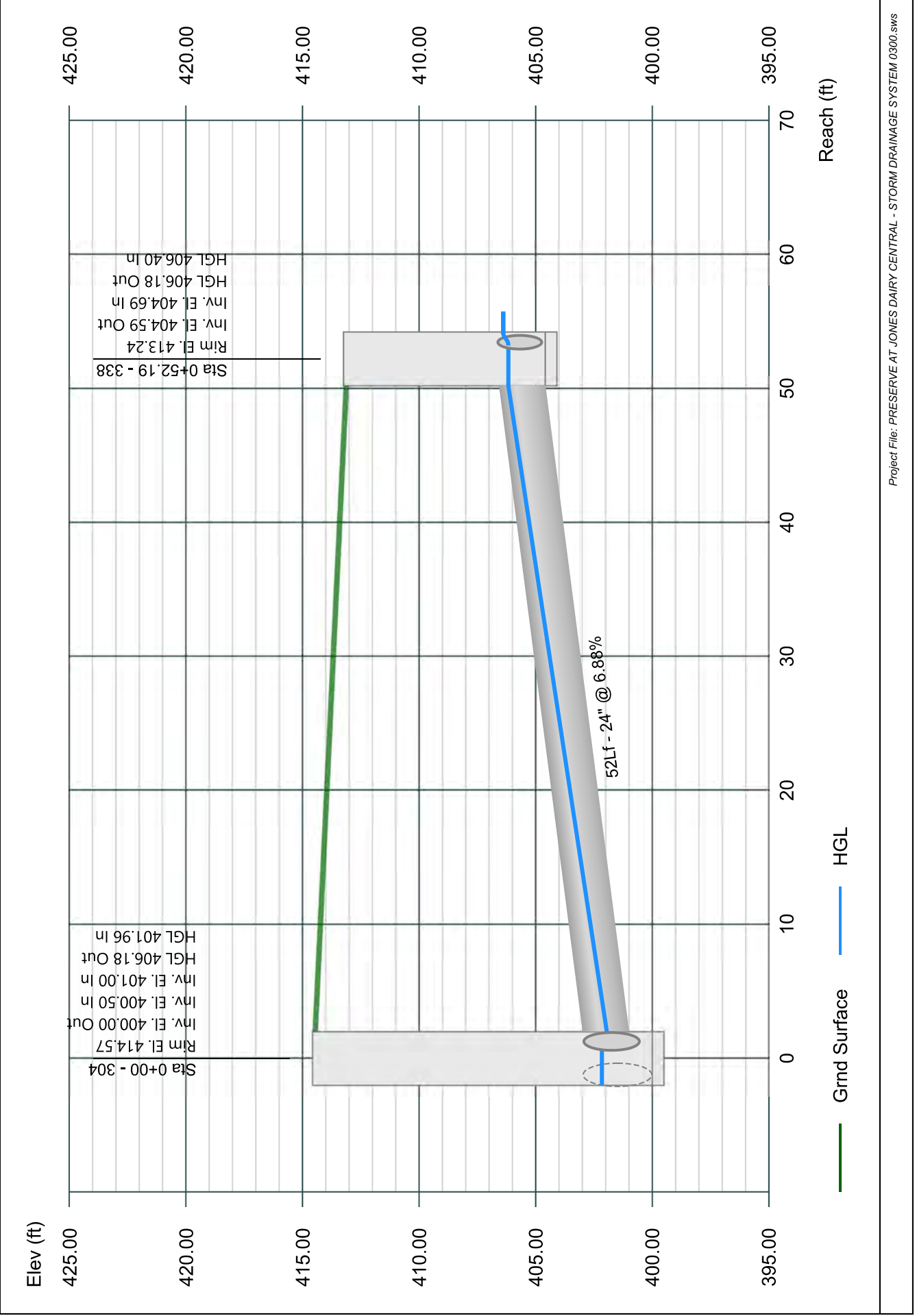

Line 29 - 339 TO 338

Stormwater Studio 2023 v 3.0.0.31

Project Name: Enter Project Name...

05-03-2023

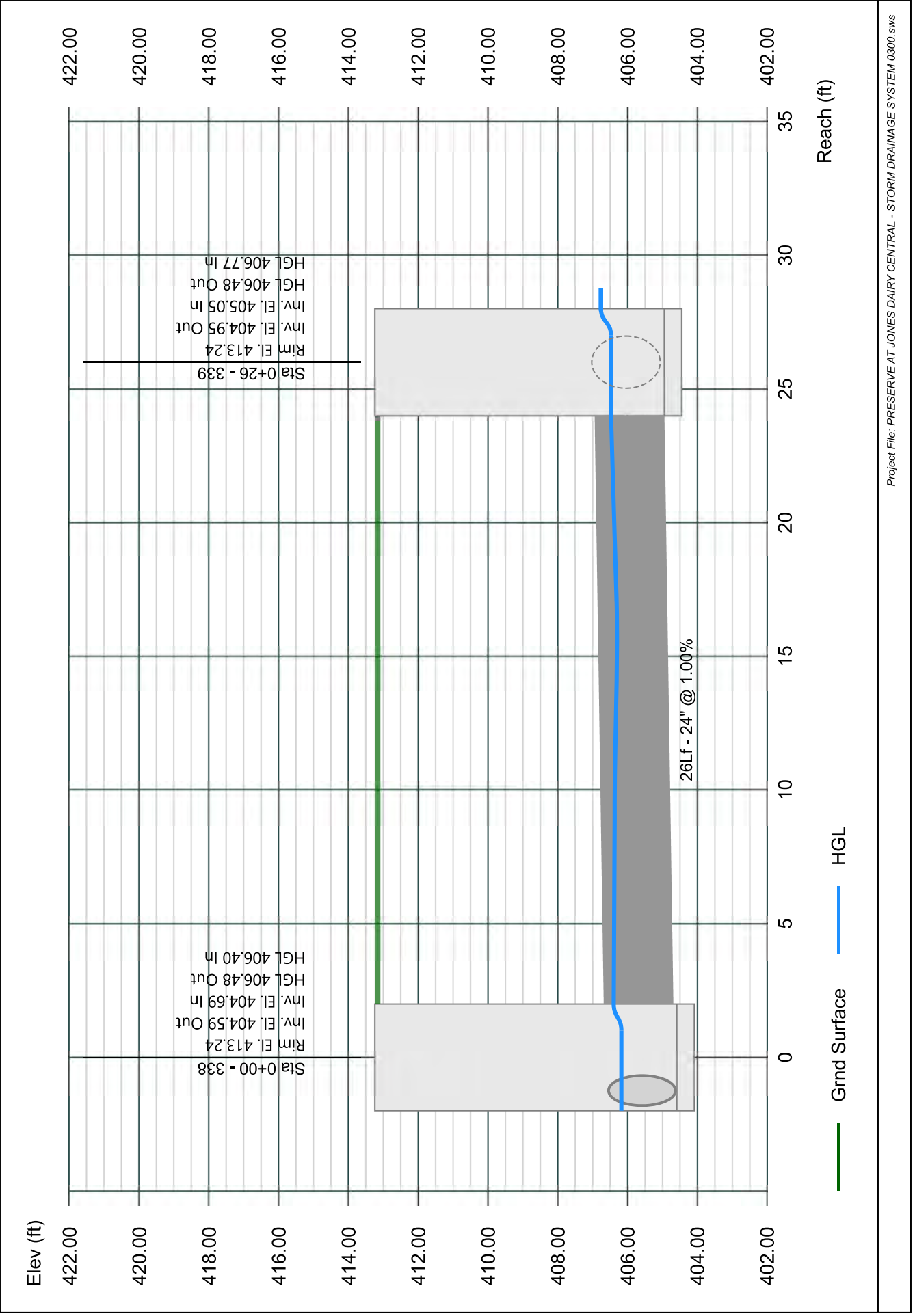

Line 30 - 340 TO 339

Stormwater Studio 2023 v 3.0.0.31

Project Name: Enter Project Name...

05-03-2023

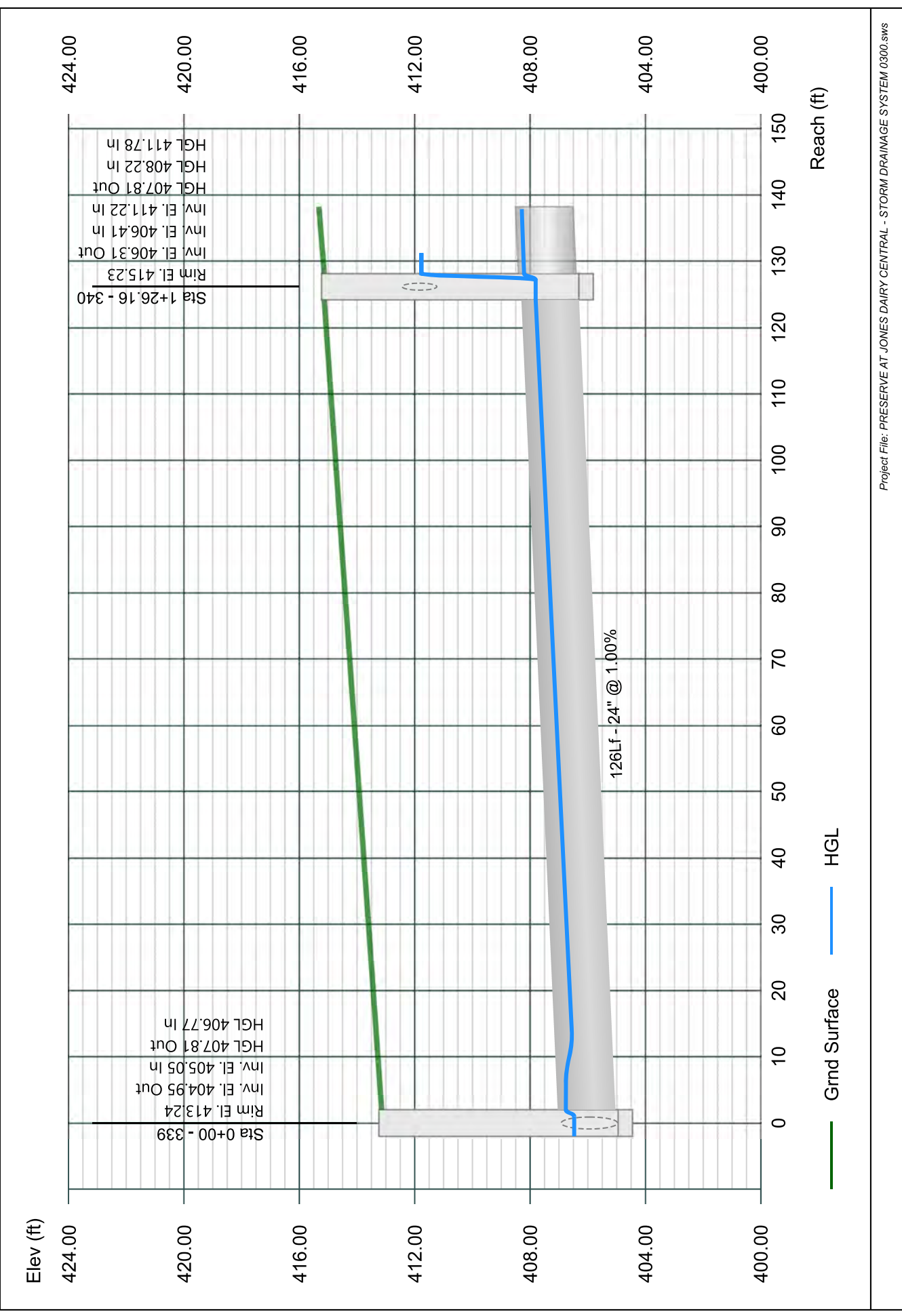

Line 31 - 341 TO 340

Stormwater Studio 2023 v 3.0.0.31

Project Name: Enter Project Name...

05-03-2023

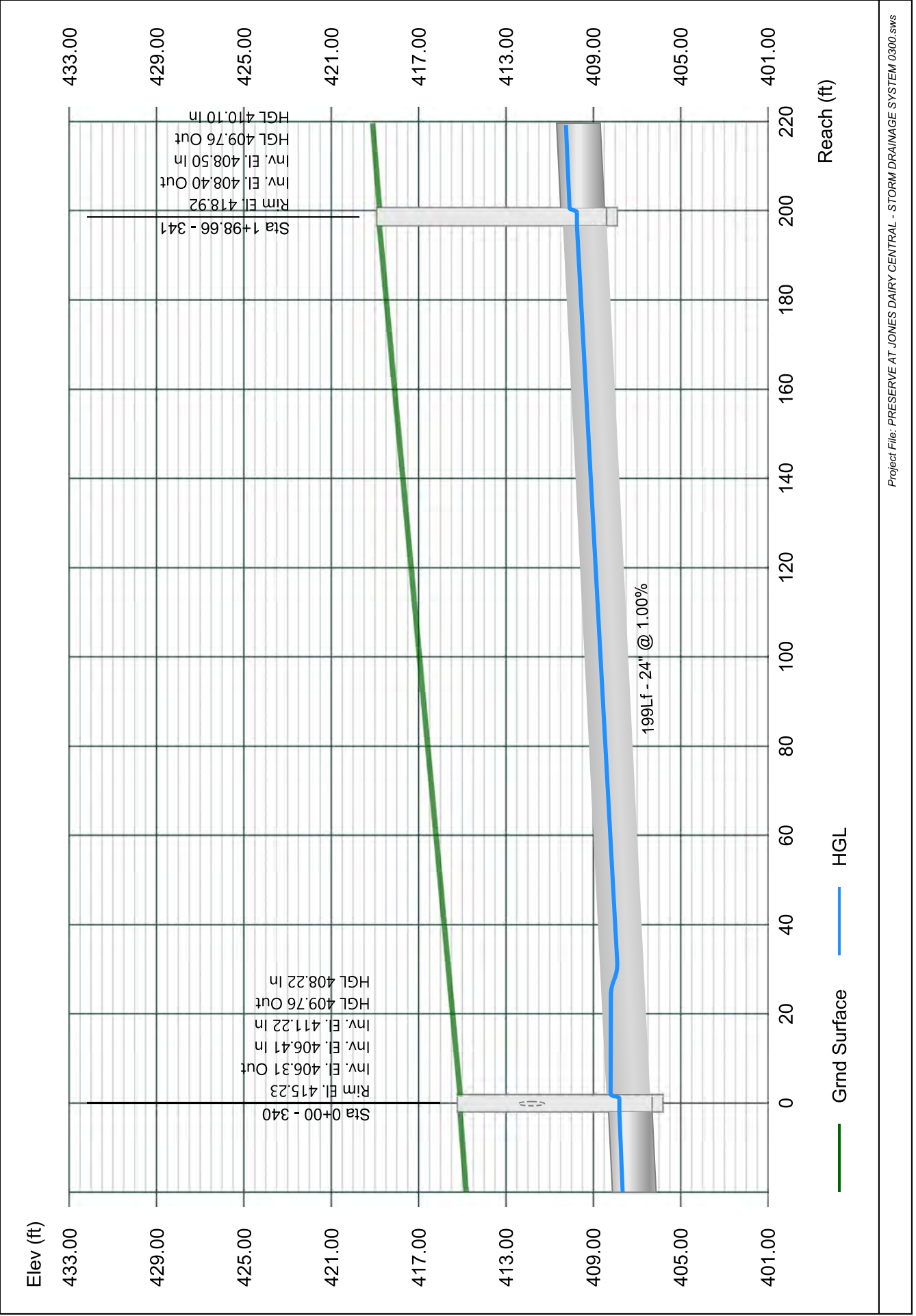

Line 32 - 342 TO 341

Stormwater Studio 2023 v 3.0.0.31

Project Name: Enter Project Name...

05-03-2023

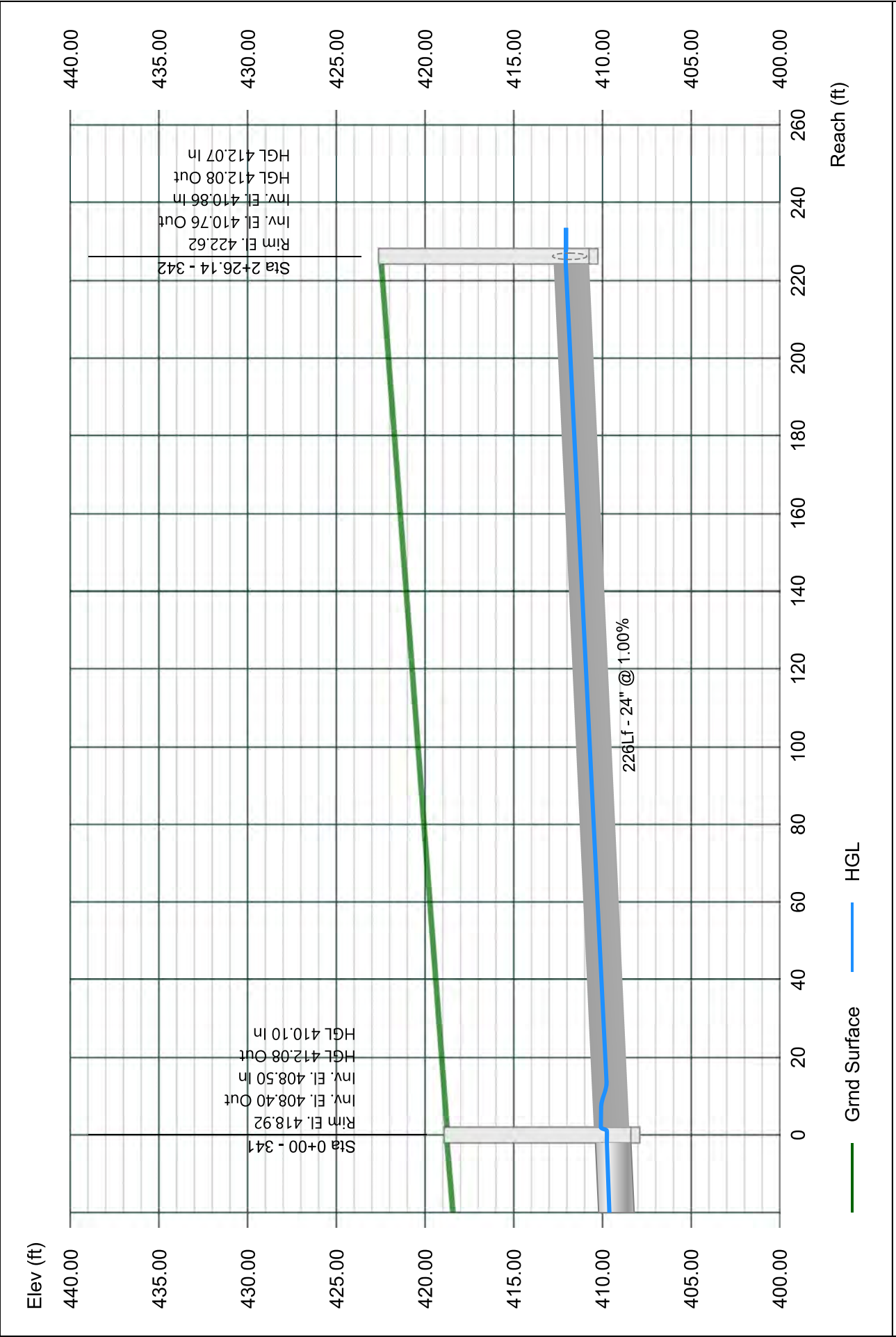

Line 33 - 343 TO 342

Stormwater Studio 2023 v 3.0.0.31

Project Name: Enter Project Name...

05-03-2023

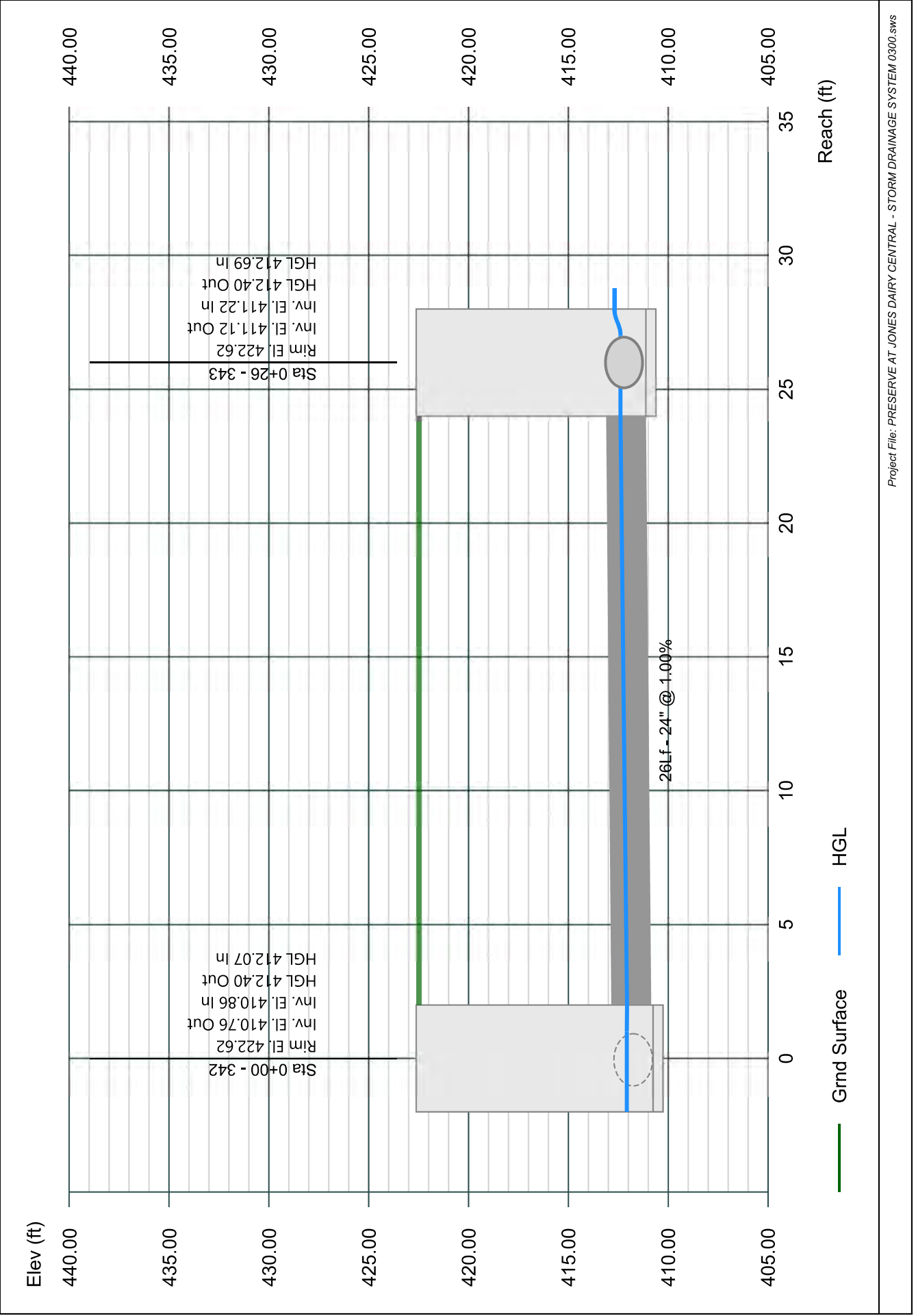

Line 34 - 343A TO 343

Stormwater Studio 2023 v 3.0.0.31

Project Name: Enter Project Name...

05-03-2023

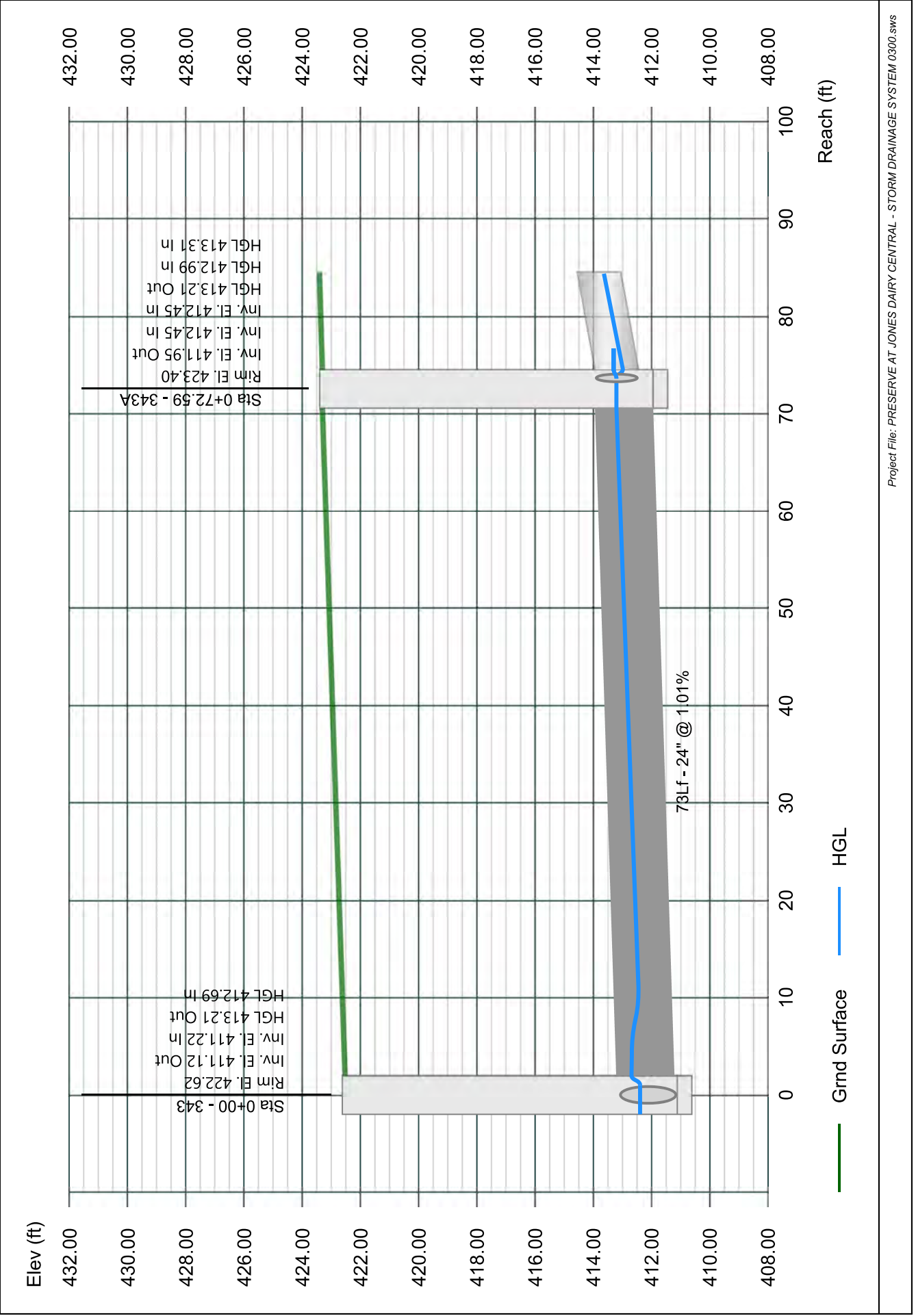

Line 35 - 344 TO 343

Stormwater Studio 2023 v 3.0.0.31

Project Name: Enter Project Name...

05-03-2023

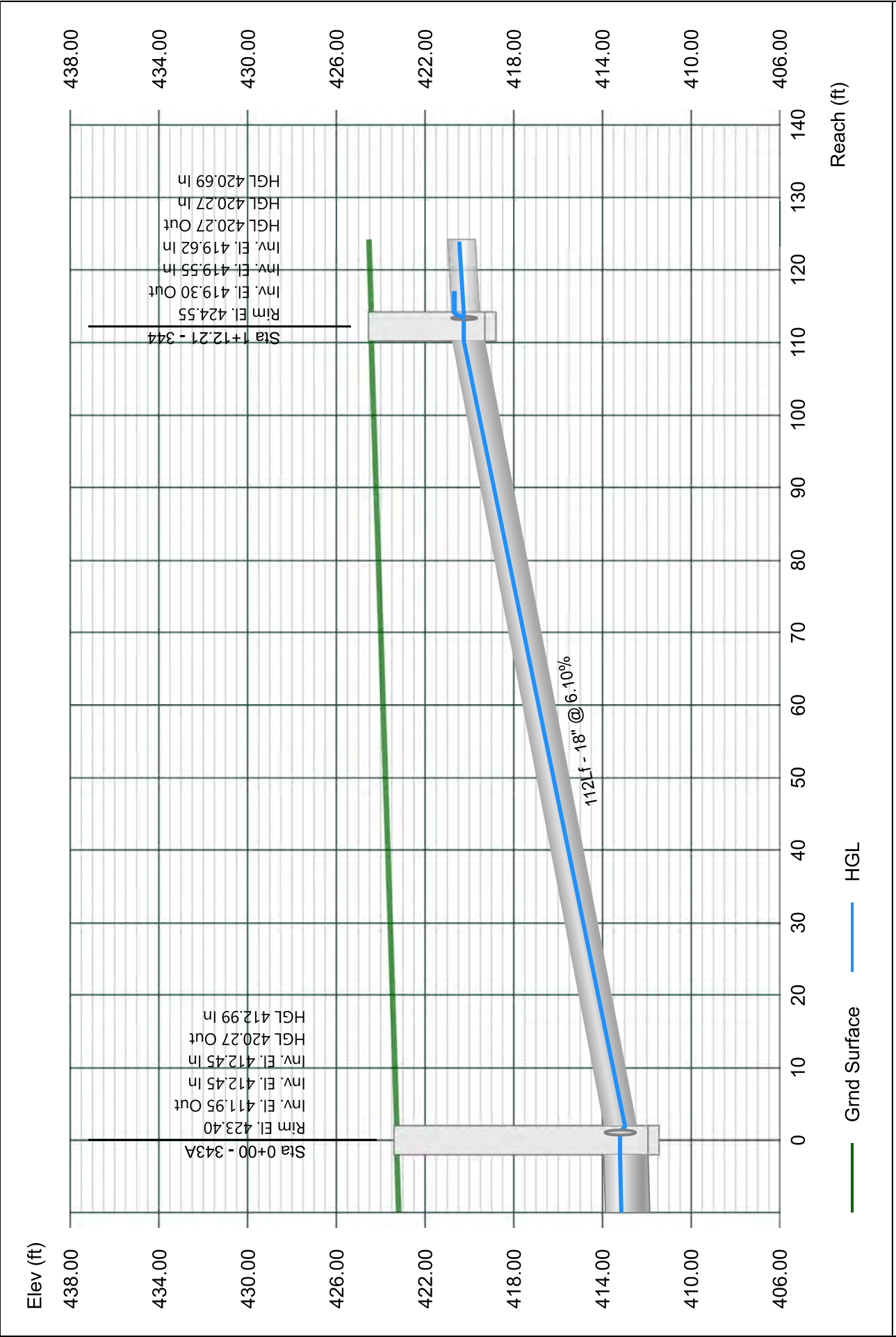

Line 36 - 345 TO 344

Stormwater Studio 2023 v 3.0.0.31

Project Name: Enter Project Name...

05-03-2023

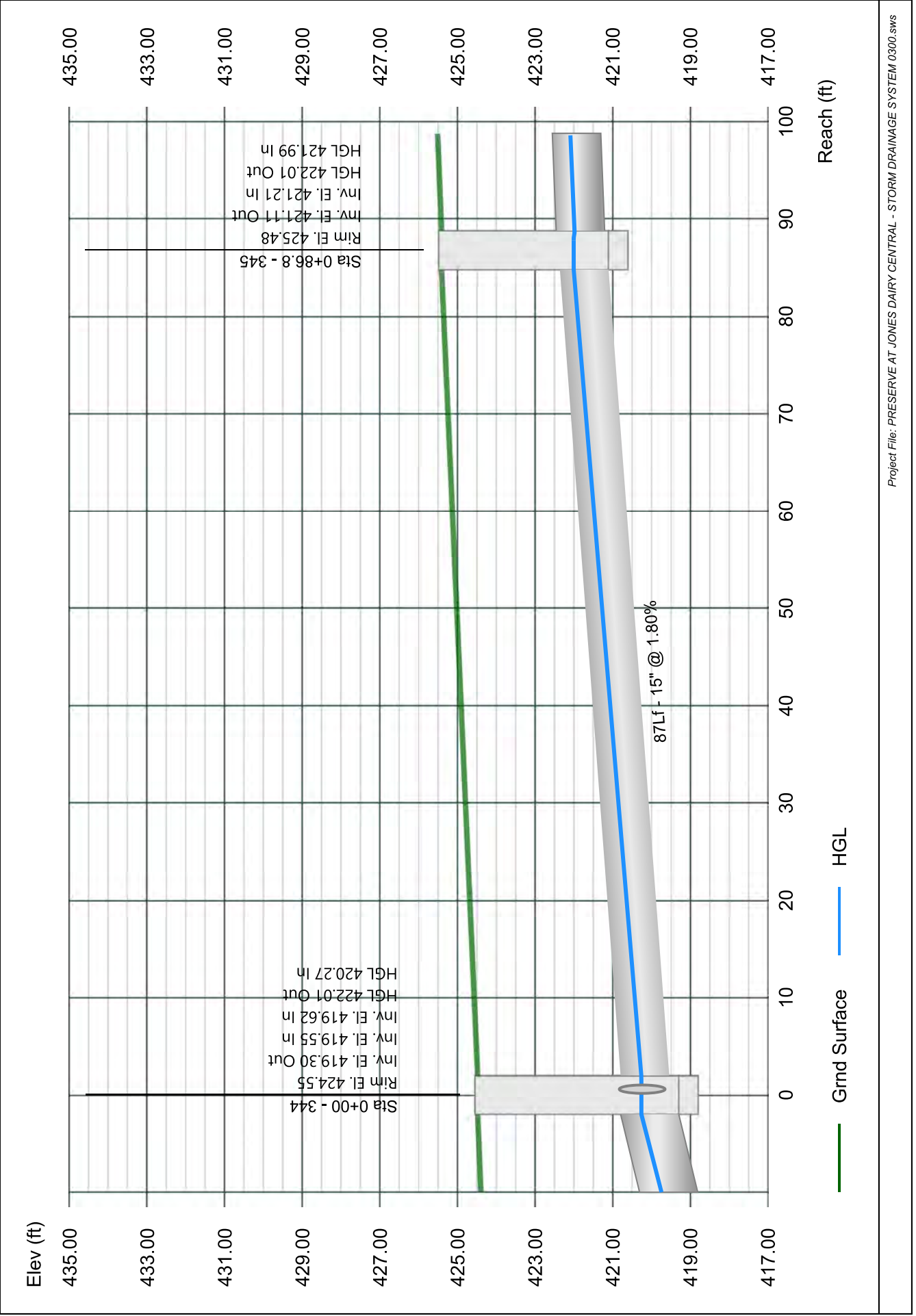

Line 37 - 346 TO 345

Stormwater Studio 2023 v 3.0.0.31

Project Name: Enter Project Name...

05-03-2023

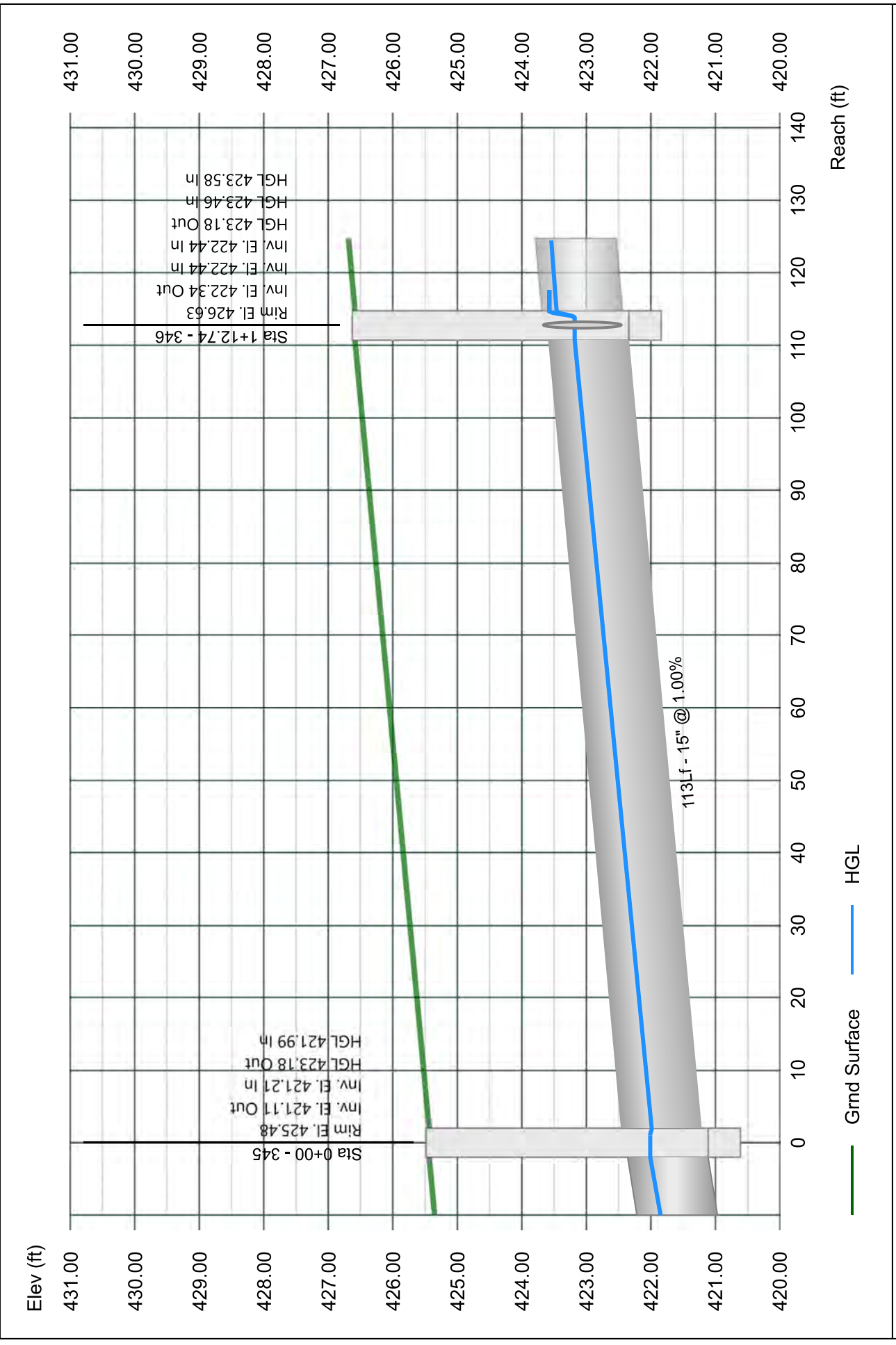

Line 38 - 347 TO 346

Stormwater Studio 2023 v 3.0.0.31

Project Name: Enter Project Name...

05-03-2023

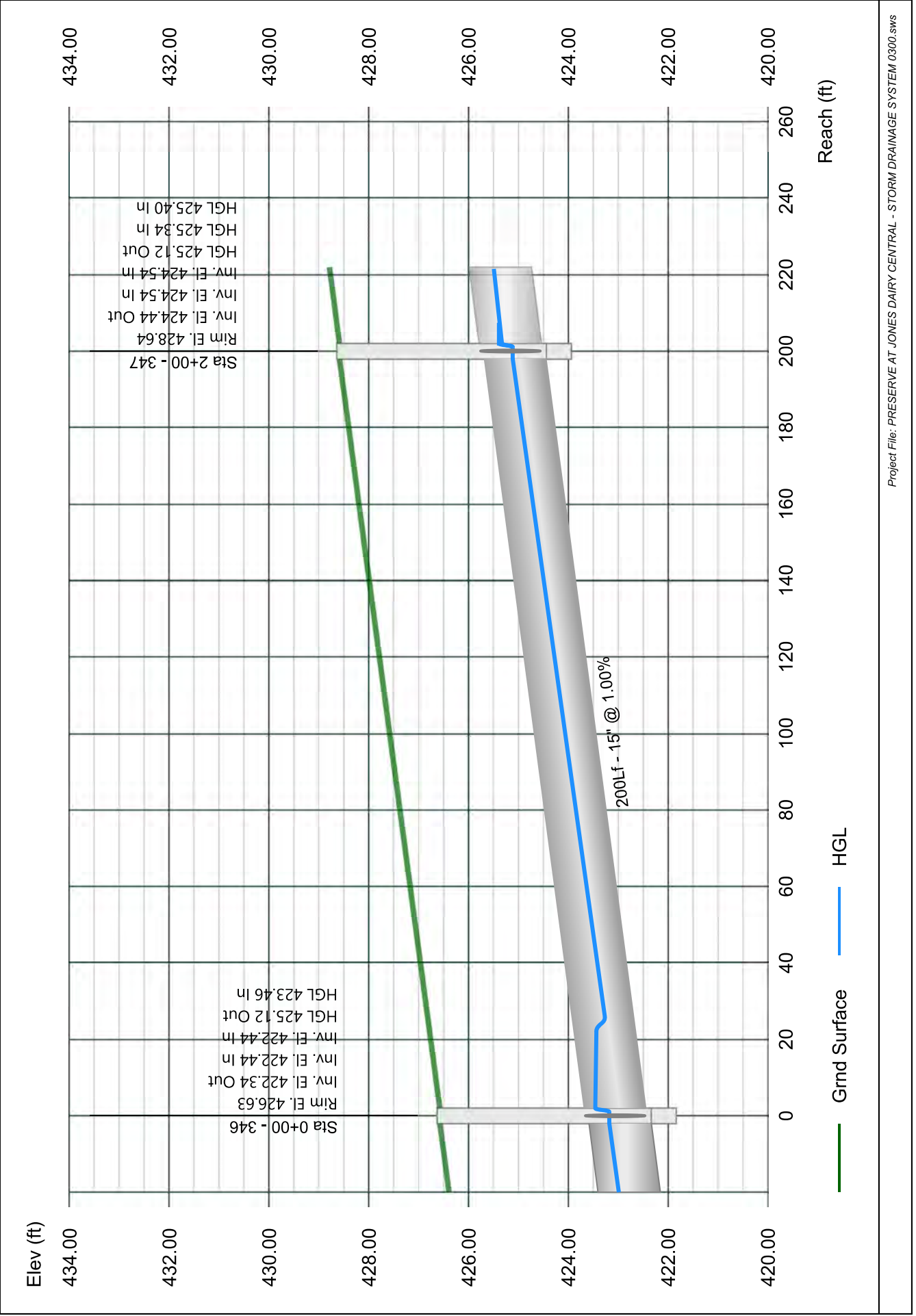

Line 39 - 348 TO 347

Stormwater Studio 2023 v 3.0.0.31

Project Name: Enter Project Name...

05-03-2023

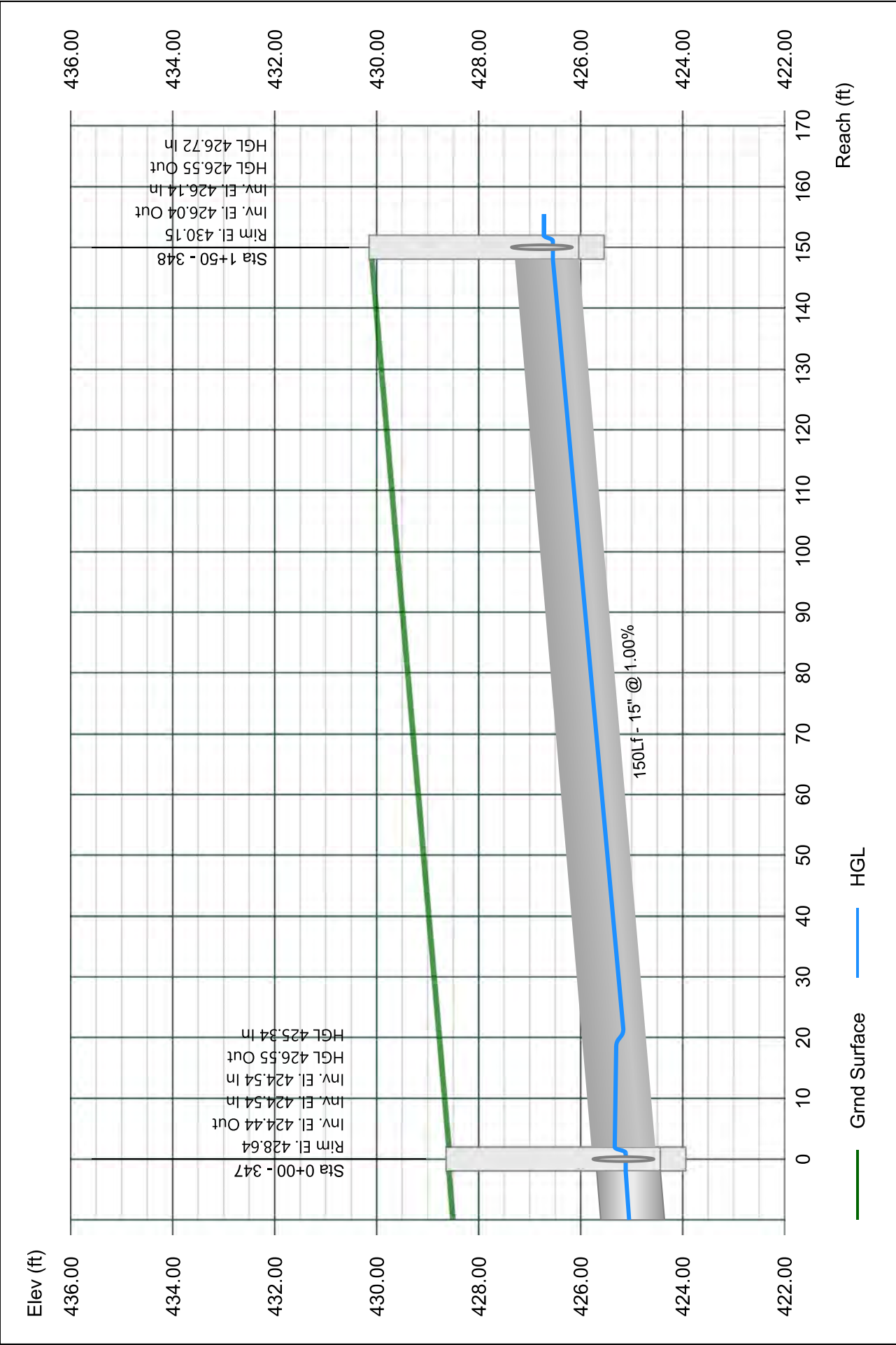

Line 40 - 348 TO 349

Stormwater Studio 2023 v 3.0.0.31

Project Name: Enter Project Name...

05-03-2023

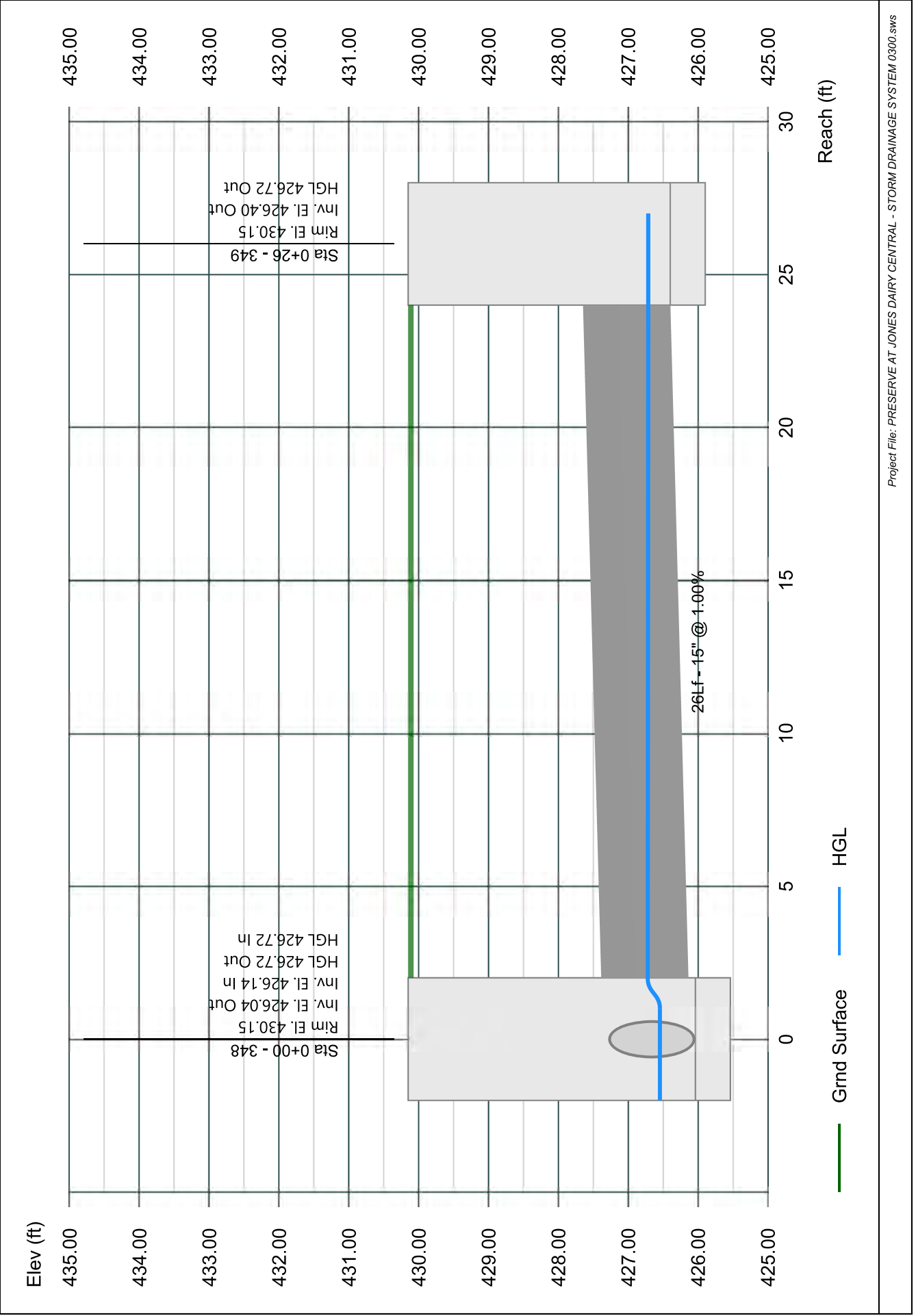

Line 41 - 354 TO 347

Stormwater Studio 2023 v 3.0.0.31

Project Name: Enter Project Name...

05-03-2023

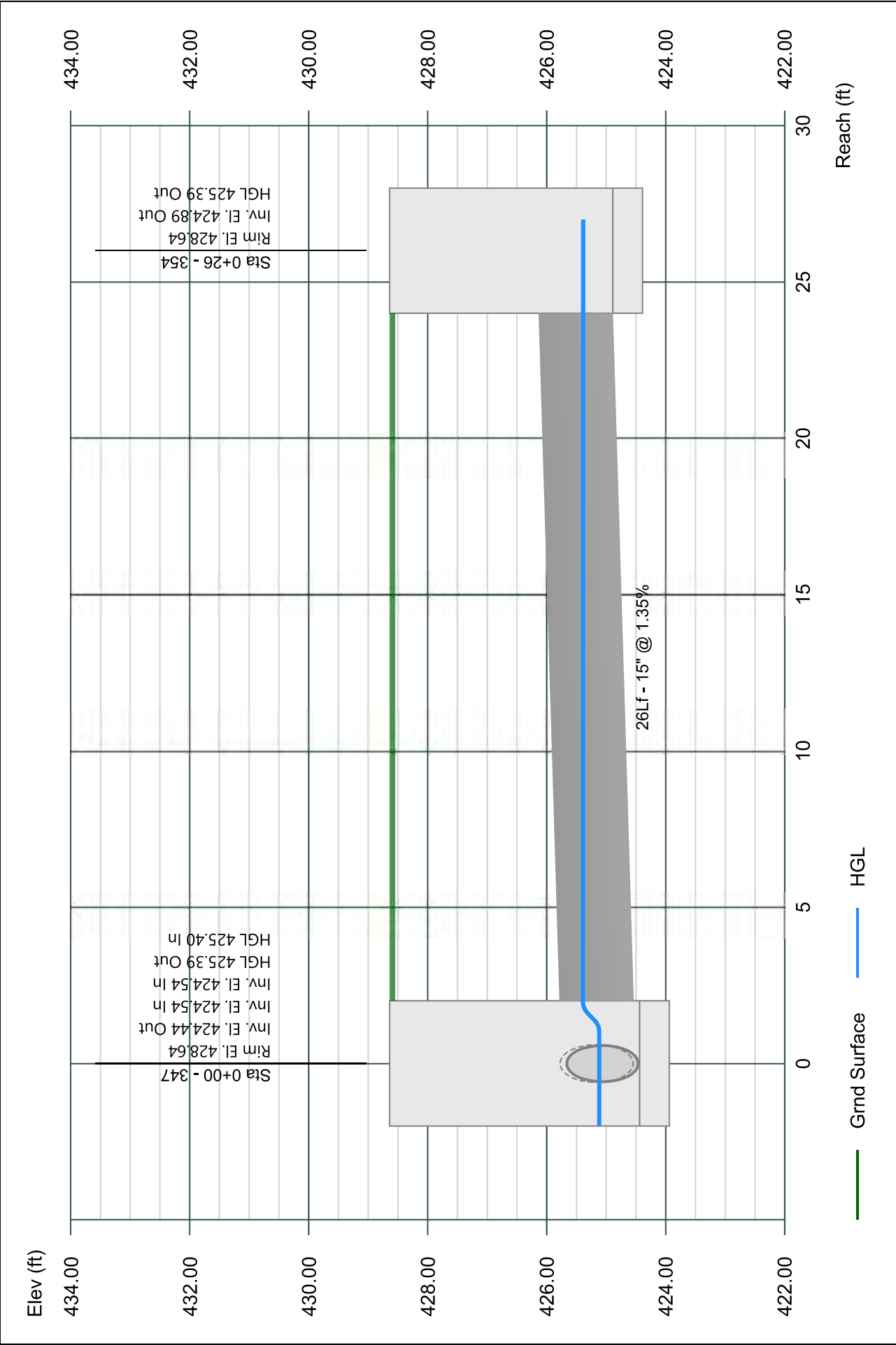

Line 42 - 353 TO 346

Stormwater Studio 2023 v 3.0.0.31

Project Name: Enter Project Name...

05-03-2023

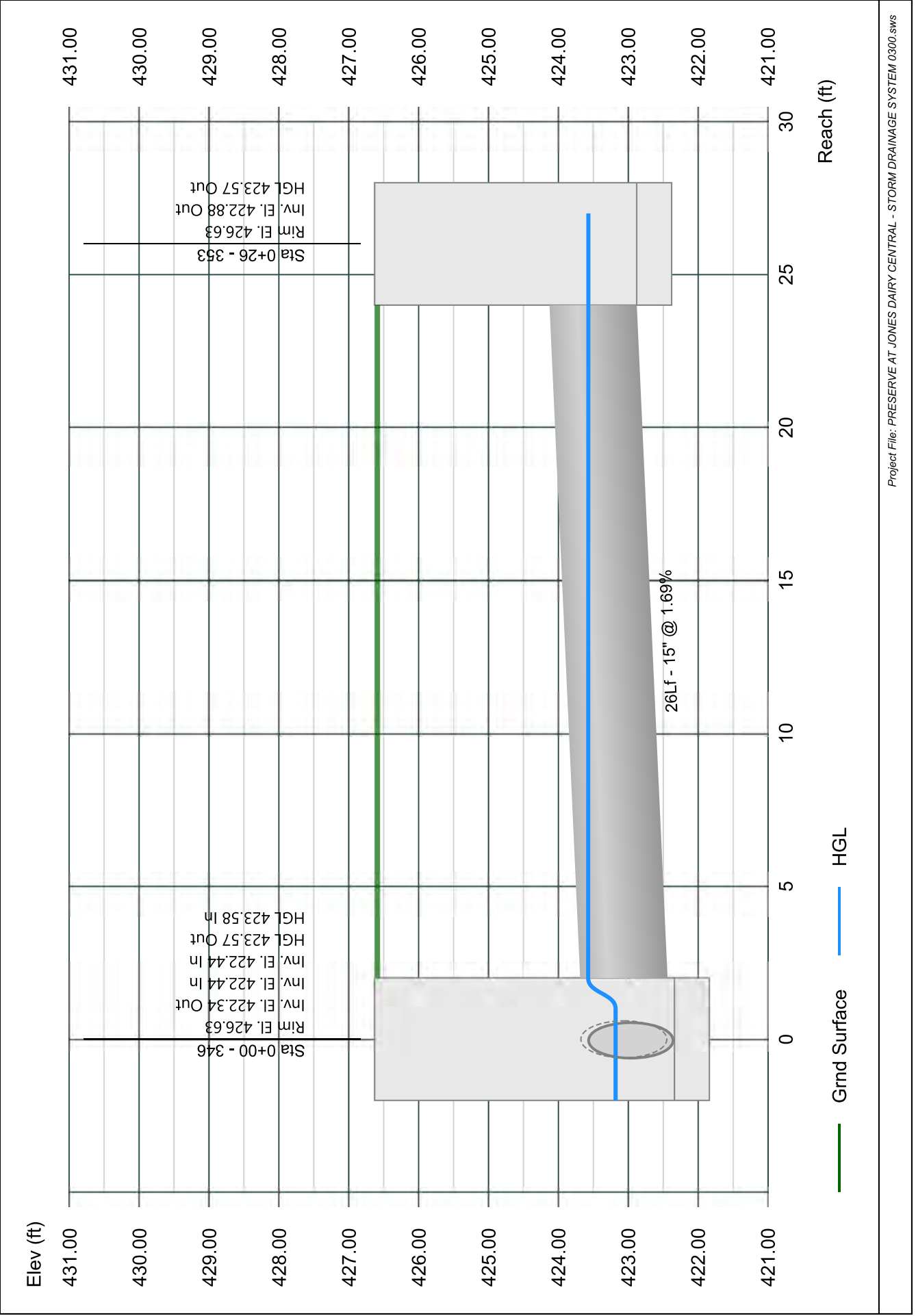

Line 43 - 351 TO 344

Stormwater Studio 2023 v 3.0.0.31

Project Name: Enter Project Name...

05-03-2023

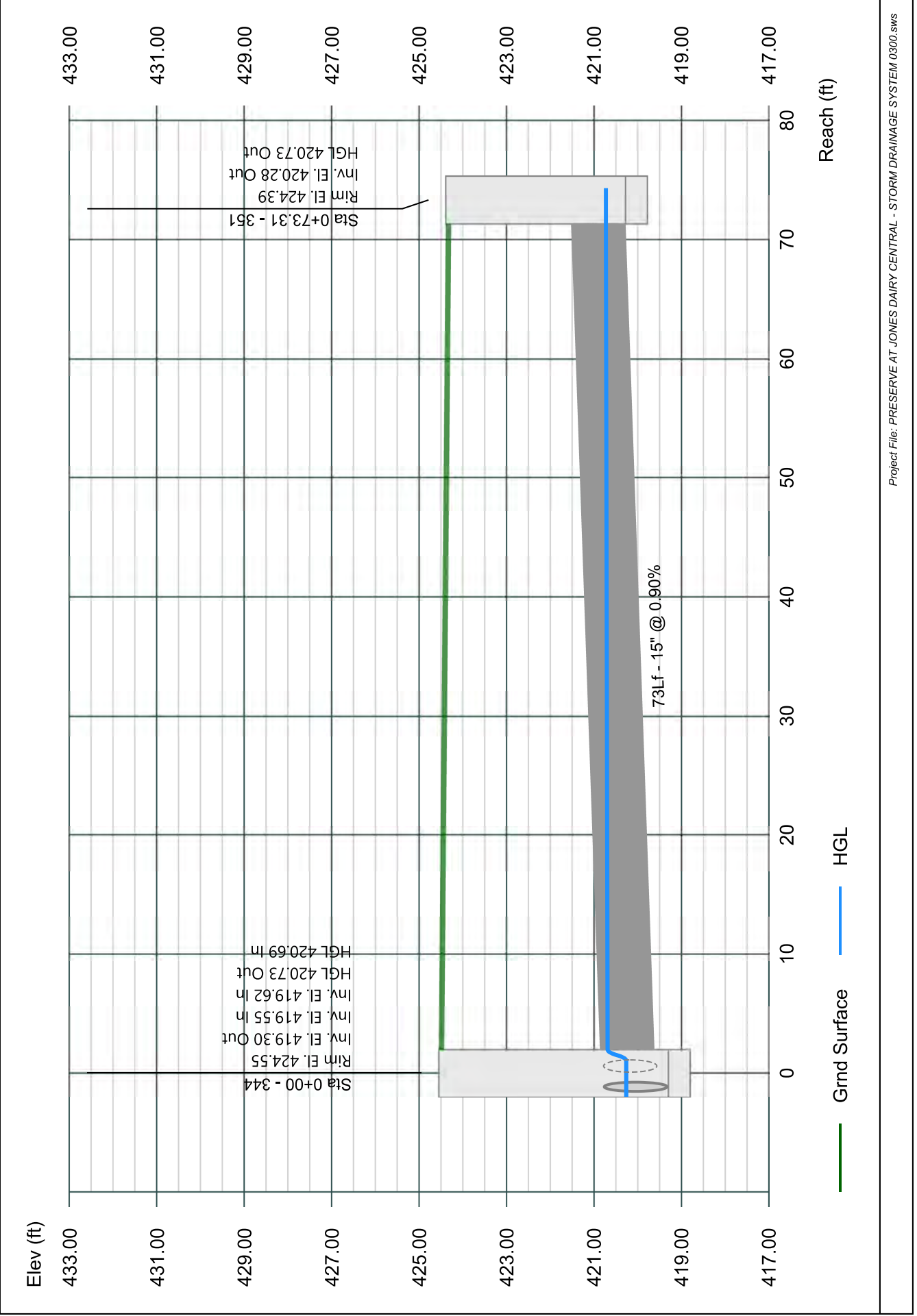

Line 44 - 315 TO 343A

Stormwater Studio 2023 v 3.0.0.31

Project Name: Enter Project Name...

05-03-2023

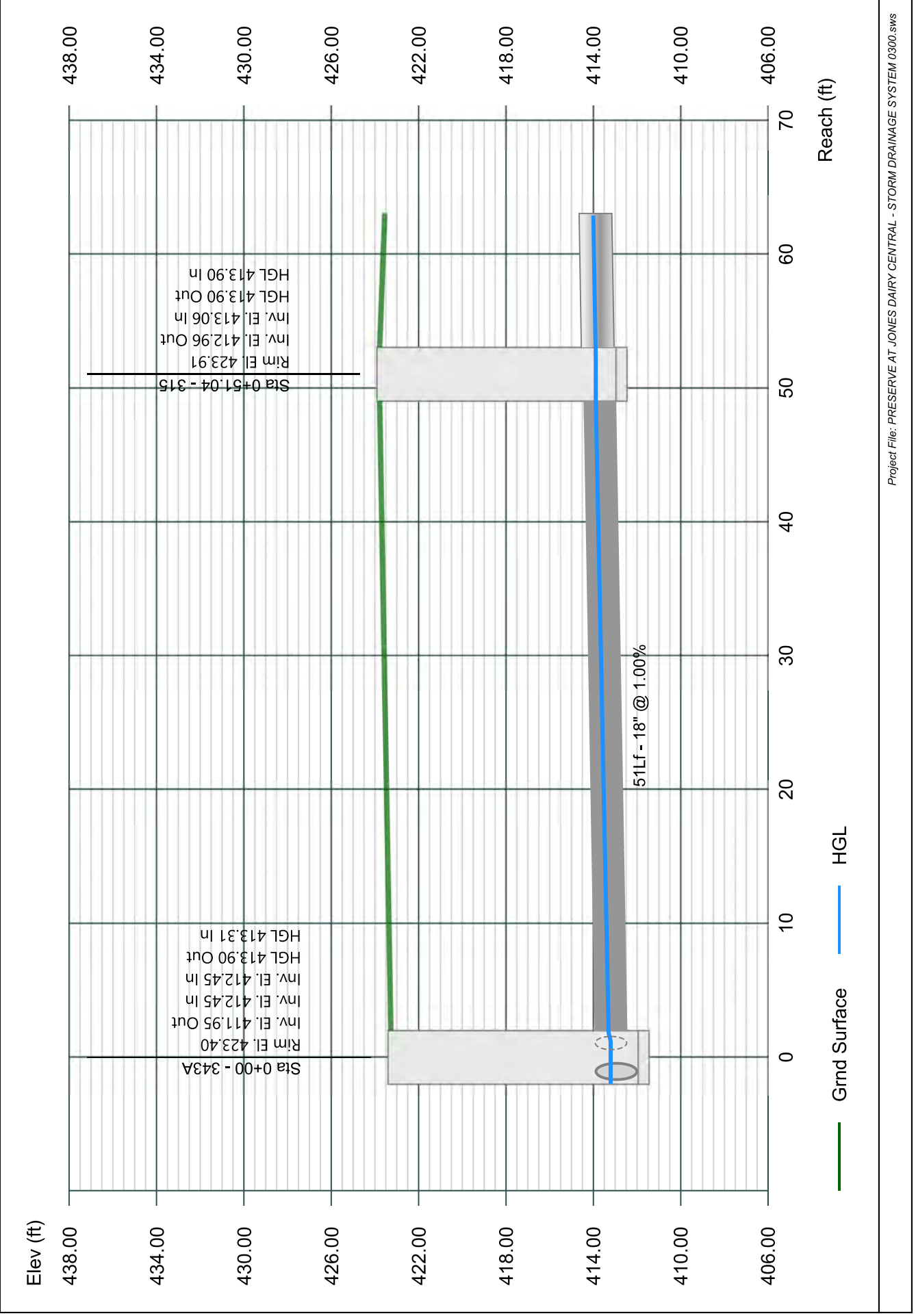

Line 45 - 316 TO 315

Stormwater Studio 2023 v 3.0.0.31

Project Name: Enter Project Name...

05-03-2023

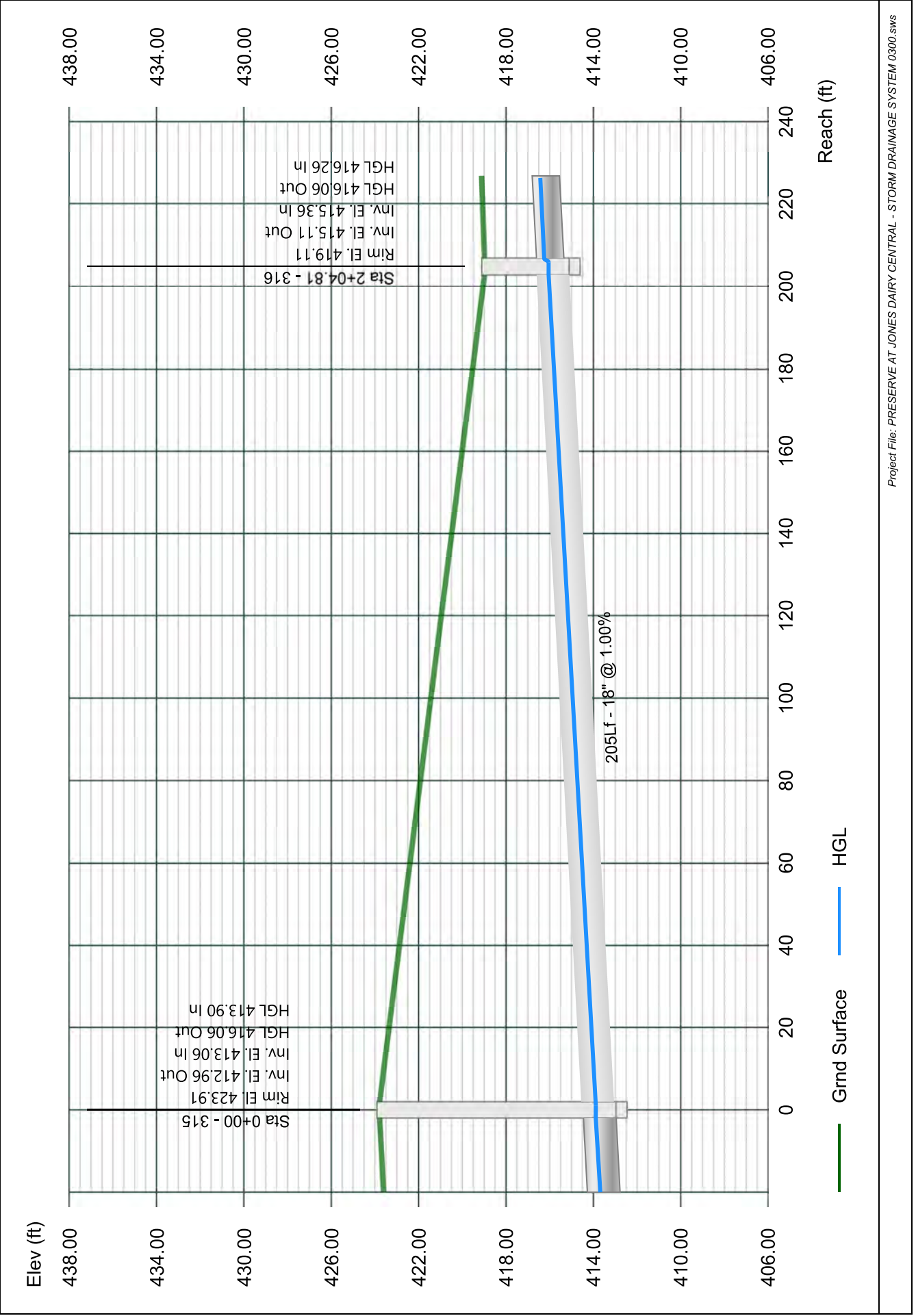

Line 46 - 317 TO 316

Stormwater Studio 2023 v 3.0.0.31

Project Name: Enter Project Name...

05-03-2023

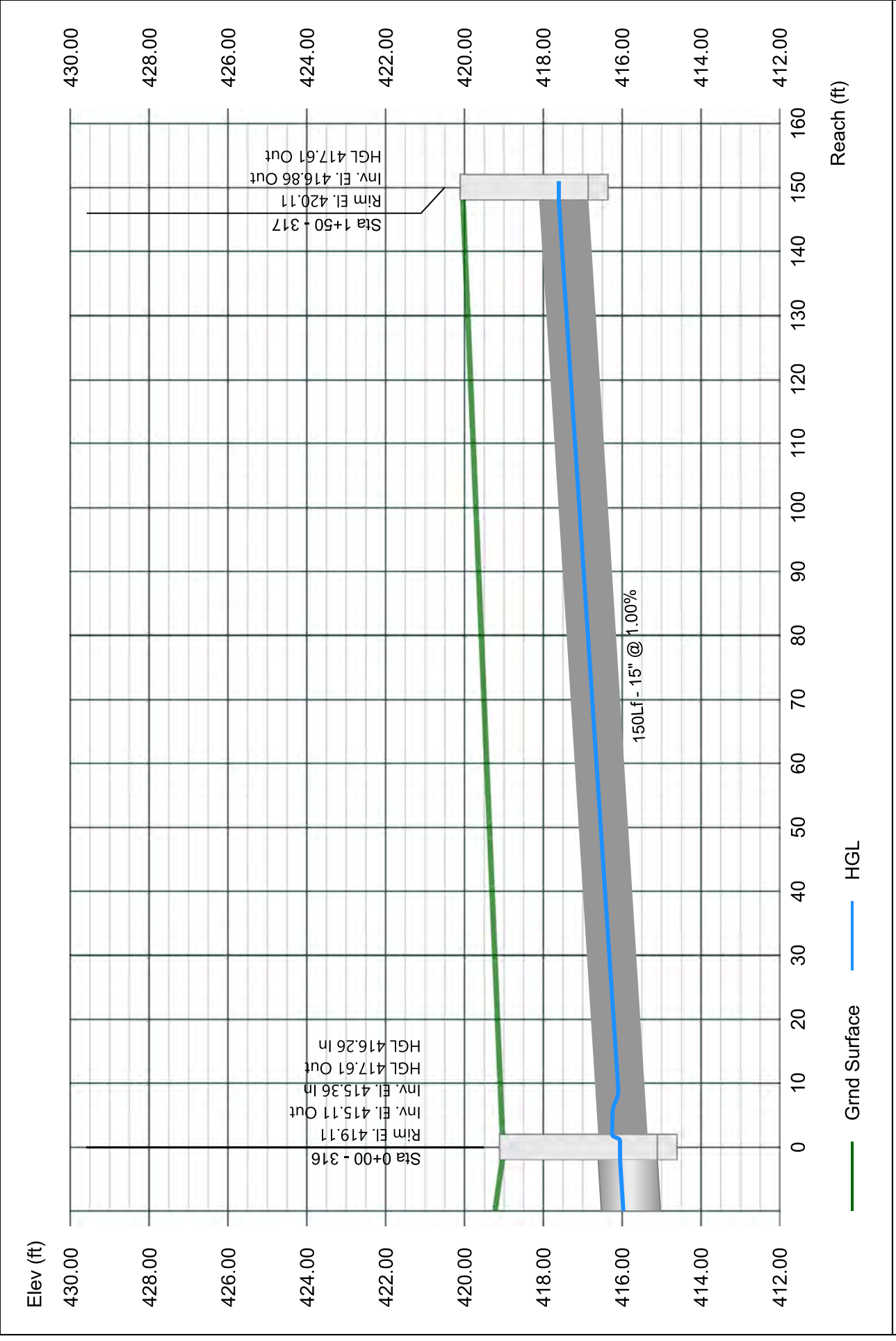

Line 47 - 350 TO 340

Stormwater Studio 2023 v 3.0.0.31

Project Name: Enter Project Name...

05-03-2023

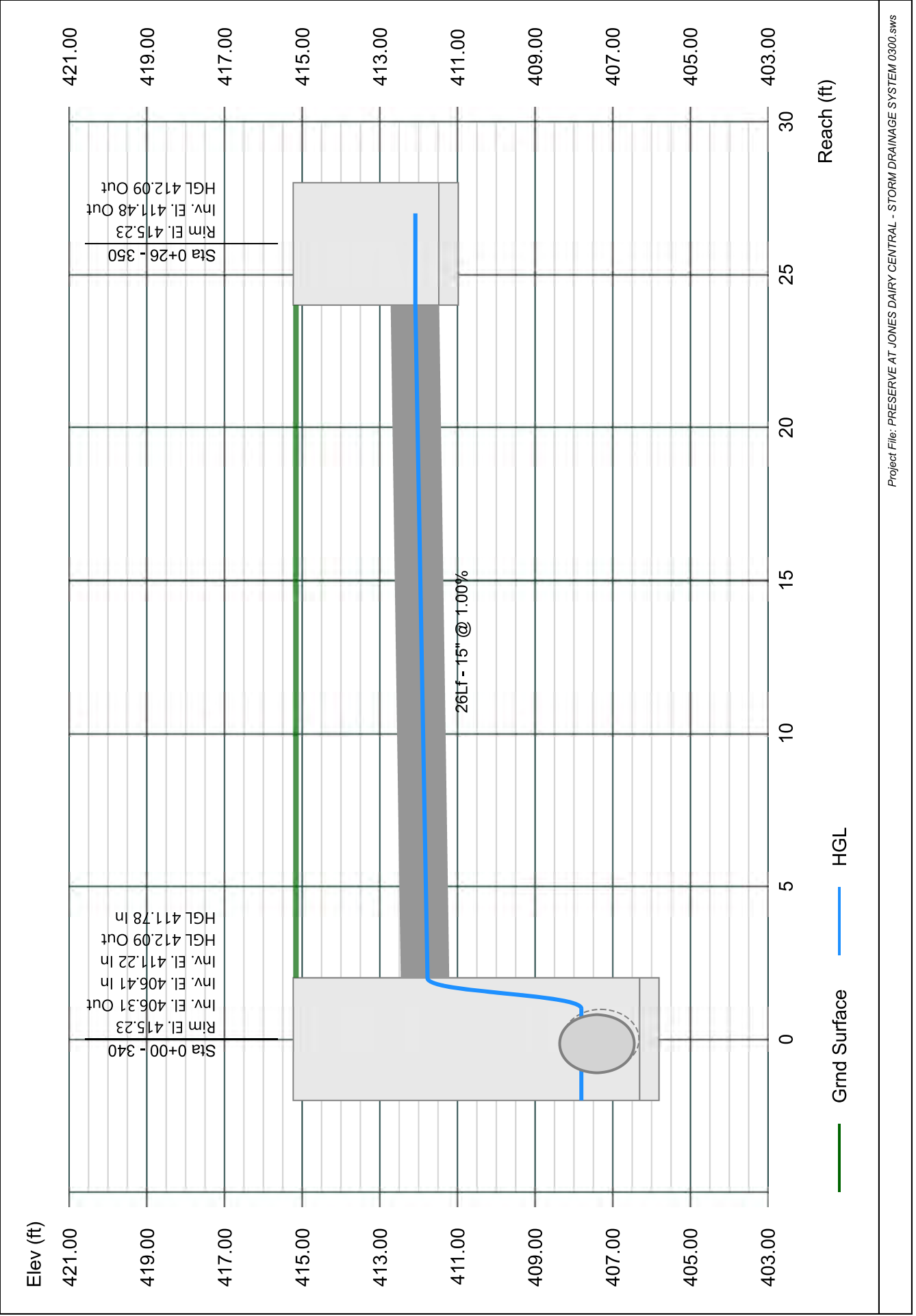

Line 48 - 333 TO 303

Stormwater Studio 2023 v 3.0.0.31

Project Name: Enter Project Name...

05-03-2023

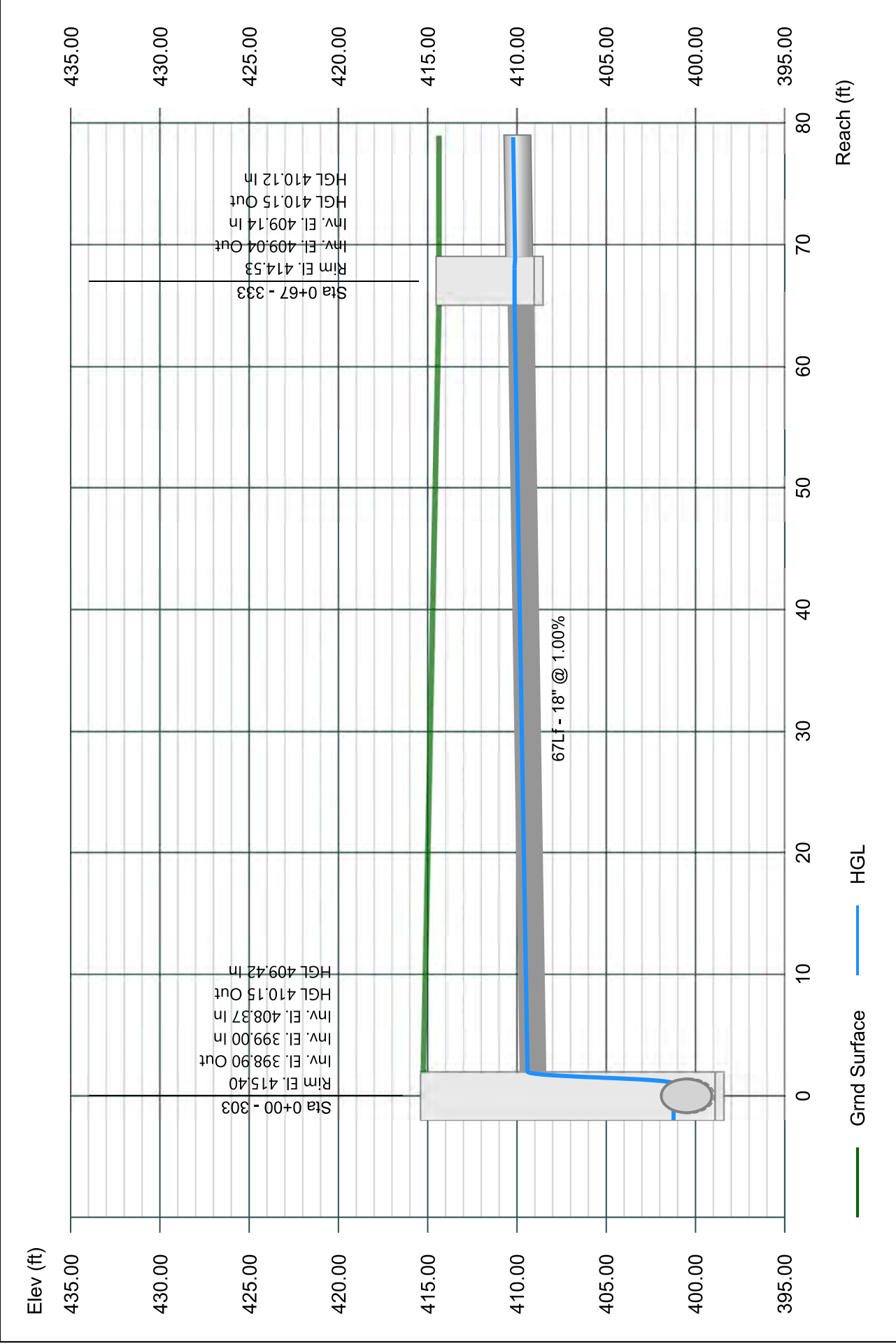

Line 49 - 334 TO 333

Stormwater Studio 2023 v 3.0.0.31

Project Name: Enter Project Name...

05-03-2023

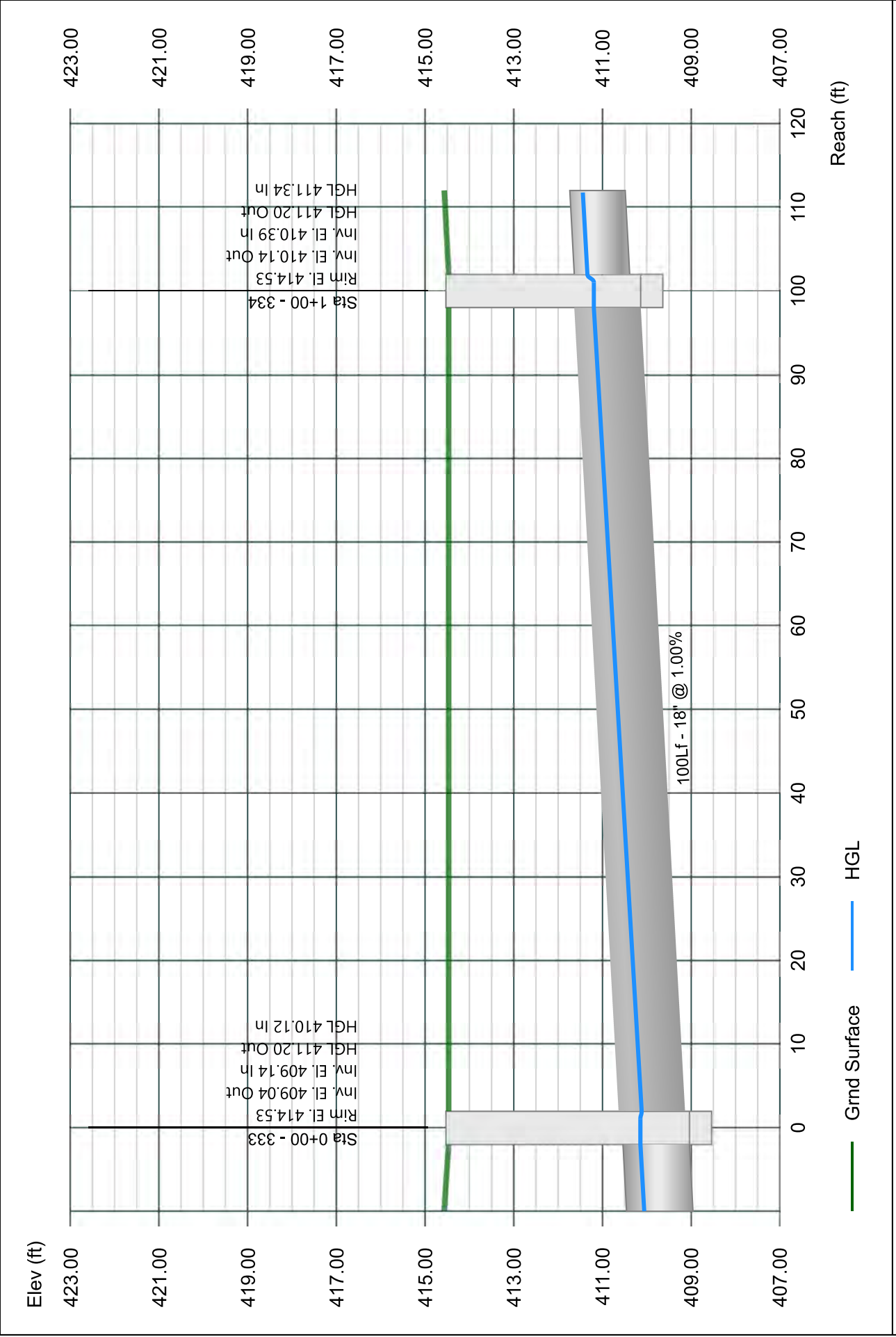

Line 50 - 335 TO 334

Stormwater Studio 2023 v 3.0.0.31

Project Name: Enter Project Name...

05-03-2023

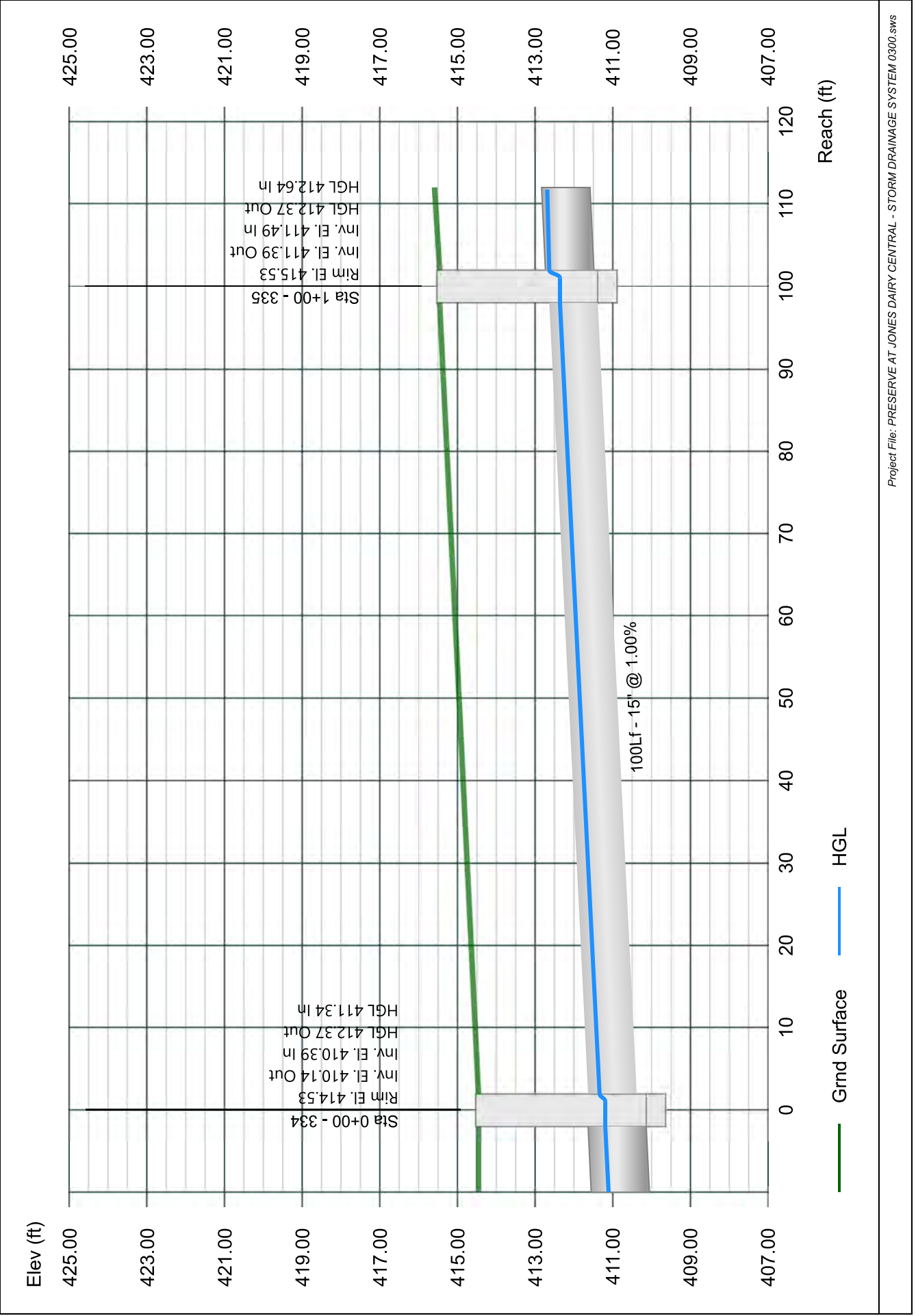

Line 51 - 336 TO 335

Stormwater Studio 2023 v 3.0.0.31

Project Name: Enter Project Name...

05-03-2023

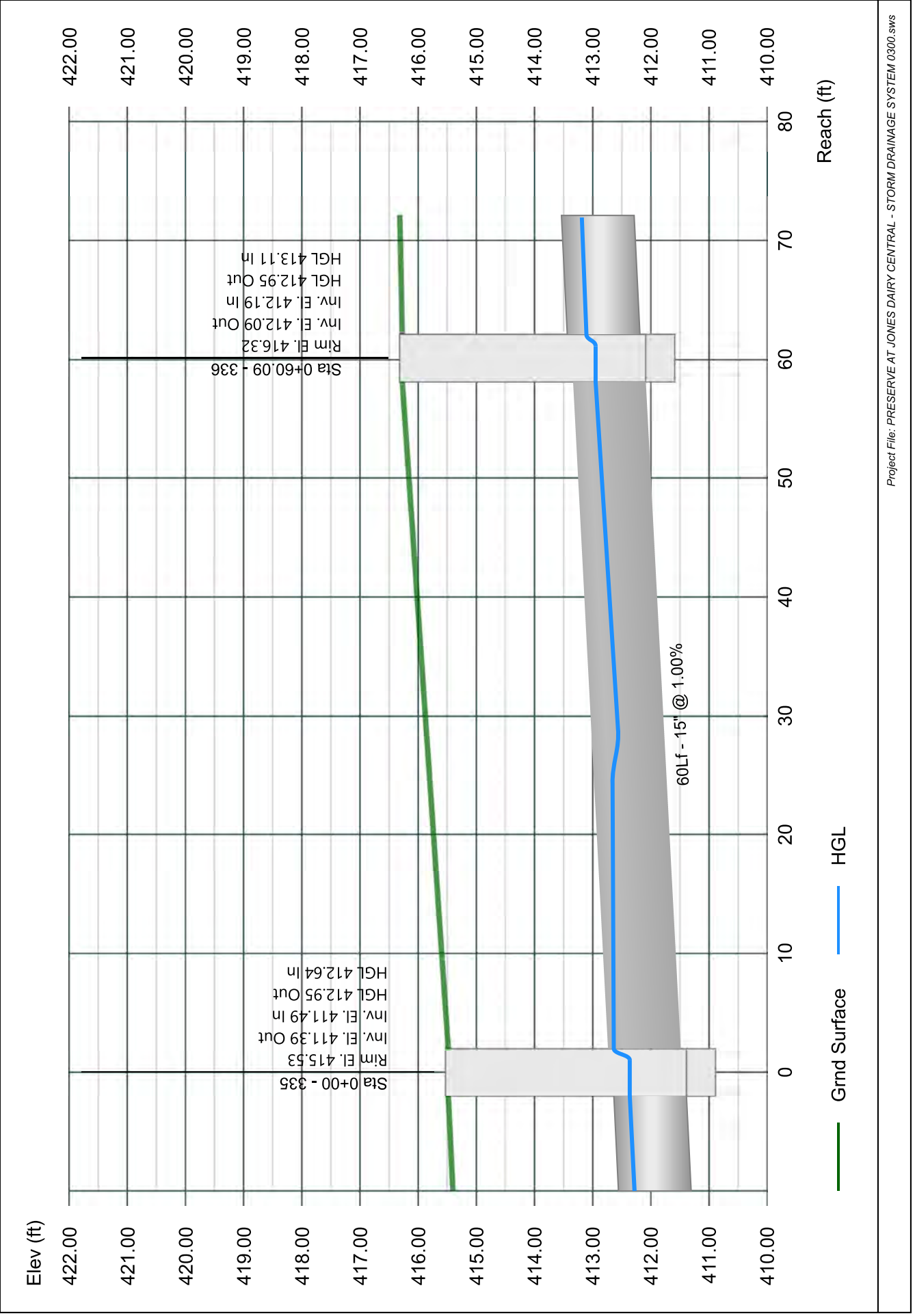

Line 52 - 337 TO 336

Stormwater Studio 2023 v 3.0.0.31

Project Name: Enter Project Name...

05-03-2023

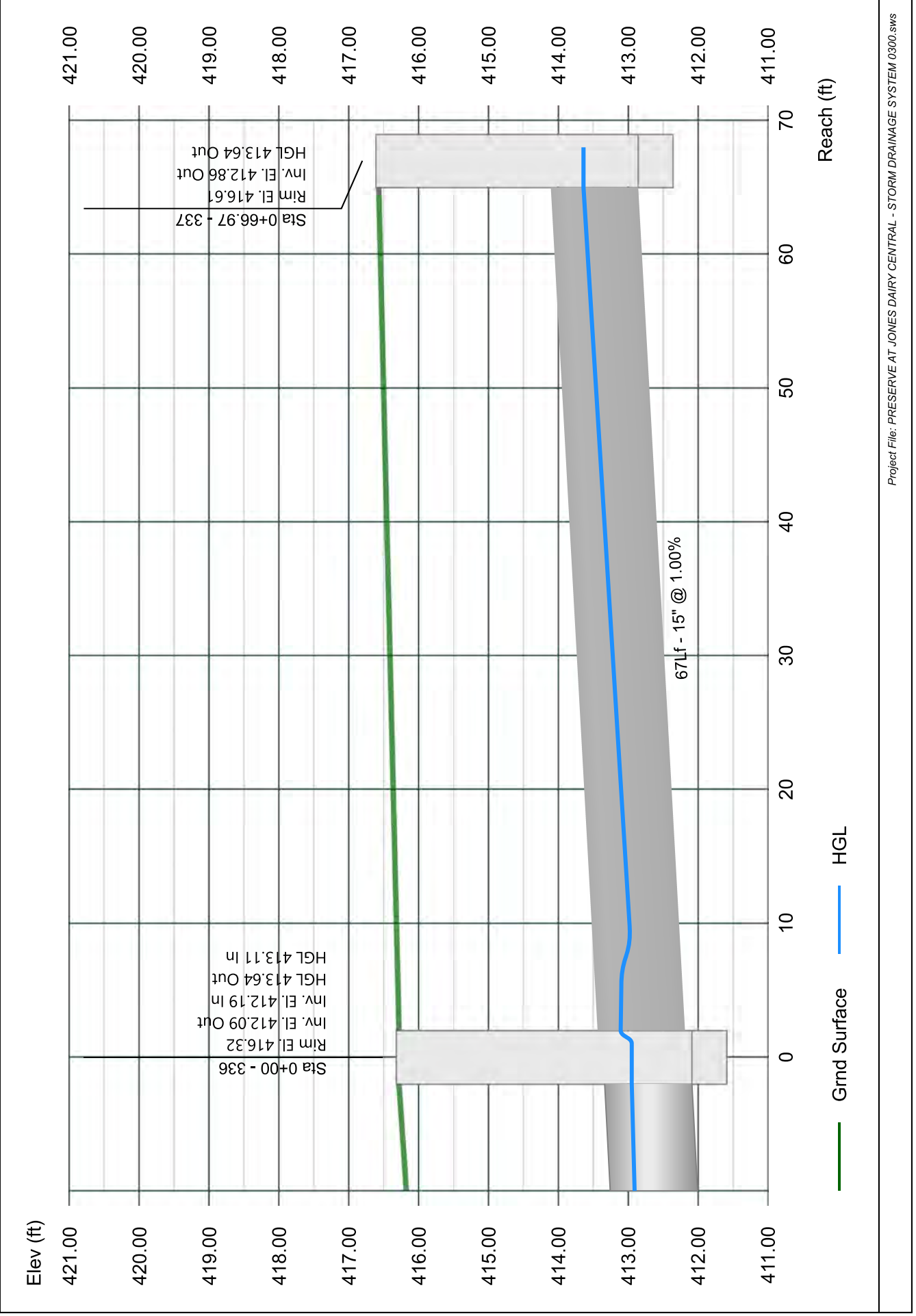

Line 53 - 322 TO 302

Stormwater Studio 2023 v 3.0.0.31

Project Name: Enter Project Name...

05-03-2023

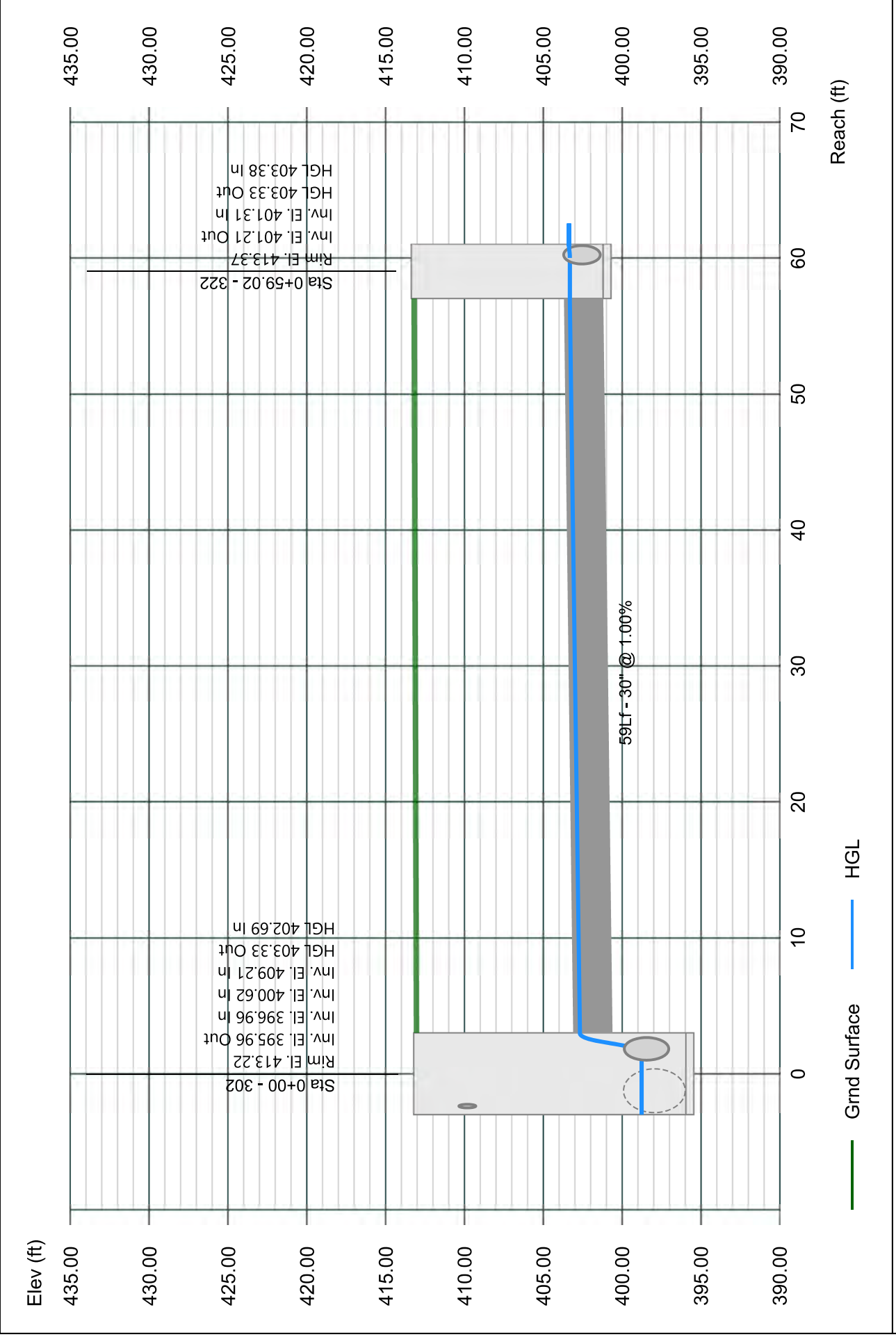

Line 54 - 323 TO 322

Stormwater Studio 2023 v 3.0.0.31

Project Name: Enter Project Name...

05-03-2023

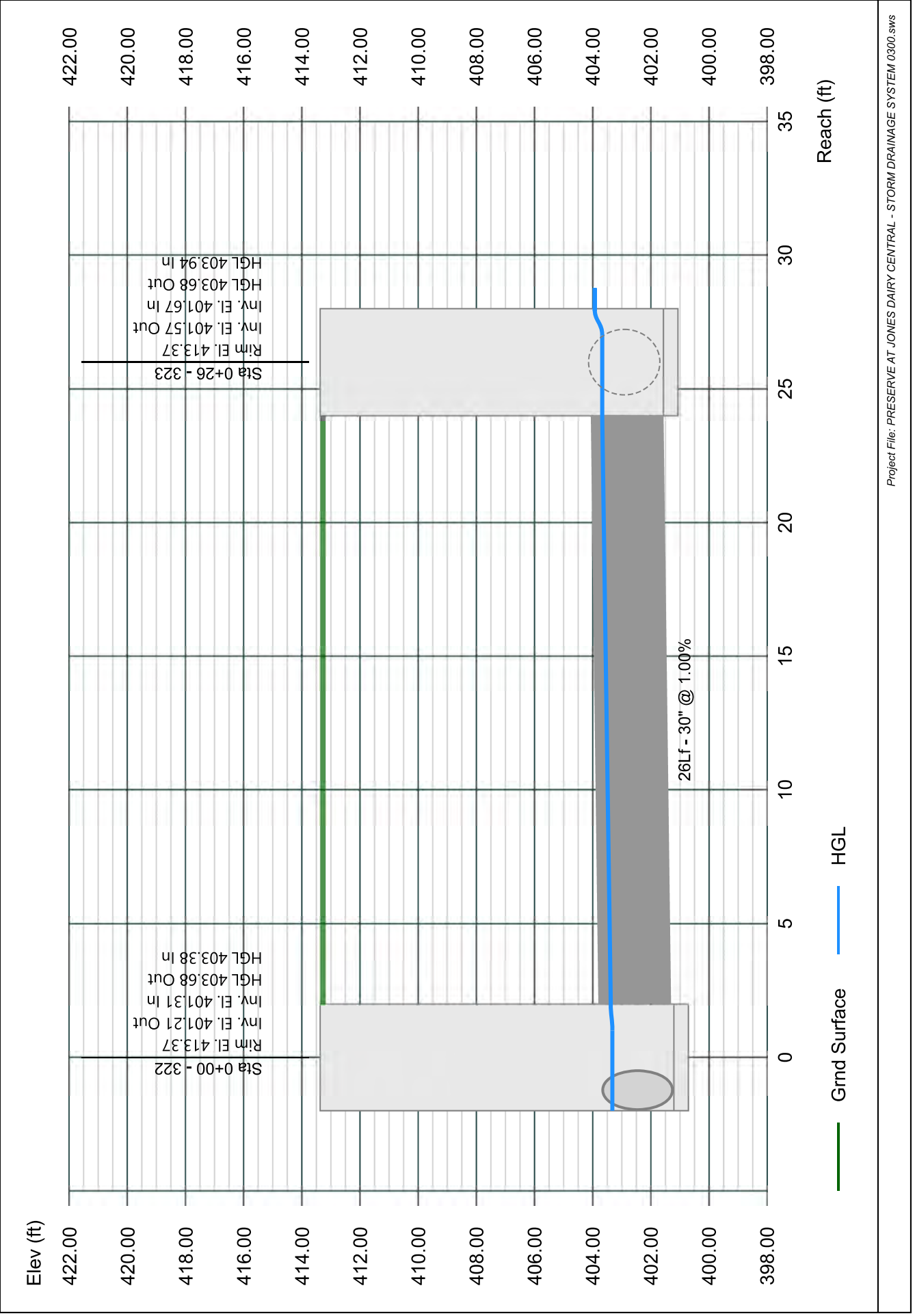

Line 55 - 324 TO 323

Stormwater Studio 2023 v 3.0.0.31

Project Name: Enter Project Name...

05-03-2023

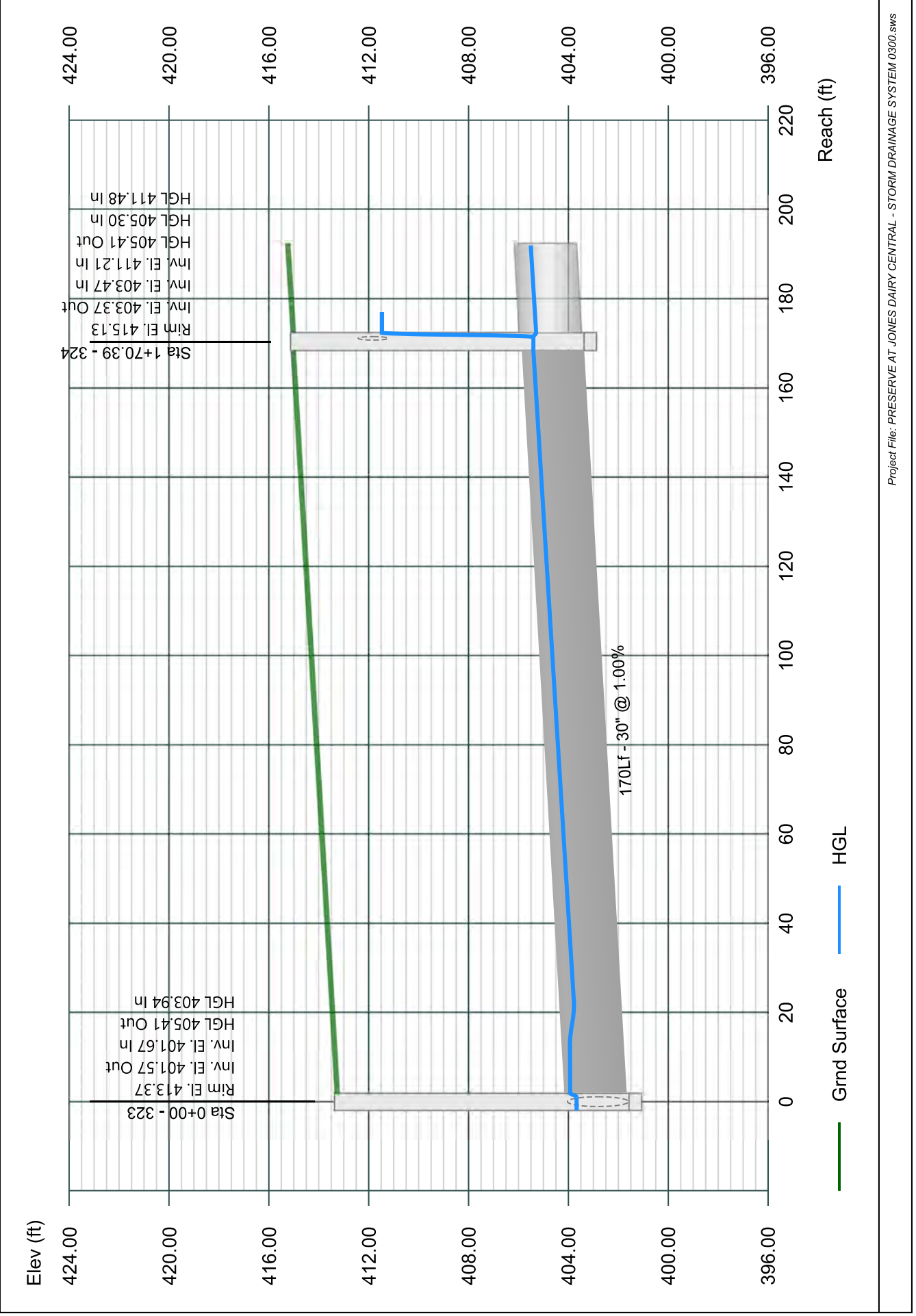

Line 56 - 325 TO 324

Stormwater Studio 2023 v 3.0.0.31

Project Name: Enter Project Name...

05-03-2023

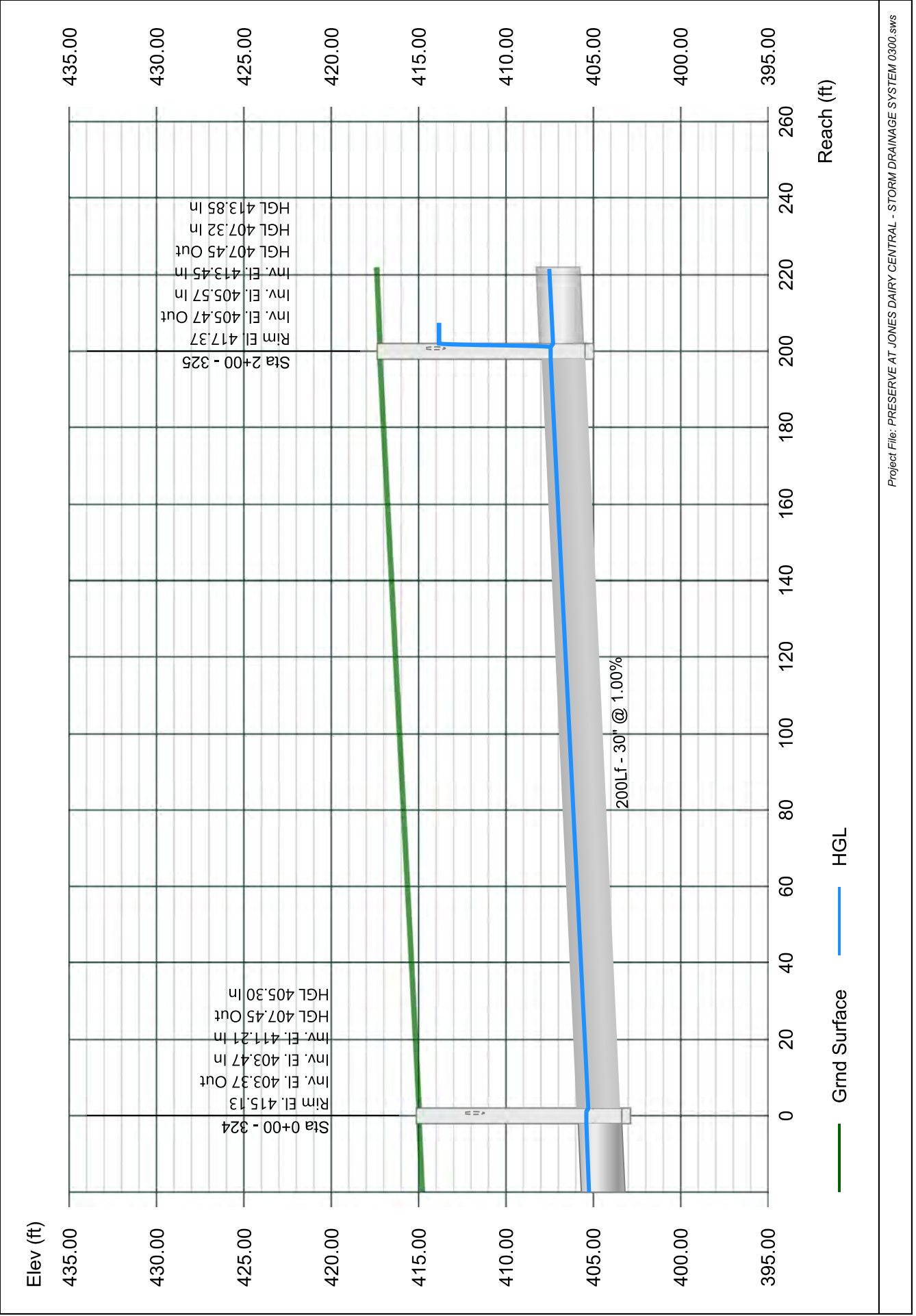

Line 57 - 326 TO 325

Stormwater Studio 2023 v 3.0.0.31

Project Name: Enter Project Name...

05-03-2023

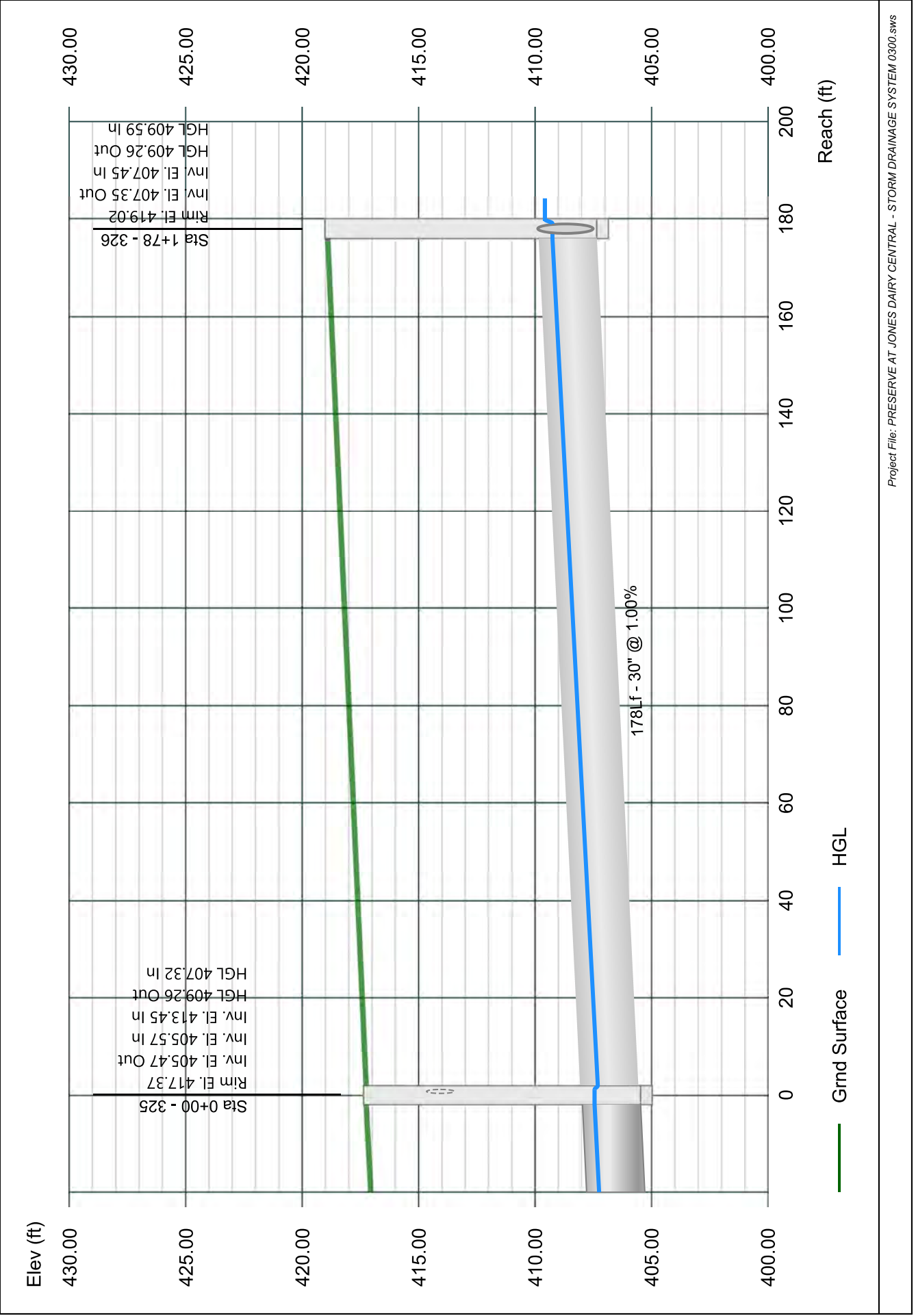

Line 58 - 326 TO 327

Stormwater Studio 2023 v 3.0.0.31

Project Name: Enter Project Name...

05-03-2023

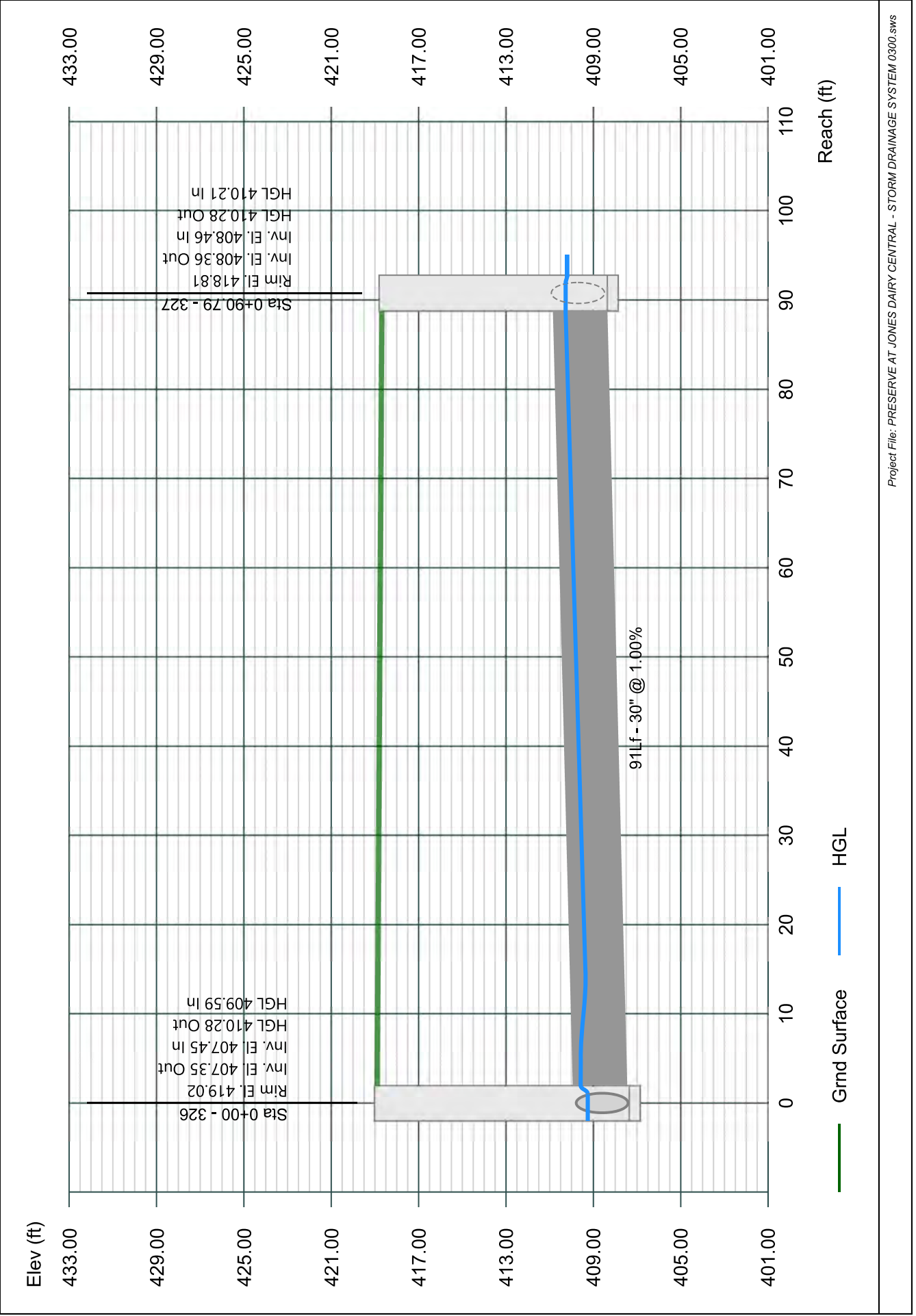

Line 59 - 328 TO 327

Stormwater Studio 2023 v 3.0.0.31

Project Name: Enter Project Name...

05-03-2023

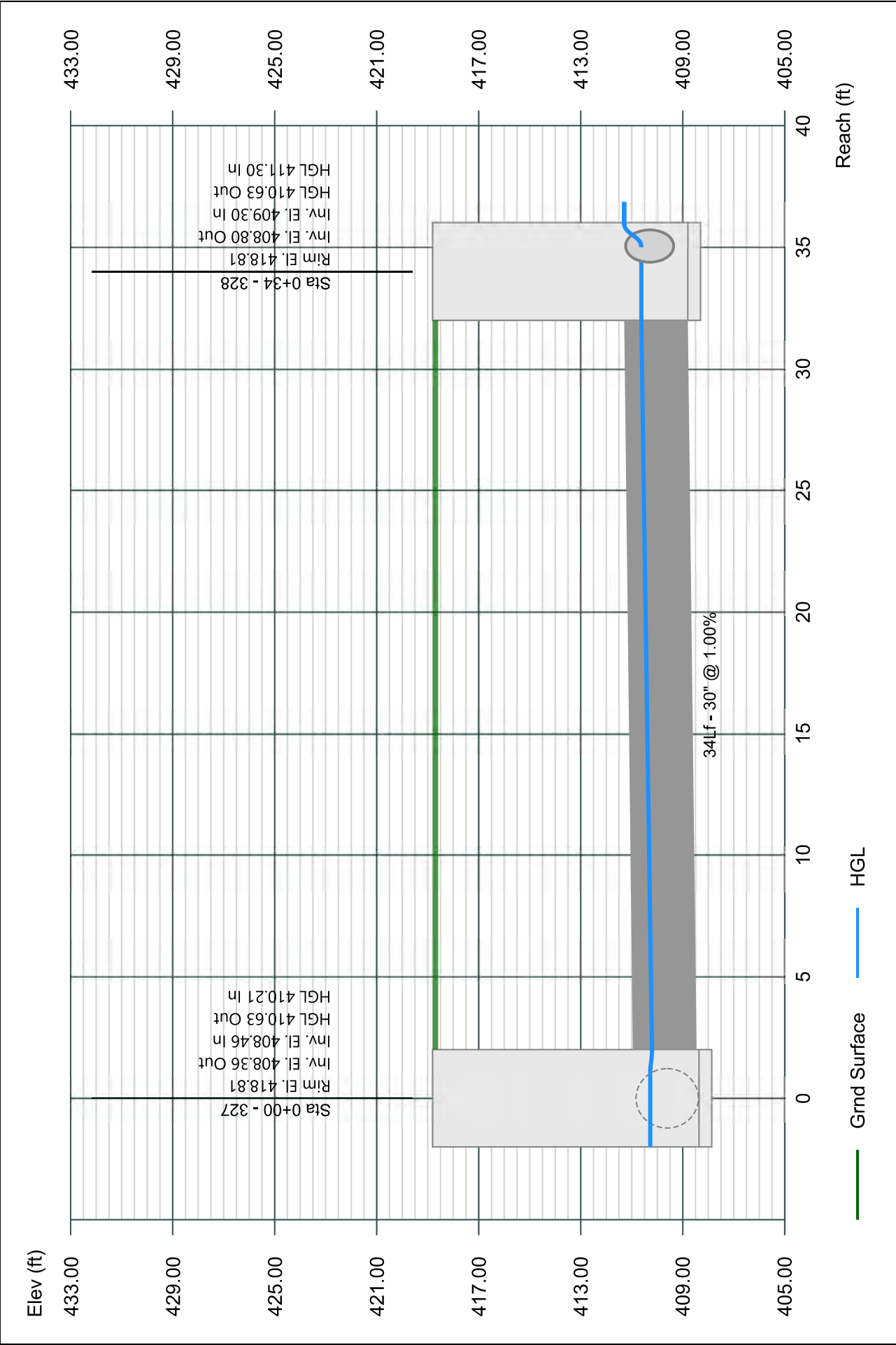

Line 60 - 329 TO 328

Stormwater Studio 2023 v 3.0.0.31

Project Name: Enter Project Name...

05-03-2023

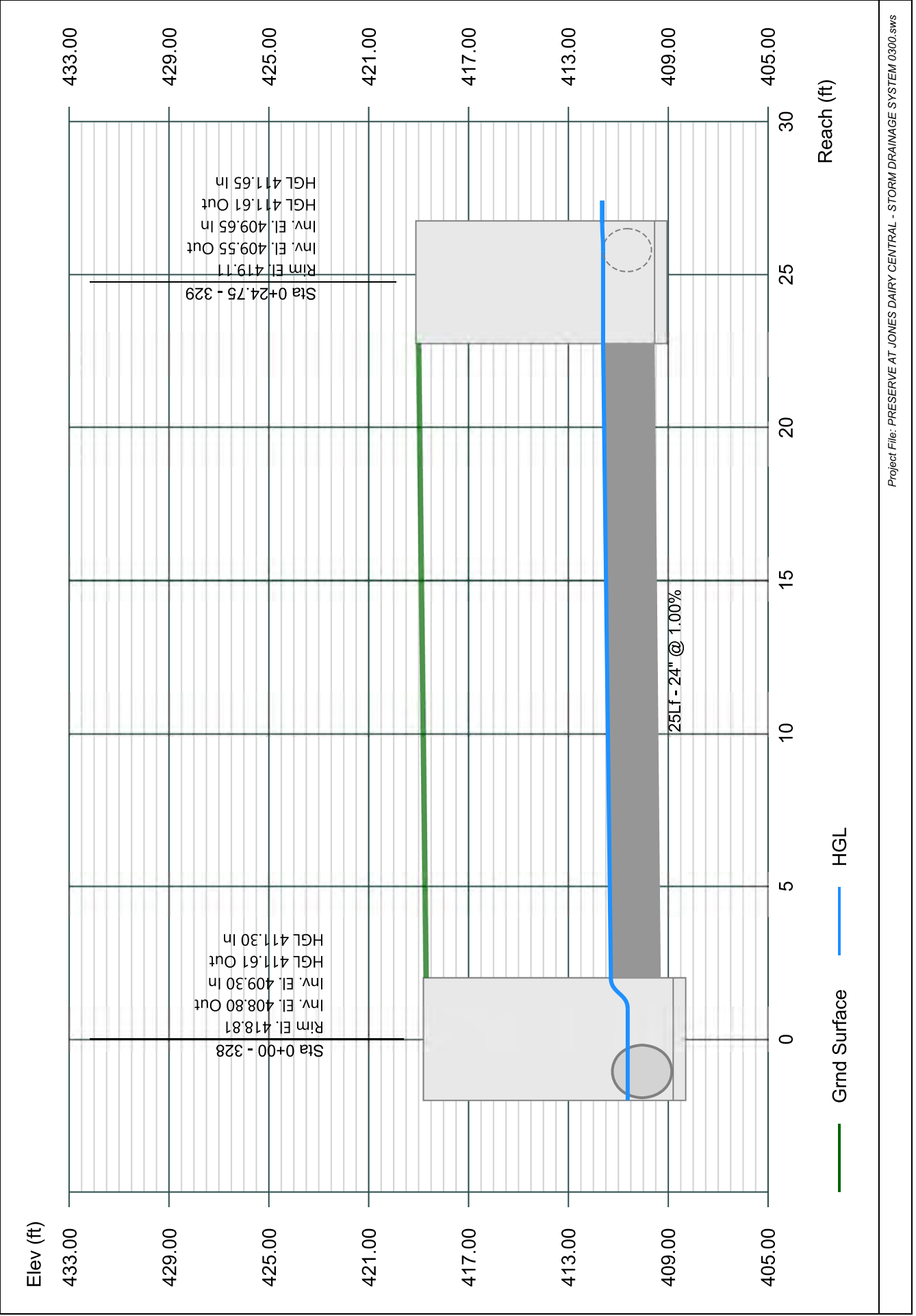

Line 61 - 330 TO 329

Stormwater Studio 2023 v 3.0.0.31

Project Name: Enter Project Name...

05-03-2023

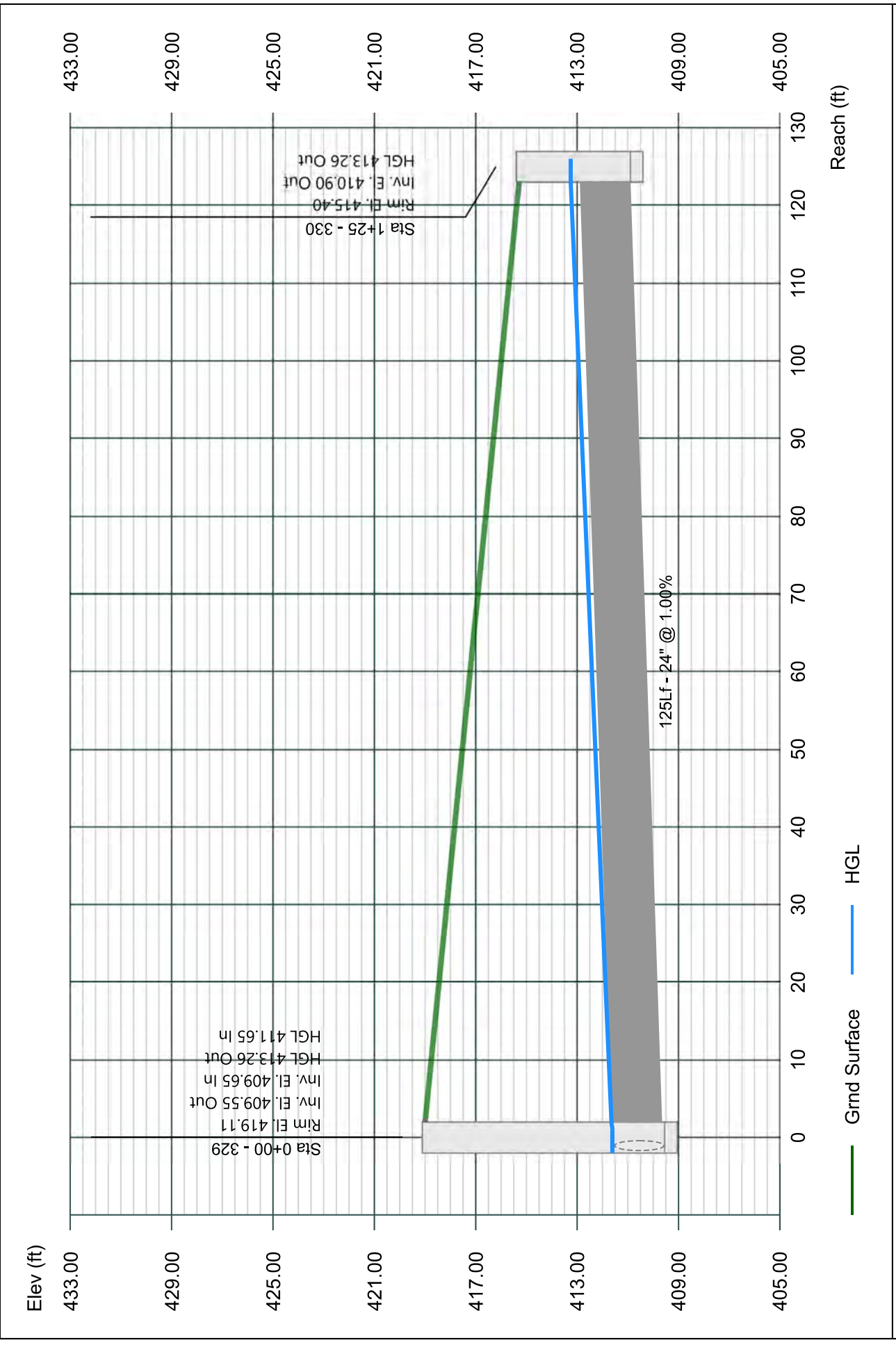

Line 62 - 332 TO 325

Stormwater Studio 2023 v 3.0.0.31

Project Name: Enter Project Name...

05-03-2023

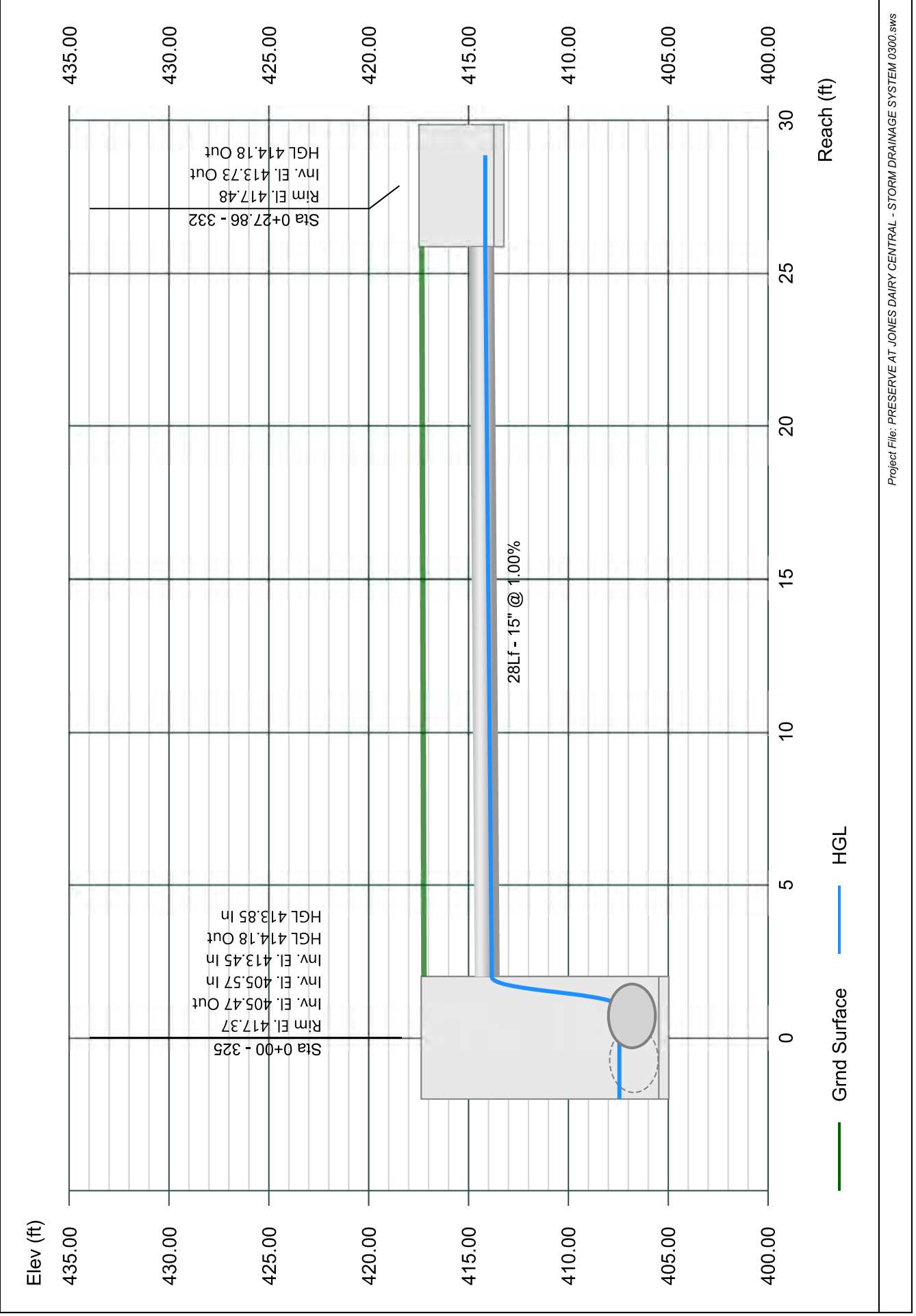

Line 63 - 331 TO 324

Stormwater Studio 2023 v 3.0.0.31

Project Name: Enter Project Name...

05-03-2023

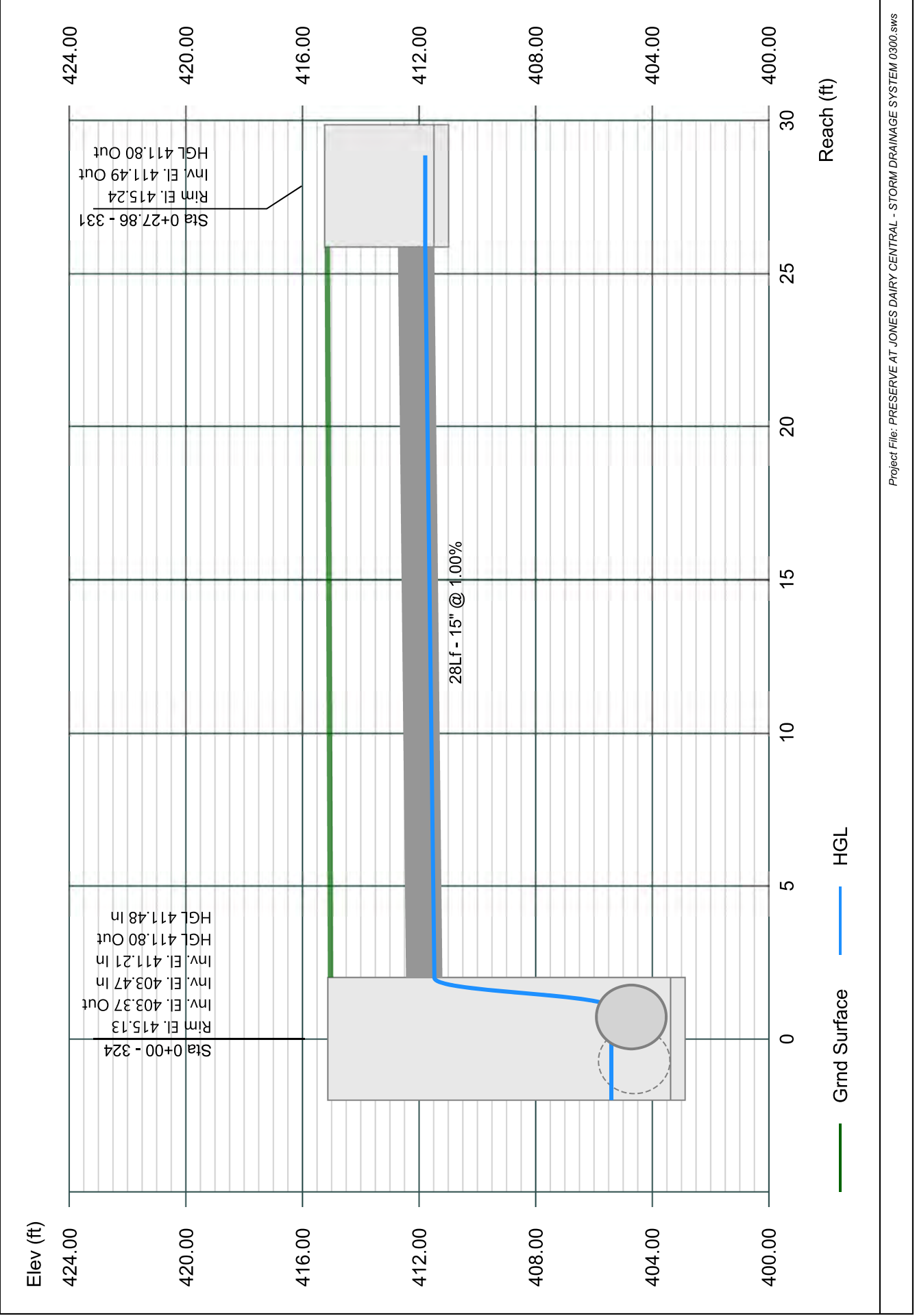

Line 64 - 321 TO 302

Stormwater Studio 2023 v 3.0.0.31

Project Name: Enter Project Name...

05-03-2023

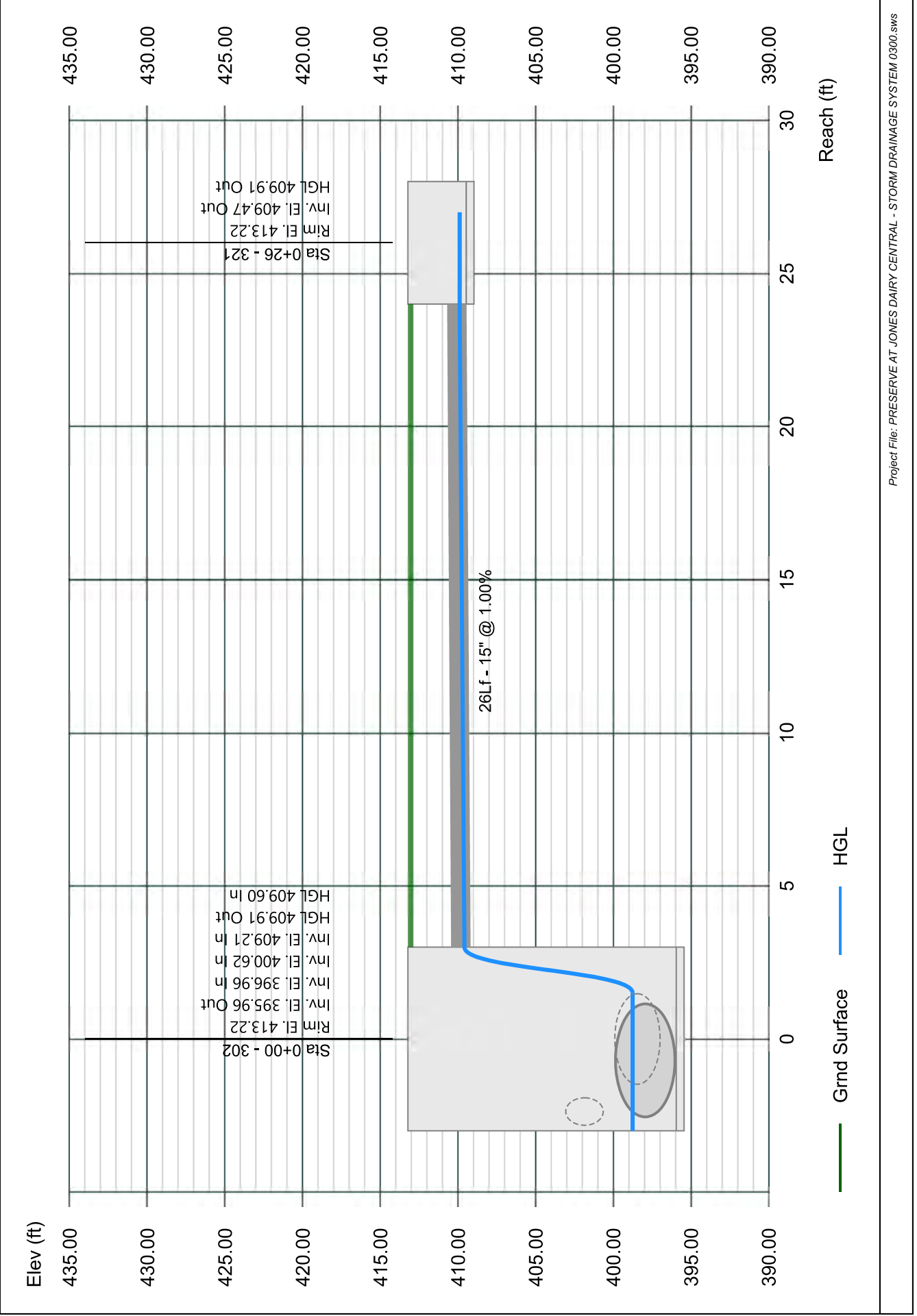

Line 65 - 366 TO 301

Stormwater Studio 2023 v 3.0.0.31

Project Name: Enter Project Name...

05-03-2023

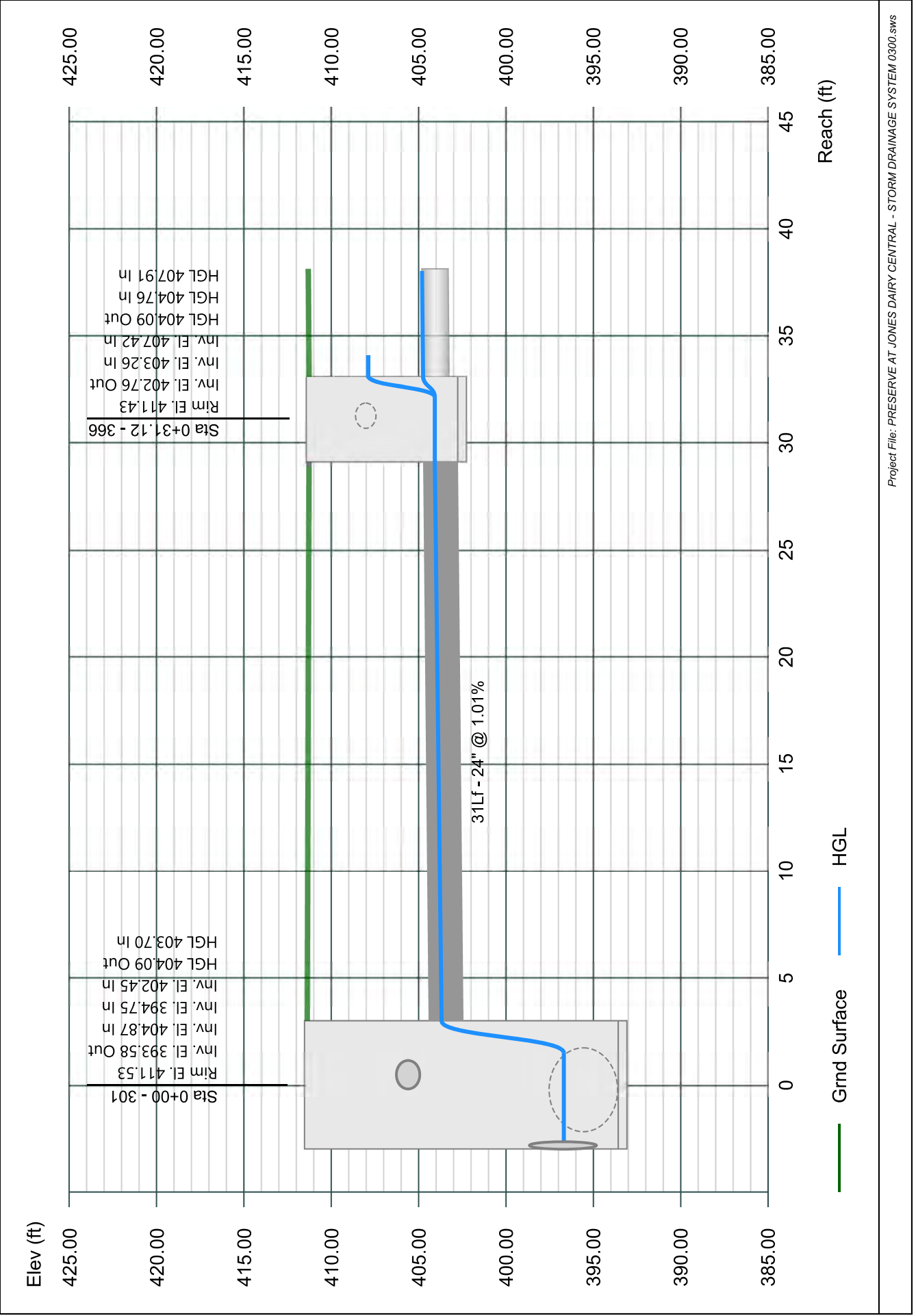

Line 66 - 367 TO 366

Stormwater Studio 2023 v 3.0.0.31

Project Name: Enter Project Name...

05-03-2023

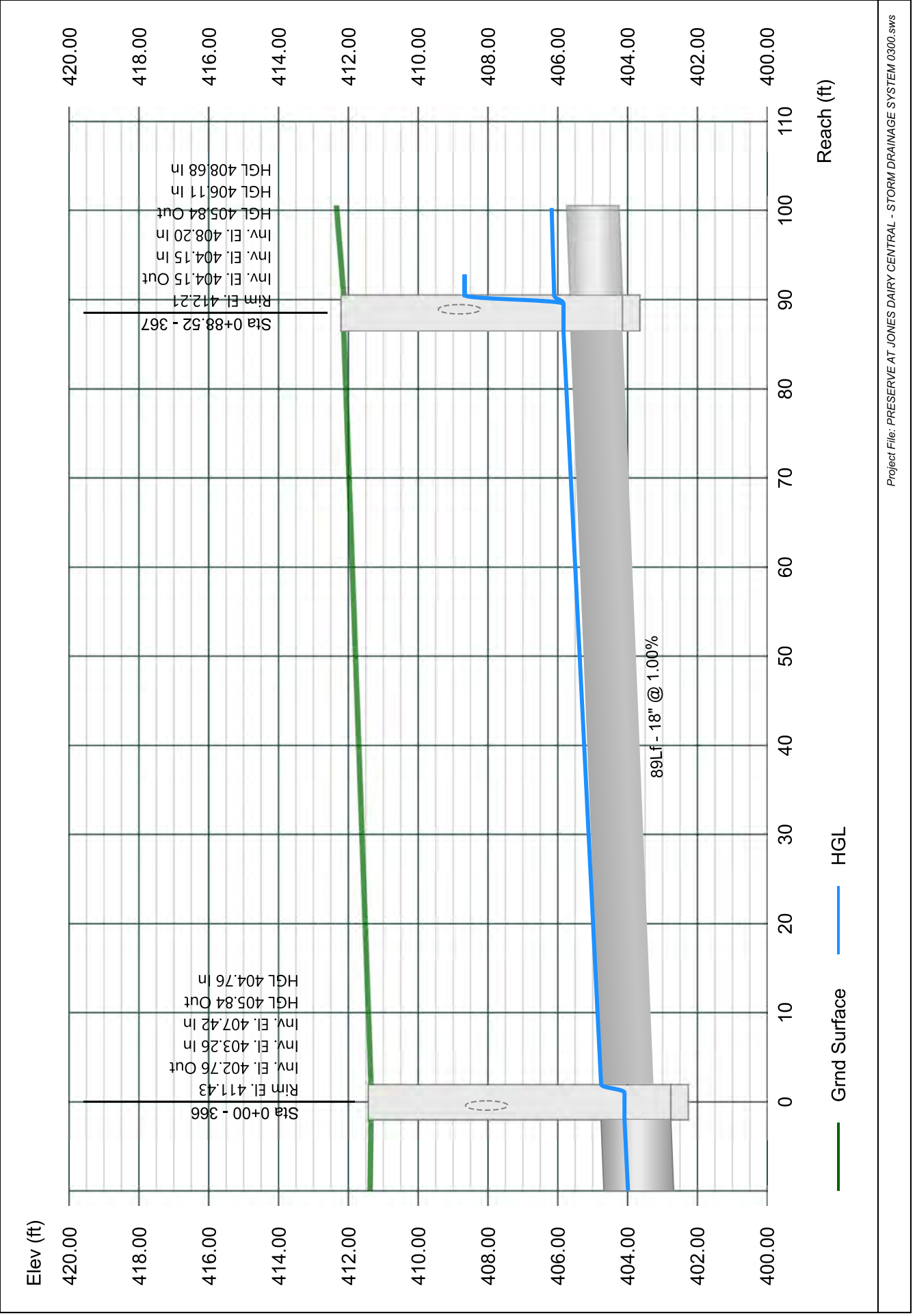

Line 67 - 368 TO 367

Stormwater Studio 2023 v 3.0.0.31

Project Name: Enter Project Name...

05-03-2023

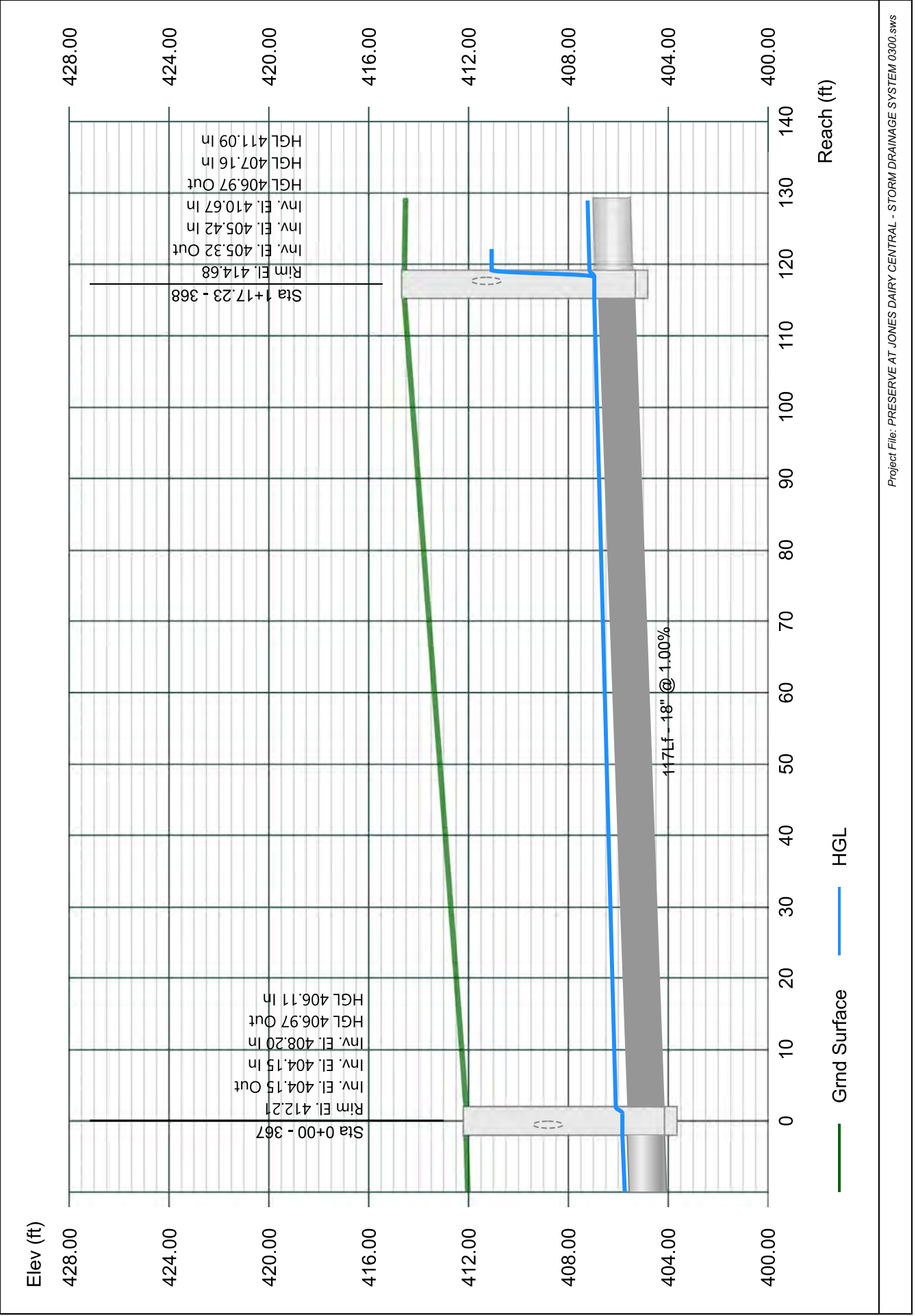

Line 68 - 368 TO 368

Stormwater Studio 2023 v 3.0.0.31

Project Name: Enter Project Name...

05-03-2023

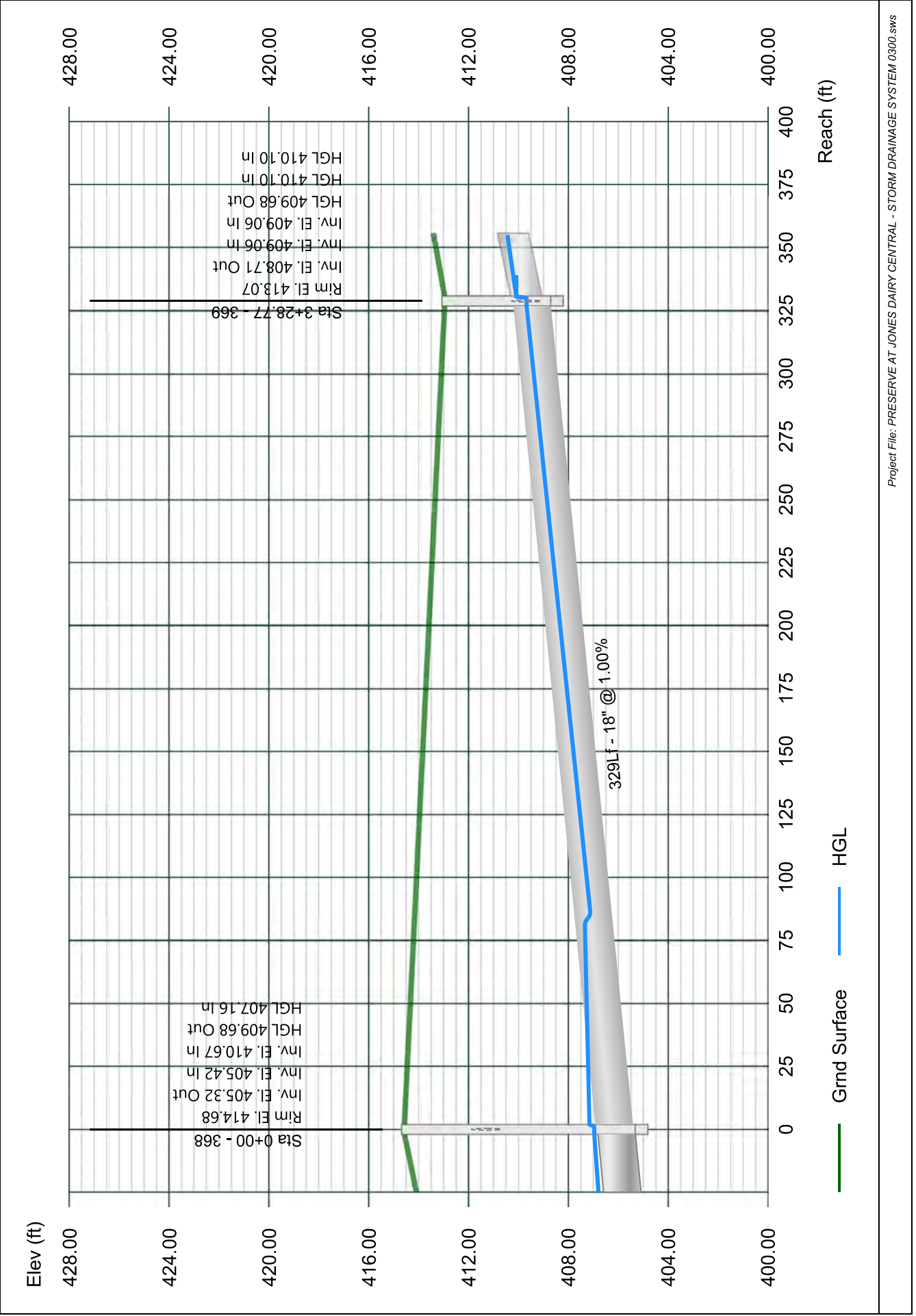

Line 69 - 370 TO 369

Stormwater Studio 2023 v 3.0.0.31

Project Name: Enter Project Name...

05-03-2023

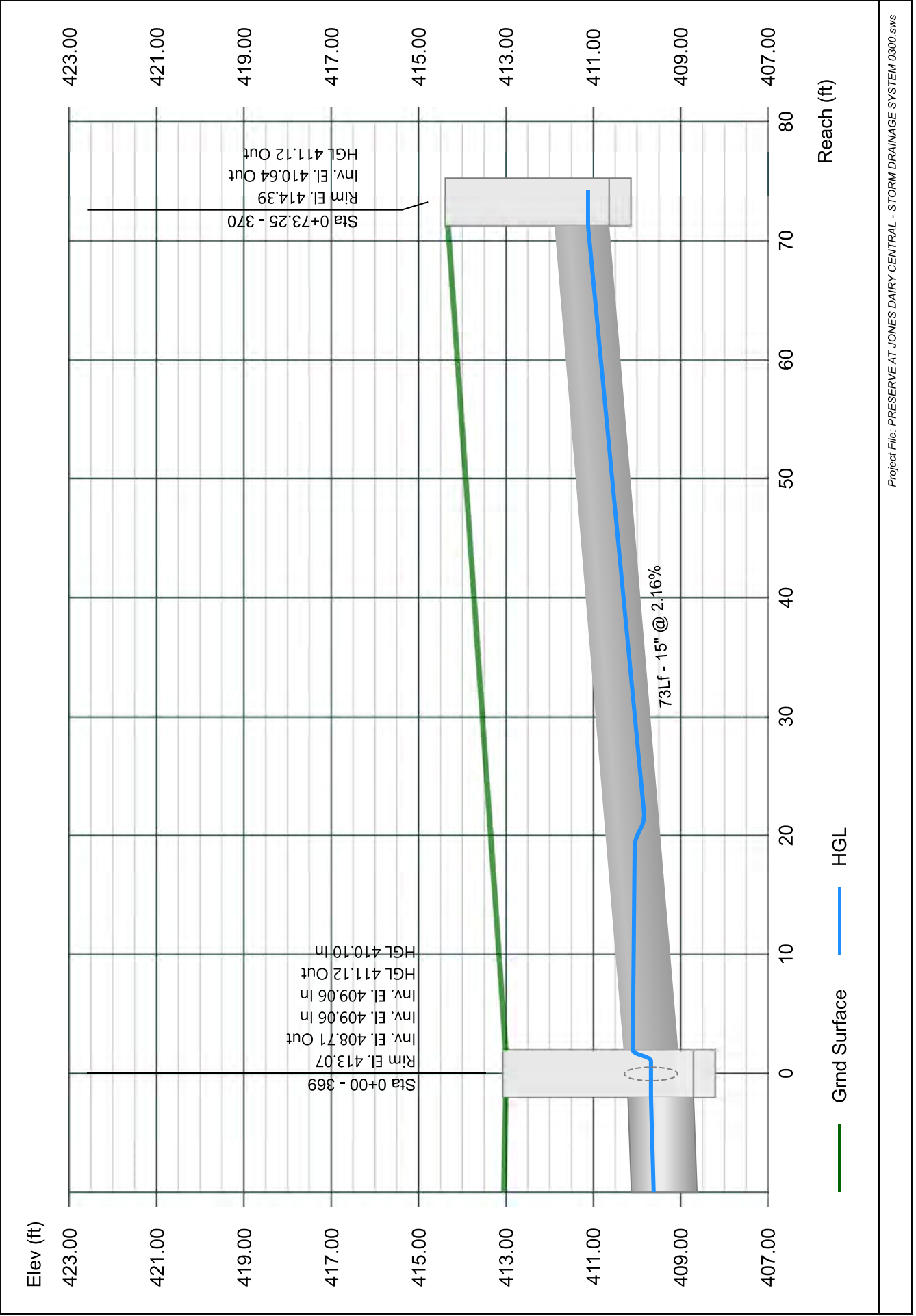

Line 70 - 374 TO 369

Stormwater Studio 2023 v 3.0.0.31

Project Name: Enter Project Name...

05-03-2023

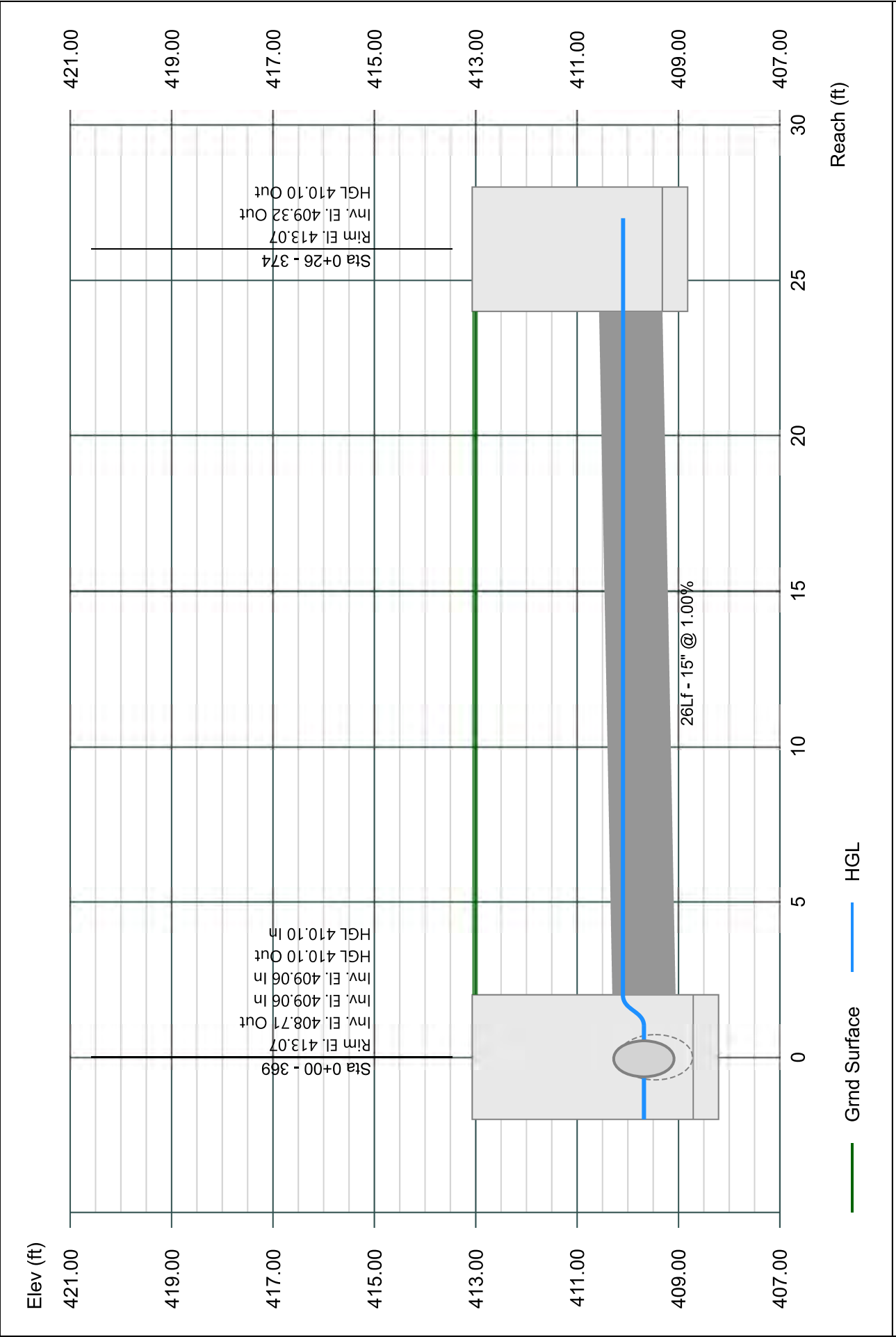

Line 71 - 383 TO 368

Stormwater Studio 2023 v 3.0.0.31

Project Name: Enter Project Name...

05-03-2023

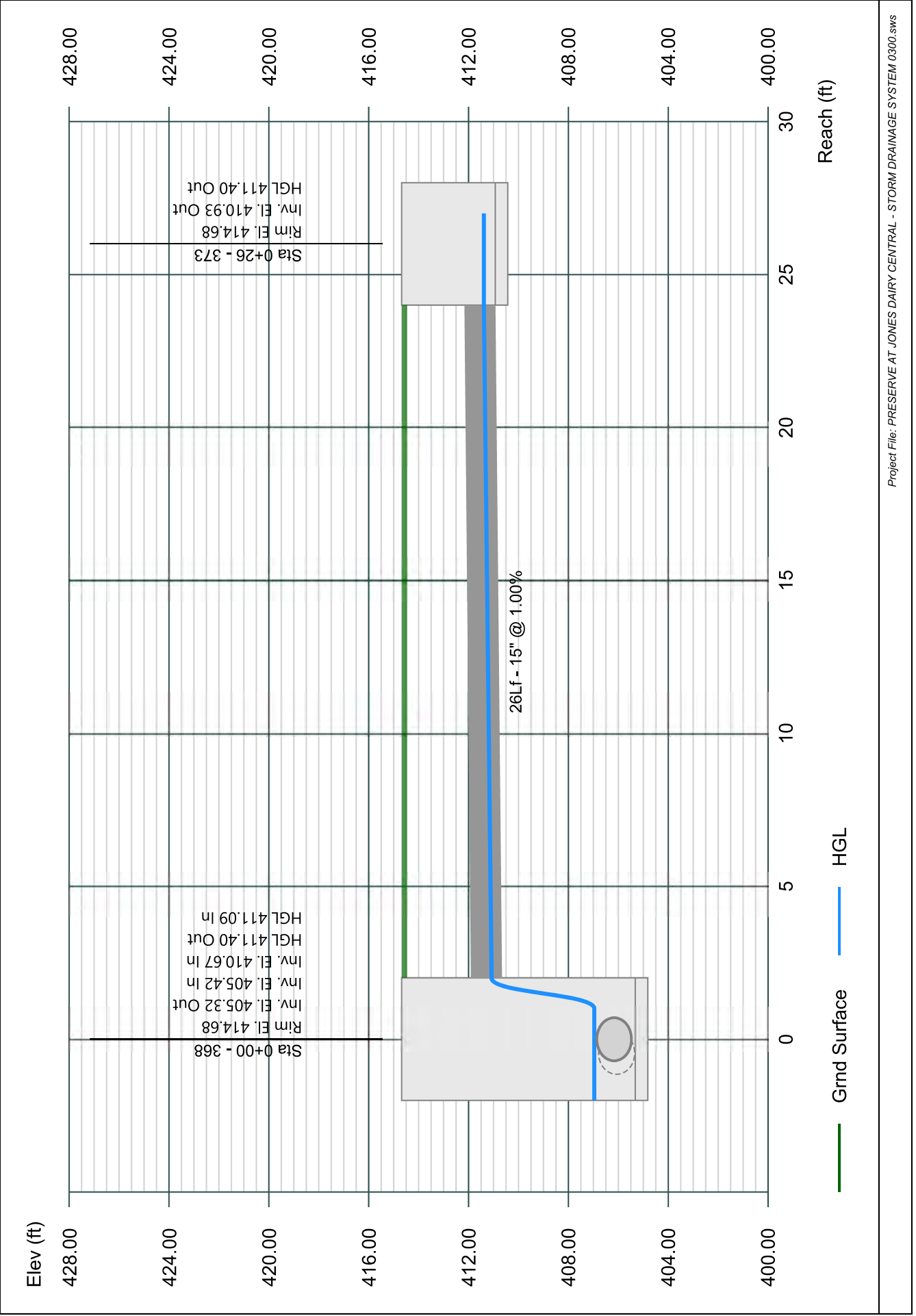

Line 72 - 372 TO 367

Stormwater Studio 2023 v 3.0.0.31

Project Name: Enter Project Name...

05-03-2023

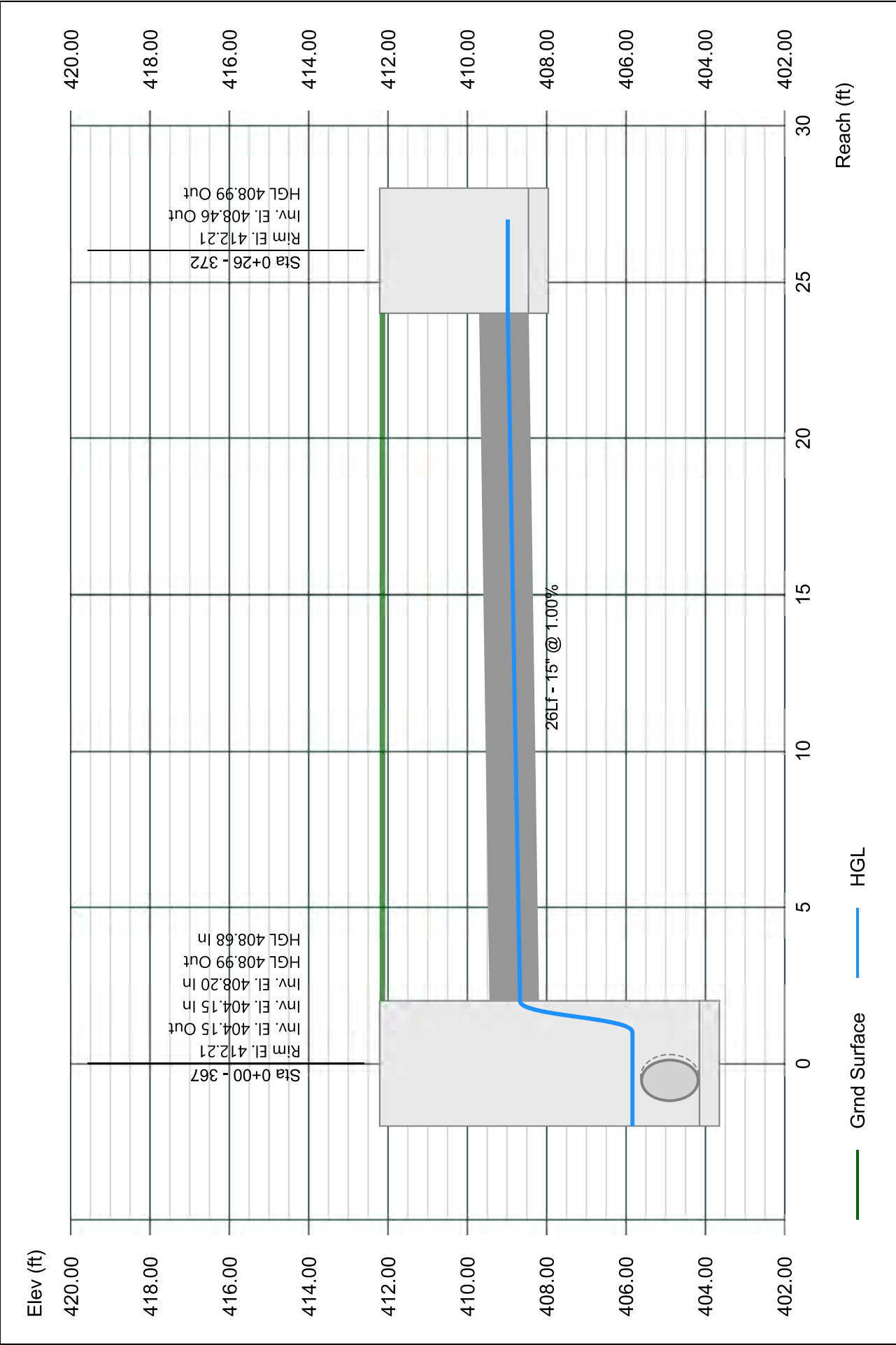

Line 73 - 371 TO 366

Stormwater Studio 2023 v 3.0.0.31

Project Name: Enter Project Name...

05-03-2023

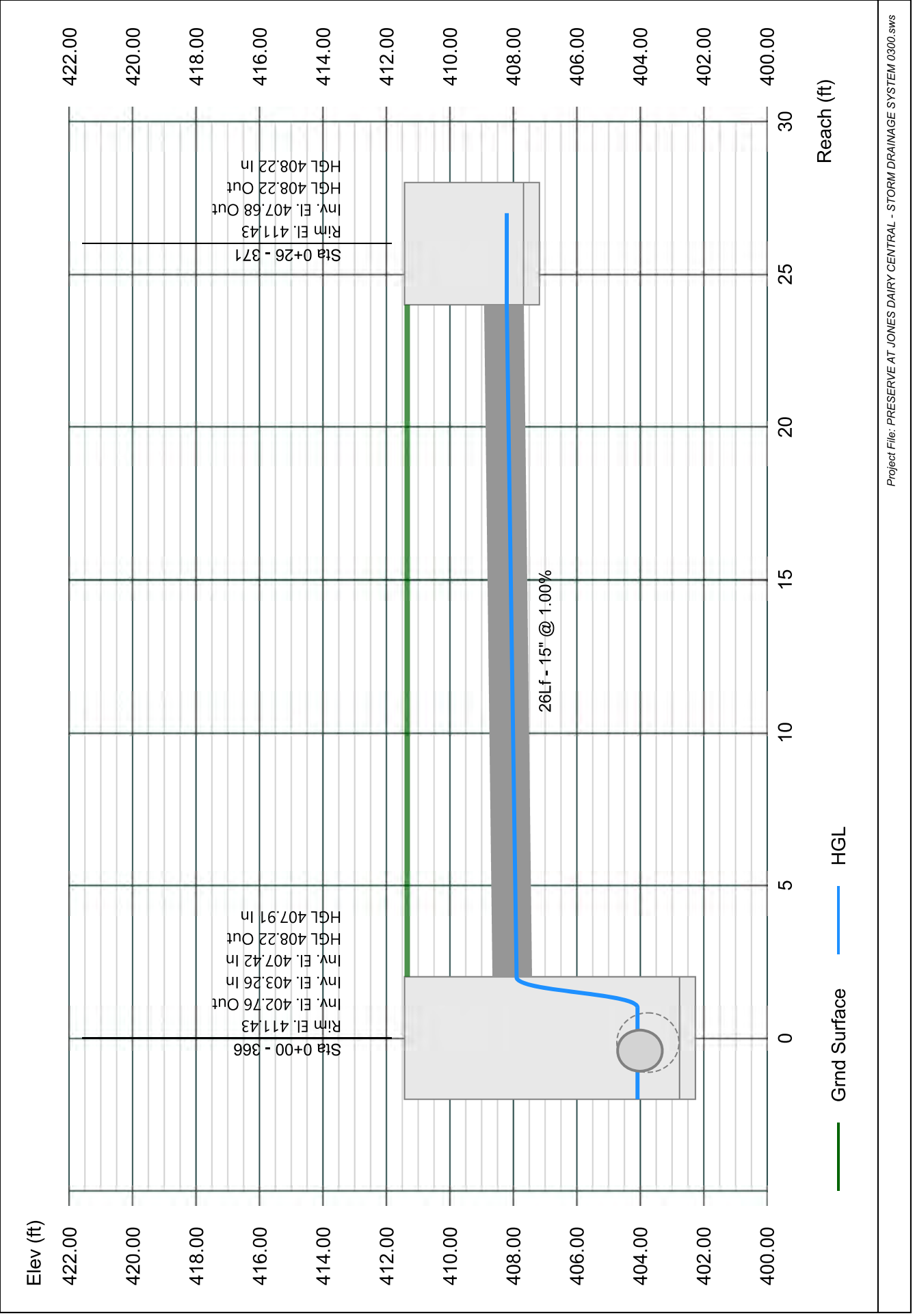

APPENDIX D – STORM SEWER GUTTER SPREAD CALCULATIONS

Spread Report

Stormwater Studio 2024 v 3.0.0.33

Project Name: Enter Project Name...

01-19-2024

Line No.	Inlet ID	Area ID	Junct Type	Drain Area (ac)	Runoff Coeff (C)	i Inlet (in/hr)	Incr Q (cfs)	Q Carry (cfs)	Q Capt (cfs)	Q Bypass (cfs)	Gutter Spread (ft)	Inlet Spread (ft)
1	101		Comb.	0.070	0.80	4.00	0.22	0.04	0.25	0.01	3.10	1.69
2	102		Comb.	0.080	0.80	4.00	0.26	0.14	0.37	0.03	3.50	1.97
3	103		Comb.	0.180	0.70	4.00	0.50	0.07	0.58	0.00	2.46	2.46
4	104		Comb.	0.170	0.70	4.00	0.48	0.19	0.59	0.07	3.68	2.19
5	105		Comb.	0.250	0.70	4.00	0.70	0.45	0.96	0.19	4.38	3.14
6	106		Comb.	0.360	0.70	4.00	1.01	0.04	0.89	0.16	4.25	2.97
7	107		Comb.	0.140	0.70	4.00	0.39	0.13	0.48	0.04	3.43	1.91
8	108		Comb.	0.320	0.70	4.00	0.90	0.00	0.77	0.13	4.03	2.69
9	109		Comb.	0.300	0.07	4.00	0.08	0.00	0.08	0.00	2.17	0.97
10	110		Comb.	0.590	0.70	4.00	1.65	0.01	1.30	0.37	4.93	3.84
11	111		Comb.	0.100	0.70	4.00	0.28	0.01	0.28	0.01	2.90	1.54
12	112		Comb.	0.100	0.70	4.00	0.28	0.00	0.27	0.01	3.18	1.73
13	113		MH	0.001	0.80	4.00	0.00
14	114		Comb.	0.100	0.70	4.00	0.28	0.02	0.30	0.00	0.92	1.73
15	115		MH	0.001	0.80	4.00	0.00
16	116		Comb.	0.140	0.70	4.00	0.39	0.00	0.38	0.01	2.87	1.52
17	117		Comb.	0.120	0.70	4.00	0.34	0.00	0.32	0.02	3.33	1.85
18	118		Comb.	0.110	0.70	4.00	0.31	0.00	0.29	0.02	3.25	1.79
19	119		Comb.	0.120	0.70	4.00	0.34	0.02	0.33	0.02	3.38	1.89
20	120		Comb.	0.270	0.70	4.00	0.76	0.19	0.95	0.00	3.21	3.21
21	121		Comb.	0.250	0.70	4.00	0.70	0.08	0.78	0.00	2.96	2.96
22	122		Comb.	0.140	0.70	4.00	0.39	0.18	0.57	0.00	2.46	2.46
23	123		Comb.	0.200	0.70	4.00	0.56	0.51	0.89	0.18	4.70	3.57
24	124		Comb.	0.170	0.70	4.00	0.48	0.10	0.52	0.06	3.85	2.44

Notes: IDF File = Gutter Spread - 4 inches per hour.idf, Return Period = 2-yrs.

Project File: PRESERVE AT JONES DAIRY CENTRAL - STORM DRAINAGE SYSTEM 0100.sws

Spread Report

Stormwater Studio 2024 v 3.0.0.33

Project Name: Enter Project Name...

01-19-2024

Line No.	Inlet ID	Area ID	Junct Type	Drain Area (ac)	Runoff Coeff (C)	i Inlet (in/hr)	Incr Q (cfs)	Q Carry (cfs)	Q Capt (cfs)	Q Bypass (cfs)	Gutter Spread (ft)	Inlet Spread (ft)
25	125		Comb.	0.110	0.70	4.00	0.31	0.46	0.67	0.10	4.23	2.94
26	126		Comb.	0.190	0.70	4.00	0.53	0.15	0.60	0.08	4.05	2.72
27	127		Comb.	0.230	0.70	4.00	0.64	0.30	0.80	0.15	4.53	3.34
28	128		Comb.	0.330	0.70	4.00	0.92	0.15	0.89	0.18	4.70	3.57
29	129		Comb.	0.340	0.70	4.00	0.95	0.00	0.80	0.15	4.53	3.34
30	130		Comb.	0.300	0.70	4.00	0.84	0.00	0.72	0.12	4.35	3.12
31	131		Comb.	0.590	0.70	4.00	1.65	0.00	1.27	0.38	5.43	4.47
32	132		Dp-Curb	0.330	0.65	4.00	0.86	0.00	0.86	0.00	1.37	1.69
33	133		Dp-Curb	0.210	0.65	4.00	0.55	0.00	0.55	0.00	0.49	1.25
34	134		Dp-Curb	0.410	0.65	4.00	1.07	0.00	1.07	0.00	1.90	1.95
35	135		Dp-Curb	0.540	0.65	4.00	1.40	0.00	1.40	0.00	2.35	2.35
36	136		Comb.	0.660	0.70	4.00	1.85	0.00	1.40	0.45	5.65	4.72
37	137		Dp-Curb	0.500	0.65	4.00	1.30	0.00	1.30	0.00	2.23	2.23
38	138		Dp-Curb	0.700	0.65	4.00	1.82	0.00	1.82	0.00	2.79	2.79
39	139		Dp-Curb	0.650	0.65	4.00	1.69	0.00	1.69	0.00	2.66	2.66
40	140		Comb.	0.100	0.70	4.00	0.28	0.00	0.28	0.00	0.92	1.73
41	141		Comb.	0.360	0.70	4.00	1.01	0.10	0.92	0.19	4.53	3.34
42	142		Comb.	0.280	0.70	4.00	0.78	0.00	0.68	0.10	4.05	2.72
43	143		Comb.	0.470	0.70	4.00	1.32	0.00	1.06	0.26	4.78	3.67
44	144		Comb.	0.250	0.70	4.00	0.70	0.00	0.62	0.08	3.90	2.52
45	145		Comb.	0.110	0.70	4.00	0.31	0.00	0.29	0.02	3.20	1.76
46	146		Dp-Curb	0.730	0.65	4.00	1.90	0.00	1.90	0.00	2.87	2.87
47	147		Dp-Curb	0.520	0.65	4.00	1.35	0.00	1.35	0.00	2.29	2.29
48	148		Comb.	0.370	0.70	4.00	1.04	0.00	1.04	0.00	3.46	3.46

Notes: IDF File = Gutter Spread - 4 inches per hour.idf, Return Period = 2-yrs.

Project File: PRESERVE AT JONES DAIRY CENTRAL - STORM DRAINAGE SYSTEM 0100.sws

Spread Report

Stormwater Studio 2024 v 3.0.0.33

Project Name: Enter Project Name...

01-19-2024

Line No.	Inlet ID	Area ID	Junct Type	Drain Area (ac)	Runoff Coeff (C)	i Inlet (in/hr)	Incr Q (cfs)	Q Carry (cfs)	Q Capt (cfs)	Q Bypass (cfs)	Gutter Spread (ft)	Inlet Spread (ft)
49	149		Comb.	0.670	0.70	4.00	1.88	0.00	1.43	0.45	5.13	4.09
50	150		Comb.	0.390	0.70	4.00	1.09	0.00	1.09	0.00	3.46	3.46
51	151		Comb.	0.190	0.70	4.00	0.53	0.11	0.65	0.00	2.46	2.46
52	152		Comb.	0.040	0.80	4.00	0.13	0.10	0.22	0.01	2.82	1.48
53	153		Comb.	0.220	0.70	4.00	0.62	0.17	0.68	0.10	4.05	2.72
54	154		Comb.	0.350	0.70	4.00	0.98	0.03	0.84	0.17	4.38	3.17
55	155		Comb.	0.090	0.80	4.00	0.29	0.15	0.41	0.03	3.40	1.90
56	156		Comb.	0.350	0.70	4.00	0.98	0.00	0.83	0.15	4.35	3.12
57	157		Comb.	0.270	0.70	4.00	0.76	0.00	0.66	0.10	4.00	2.64
58	158		Dp-Curb	8.600	0.50	4.00	17.20	0.00	17.20	0.00	5.03	5.03
59	159		Comb.	0.210	0.70	4.00	0.59	0.00	0.53	0.06	3.70	2.24
60	160		Comb.	0.290	0.70	4.00	0.81	0.00	0.71	0.11	4.10	2.77
61	161		Dp-Curb	3.070	0.60	4.00	7.37	0.00	7.37	0.00	7.12	7.12
62	162		Comb.	0.290	0.70	4.00	0.81	0.00	0.71	0.11	4.10	2.77
63	163		Comb.	0.170	0.70	4.00	0.48	0.00	0.44	0.04	3.70	2.22
64	164		Comb.	0.330	0.70	4.00	0.92	0.00	0.78	0.14	4.55	3.37
65	165		Dp-Curb	0.340	0.60	4.00	0.82	0.00	0.82	0.00	1.26	1.63
66	166		Dp-Curb	0.001	0.60	4.00	0.00	0.00	0.00	0.00	0.00	0.03
67	167		Dp-Curb	1.850	0.55	4.00	4.07	0.00	4.07	0.00	4.79	4.79
68	168		Dp-Curb	4.540	0.55	4.00	9.99	1.23	11.22	0.00	3.78	3.78
69	169		MH	0.010	0.75	4.00	0.03
70	170		MH	0.350	0.65	4.00	0.91
71	171		MH	0.001	0.75	4.00	0.00
72	172		Dp-Grate	0.400	0.75	4.00	1.20	0.82	0.97	1.05	8.00	8.00

Notes: IDF File = Gutter Spread - 4 inches per hour.idf, Return Period = 2-yrs.

Project File: PRESERVE AT JONES DAIRY CENTRAL - STORM DRAINAGE SYSTEM 0100.sws

Spread Report

Stormwater Studio 2024 v 3.0.0.33

Project Name: Enter Project Name...

01-19-2024

Line No.	Inlet ID	Area ID	Junct Type	Drain Area (ac)	Runoff Coeff (C)	i Inlet (in/hr)	Incr Q (cfs)	Q Carry (cfs)	Q Capt (cfs)	Q Bypass (cfs)	Gutter Spread (ft)	Inlet Spread (ft)
73	173		Comb.	0.340	0.75	4.00	1.02	0.00	0.86	0.16	4.40	3.17
74	174		Comb.	0.340	0.75	4.00	1.02	0.26	1.28	0.00	3.96	3.96
75	175		Comb.	0.360	0.75	4.00	1.08	0.23	1.05	0.26	5.10	4.07
76	176		Comb.	0.410	0.75	4.00	1.23	0.00	1.00	0.23	5.00	3.94
77	177		MH	0.001	0.75	4.00	0.00
78	178		Comb.	0.170	0.75	4.00	0.51	0.00	0.46	0.05	3.78	2.32
79	179		Comb.	0.540	0.75	4.00	1.62	0.40	2.02	0.00	5.46	5.46
80	180		Dp-Grate	0.470	0.75	4.00	1.41	0.35	1.35	0.40	4.80	4.80
81	181		Dp-Grate	0.470	0.75	4.00	1.41	0.21	1.27	0.35	4.80	4.80
82	182		Dp-Curb	0.230	0.65	4.00	0.60	0.00	0.60	0.00	0.65	1.32
83	188		Dp-Curb	0.220	0.60	4.00	0.53	0.00	0.53	0.00	0.44	1.22
84	187		Dp-Curb	0.240	0.65	4.00	0.62	0.00	0.62	0.00	0.72	1.36
85	186		Dp-Curb	0.790	0.60	4.00	1.90	0.00	1.90	0.00	2.87	2.87
86	185		Dp-Curb	0.590	0.60	4.00	1.42	0.00	1.42	0.00	2.36	2.36
87	184		Dp-Curb	0.430	0.60	4.00	1.03	0.00	1.03	0.00	1.82	1.91
88	183		Dp-Curb	0.300	0.60	4.00	0.72	0.00	0.72	0.00	1.00	1.50
89	189		Dp-Grate	0.470	0.75	4.00	1.41	0.03	0.78	0.66	7.50	7.50
90	190		MH	0.010	0.75	4.00	0.03
91	191		MH	0.001	0.80	4.00	0.00
92	192		Dp-Grate	0.400	0.75	4.00	1.20	0.31	1.22	0.29	5.00	5.00
93	193		Dp-Grate	0.400	0.75	4.00	1.20	0.40	1.30	0.31	5.20	5.20
94	194		Dp-Grate	0.630	0.75	4.00	1.89	0.00	1.49	0.40	5.40	5.40
95	195		MH	0.001	0.75	4.00	0.00
96	196		Comb.	0.340	0.70	4.00	0.95	0.00	0.95	0.00	3.21	3.21

Notes: IDF File = Gutter Spread - 4 inches per hour.idf, Return Period = 2-yrs.

Project File: PRESERVE AT JONES DAIRY CENTRAL - STORM DRAINAGE SYSTEM 0100.sws

Spread Report

Stormwater Studio 2024 v 3.0.0.33

Project Name: Enter Project Name...

01-19-2024

Line No.	Inlet ID	Area ID	Junct Type	Drain Area (ac)	Runoff Coeff (C)	i Inlet (in/hr)	Incr Q (cfs)	Q Carry (cfs)	Q Capt (cfs)	Q Bypass (cfs)	Gutter Spread (ft)	Inlet Spread (ft)
97	197		Comb.	1.240	0.70	4.00	3.47	0.49	3.96	0.00	6.46	6.46
98	198		Comb.	0.740	0.70	4.00	2.07	0.00	1.58	0.49	4.85	3.74
99	199		Dp-Curb	0.380	0.65	4.00	0.99	0.00	0.99	0.00	1.71	1.85
100	200		Dp-Curb	0.060	0.60	4.00	0.14	0.00	0.14	0.00	0.00	0.51
101	201		Dp-Curb	0.370	0.65	4.00	0.96	0.00	0.96	0.00	1.64	1.82
102	202		Dp-Curb	0.280	0.65	4.00	0.73	0.00	0.73	0.00	1.02	1.51
103	203		Dp-Curb	0.050	0.60	4.00	0.12	0.00	0.12	0.00	0.00	0.45
104	204		Dp-Curb	0.370	0.65	4.00	0.96	0.00	0.96	0.00	1.64	1.82
105	205		Dp-Curb	0.060	0.60	4.00	0.14	0.00	0.14	0.00	0.00	0.51
106	206		Dp-Curb	0.060	0.60	4.00	0.14	0.00	0.14	0.00	0.00	0.51
107	207		Dp-Grate	0.660	0.70	4.00	1.85	0.81	2.65	0.00	5.97	5.97
108	208		Dp-Grate	0.410	0.75	4.00	1.23	0.28	0.71	0.81	6.50	6.50
109	209		Dp-Grate	0.220	0.75	4.00	0.66	0.00	0.38	0.28	5.00	5.00
110	210		MH	0.001	0.70	4.00	0.00
111	211		Dp-Grate	0.380	0.75	4.00	1.14	0.00	0.93	0.21	4.20	4.20
112	212		Dp-Curb	0.240	0.65	4.00	0.62	0.00	0.62	0.00	0.72	1.36
113	213		Dp-Grate	0.470	0.75	4.00	1.41	0.00	1.13	0.28	4.60	4.60
114	213A		Dp-Curb	0.470	0.75	4.00	1.41	0.00	1.41	0.00	5.09	5.09
115	214		Dp-Grate	0.320	0.75	4.00	0.96	0.00	0.53	0.43	6.00	6.00
116	215		Comb.	0.270	0.75	4.00	0.81	0.00	0.81	0.00	2.96	2.96
117	216		Dp-Curb	0.060	0.60	4.00	0.14	0.00	0.14	0.00	0.00	0.51
118	217		Dp-Curb	0.180	0.60	4.00	0.43	0.00	0.43	0.00	0.13	1.06
119	218		Dp-Curb	0.060	0.60	4.00	0.14	0.00	0.14	0.00	2.21	2.21
120	219		Dp-Curb	0.250	0.65	4.00	0.65	0.00	0.65	0.00	0.80	1.40

Notes: IDF File = Gutter Spread - 4 inches per hour.idf, Return Period = 2-yrs.

Project File: PRESERVE AT JONES DAIRY CENTRAL - STORM DRAINAGE SYSTEM 0100.sws

Spread Report

Stormwater Studio 2024 v 3.0.0.33

Project Name: Enter Project Name...

01-19-2024

Line No.	Inlet ID	Area ID	Junct Type	Drain Area (ac)	Runoff Coeff (C)	i Inlet (in/hr)	Incr Q (cfs)	Q Carry (cfs)	Q Capt (cfs)	Q Bypass (cfs)	Gutter Spread (ft)	Inlet Spread (ft)
121	220	220	Dp-Curb	0.140	0.65	4.00	0.36	0.00	0.36	0.00	0.00	0.95
122	221	221	Dp-Curb	1.120	0.60	4.00	2.69	0.00	2.69	0.00	3.62	3.62
123	222	222	Dp-Curb	0.060	0.60	4.00	0.14	0.00	0.14	0.00	0.00	0.51
124	223	223	Dp-Curb	0.750	0.65	4.00	1.95	0.00	1.95	0.00	2.92	2.92
125	314	314	Comb.	0.300	0.70	4.00	0.84	0.00	0.84	0.00	2.96	2.96
126	213B	213B	Dp-Curb	0.260	0.60	4.00	0.62	0.00	0.62	0.00	5.89	5.89

Notes: IDF File = Gutter Spread - 4 inches per hour.idf, Return Period = 2-yrs.

Project File: PRESERVE AT JONES DAIRY CENTRAL - STORM DRAINAGE SYSTEM 0100.sws

Spread Report

Stormwater Studio 2023 v 3.0.0.31

Project Name: Enter Project Name...

05-03-2023

Line No.	Inlet ID	Area ID	Junct Type	Drain Area (ac)	Runoff Coeff (C)	i Inlet (in/hr)	Incr Q (cfs)	Q Carry (cfs)	Q Capt (cfs)	Q Bypass (cfs)	Gutter Spread (ft)	Inlet Spread (ft)
1	301	301	Comb.	0.120	0.70	5.52	0.46	0.01	0.44	0.03	3.48	1.95
2	318	318	Dp-Curb	0.470	0.65	5.52	1.69	0.55	2.23	0.00	3.20	3.20
3	319	319	Dp-Curb	0.770	0.65	5.52	2.76	0.00	2.76	0.00	3.69	3.69
4	320	320	Dp-Curb	0.710	0.65	5.52	2.55	0.00	2.55	0.00	3.50	3.50
5	302	302	Comb.	0.030	0.70	5.52	0.12	0.12	0.23	0.01	2.85	1.51
6	303	303	Comb.	0.001	0.70	5.52	0.00	0.00	0.00	0.00	0.80	0.33
7	304	304	Comb.	0.060	0.70	5.52	0.23	0.00	0.23	0.01	2.80	1.46
8	305	305	Comb.	0.190	0.70	5.52	0.73	0.00	0.74	0.00	2.71	2.71
9	306	306	Comb.	0.030	0.70	5.52	0.12	0.00	0.12	0.00	2.52	1.25
10	307	307	Comb.	0.170	0.70	5.52	0.66	0.00	0.66	0.00	2.46	2.46
11	308	308	Comb.	0.210	0.70	5.52	0.81	0.15	0.96	0.00	3.21	3.21
12	309	309	Comb.	0.140	0.70	5.52	0.54	0.02	0.51	0.05	3.90	2.49
13	363	363	Comb.	0.150	0.70	5.52	0.58	0.00	0.52	0.06	3.93	2.54
14	310	310	Comb.	0.080	0.70	5.52	0.31	0.06	0.35	0.02	3.43	1.92
15	311	311	Comb.	0.130	0.70	5.52	0.50	0.09	0.53	0.06	3.95	2.57
16	312	312	Comb.	0.090	0.70	5.52	0.35	0.37	0.63	0.09	4.20	2.89
17	364	364	Comb.	0.260	0.70	5.52	1.01	0.66	1.30	0.37	4.93	3.84
18	365	365	Comb.	0.600	0.70	5.52	2.32	0.09	1.75	0.66	5.58	4.64
19	313	313	Comb.	0.540	0.70	5.52	2.09	0.00	1.54	0.55	5.98	5.09
20	360	360	Comb.	0.100	0.70	5.52	0.39	0.37	0.66	0.09	3.83	2.39
21	361	361	Comb.	0.430	0.70	5.52	1.66	0.00	1.30	0.37	4.93	3.84
22	362	362	Dp-Curb	0.570	0.60	5.52	1.89	0.00	1.89	0.00	2.86	2.86
23	356	356	MH	0.001	0.70	5.52	0.00
24	357	357	Dp-Curb	0.840	0.65	5.52	3.02	0.00	3.02	0.00	3.91	3.91

Notes: IDF File = RDU-Rainfall Intensity.idf, Return Period = 2-yrs.

Project File: PRESERVE AT JONES DAIRY CENTRAL - STORM DRAINAGE SYSTEM 0300.sws

Spread Report

Stormwater Studio 2023 v 3.0.0.31

Project Name: Enter Project Name...

05-03-2023

Line No.	Inlet ID	Area ID	Junct Type	Drain Area (ac)	Runoff Coeff (C)	i Inlet (in/hr)	Incr Q (cfs)	Q Carry (cfs)	Q Capt (cfs)	Q Bypass (cfs)	Gutter Spread (ft)	Inlet Spread (ft)
25	358		Dp-Curb	0.310	0.65	5.52	1.11	0.00	1.11	0.00	2.01	2.01
26	359		Dp-Curb	0.220	0.65	5.52	0.79	0.00	0.79	0.00	1.19	1.60
27	355		Comb.	0.630	0.70	5.52	2.44	0.00	2.44	0.00	5.96	5.96
28	338		Comb.	0.370	0.70	5.52	1.43	0.00	1.43	0.00	4.21	4.21
29	339		Comb.	0.140	0.70	5.52	0.54	0.40	0.95	0.00	3.21	3.21
30	340		Comb.	0.320	0.70	5.52	1.24	0.50	1.33	0.40	5.08	4.04
31	341		Comb.	0.230	0.70	5.52	0.89	0.00	0.77	0.12	4.10	2.77
32	342		Comb.	0.180	0.70	5.52	0.70	0.00	0.61	0.09	4.15	2.87
33	343		Comb.	0.080	0.70	5.52	0.31	0.07	0.35	0.02	3.45	1.93
34	343A		Comb.	0.120	0.70	5.52	0.46	0.00	0.43	0.04	3.68	2.17
35	344		Comb.	0.090	0.70	5.52	0.35	0.08	0.39	0.03	3.58	2.04
36	345		Comb.	0.130	0.70	5.52	0.50	0.16	0.59	0.08	4.10	2.79
37	346		Comb.	0.230	0.70	5.52	0.89	0.13	0.85	0.16	4.70	3.54
38	347		Comb.	0.170	0.70	5.52	0.66	0.14	0.69	0.11	4.35	3.09
39	348		Comb.	0.220	0.70	5.52	0.85	0.01	0.74	0.13	4.38	3.17
40	349		Comb.	0.080	0.70	5.52	0.31	0.00	0.30	0.01	3.23	1.76
41	354		Comb.	0.080	0.70	5.52	0.31	0.00	0.30	0.01	3.23	1.76
42	353		Comb.	0.090	0.70	5.52	0.35	0.00	0.33	0.02	3.33	1.84
43	351		Comb.	0.190	0.70	5.52	0.73	0.00	0.73	0.00	2.71	2.71
44	315		MH	0.000	0.00	0.00	0.00
45	316		Dp-Curb	0.550	0.65	5.52	1.97	0.00	1.97	0.00	6.37	6.37
46	317		Dp-Curb	0.700	0.65	5.52	2.51	0.00	2.51	0.00	7.49	7.49
47	350		Comb.	0.430	0.70	5.52	1.66	0.00	1.28	0.38	5.45	4.47
48	333		Dp-Curb	0.170	0.65	5.52	0.61	0.00	0.61	0.00	0.68	1.34

Notes: IDF File = RDU-Rainfall Intensity.idf, Return Period = 2-yrs.

Project File: PRESERVE AT JONES DAIRY CENTRAL - STORM DRAINAGE SYSTEM 0300.sws

Spread Report

Stormwater Studio 2023 v 3.0.0.31

Project Name: Enter Project Name...

05-03-2023

Line No.	Inlet ID	Area ID	Junct Type	Drain Area (ac)	Runoff Coeff (C)	i Inlet (in/hr)	Incr Q (cfs)	Q Carry (cfs)	Q Capt (cfs)	Q Bypass (cfs)	Gutter Spread (ft)	Inlet Spread (ft)
49	334	334	Dp-Curb	0.370	0.65	5.52	1.33	0.00	1.33	0.00	2.26	2.26
50	335	335	Dp-Curb	0.270	0.65	5.52	0.97	0.00	0.97	0.00	1.66	1.83
51	336	336	Dp-Curb	0.170	0.65	5.52	0.61	0.00	0.61	0.00	0.68	1.34
52	337	337	Dp-Curb	0.760	0.65	5.52	2.73	0.00	2.73	0.00	3.66	3.66
53	322	322	Comb.	0.130	0.70	5.52	0.50	0.03	0.53	0.00	2.21	2.21
54	323	323	Comb.	0.580	0.70	5.52	2.24	0.42	2.66	0.00	6.46	6.46
55	324	324	Comb.	0.390	0.70	5.52	1.51	0.25	1.34	0.42	5.55	4.59
56	325	325	Comb.	0.330	0.70	5.52	1.28	0.00	1.03	0.25	4.98	3.92
57	326	326	MH	0.001	0.70	5.52	0.00
58	327	327	Comb.	0.570	0.70	5.52	2.20	0.00	2.20	0.00	5.71	5.71
59	328	328	Comb.	0.920	0.65	5.52	3.30	0.00	3.31	0.00	7.46	7.46
60	329	329	MH	0.001	0.70	5.52	0.00
61	330	330	Dp-Curb	6.620	0.50	5.52	18.28	0.00	18.28	0.00	5.24	5.24
62	332	332	Comb.	0.230	0.70	5.52	0.89	0.00	0.76	0.13	4.43	3.22
63	331	331	Comb.	0.110	0.70	5.52	0.43	0.00	0.39	0.03	3.53	1.98
64	321	321	Comb.	0.220	0.70	5.52	0.85	0.00	0.73	0.12	4.15	2.84
65	366	366	Comb.	0.180	0.70	5.52	0.70	0.15	0.84	0.00	2.96	2.96
66	367	367	Comb.	0.210	0.70	5.52	0.81	0.18	0.84	0.15	4.18	2.87
67	368	368	Comb.	0.280	0.70	5.52	1.08	0.00	0.90	0.18	4.28	3.02
68	369	369	Comb.	0.660	0.70	5.52	2.55	0.13	2.69	0.00	6.46	6.46
69	370	370	Comb.	0.270	0.70	5.52	1.04	0.00	0.91	0.13	3.68	2.19
70	374	374	Comb.	0.280	0.70	5.52	1.08	0.00	1.08	0.00	3.46	3.46
71	373	373	Comb.	0.250	0.70	5.52	0.97	0.00	0.82	0.15	4.13	2.82
72	372	372	Comb.	0.320	0.70	5.52	1.24	0.00	1.02	0.22	4.48	3.27

Notes: IDF File = RDU-Rainfall Intensity.idf, Return Period = 2-yrs.

Project File: PRESERVE AT JONES DAIRY CENTRAL - STORM DRAINAGE SYSTEM 0300.sws

Spread Report

Stormwater Studio 2023 v 3.0.0.31

Project Name: Enter Project Name...

05-03-2023

Line No.	Inlet ID	Area ID	Junct Type	Drain Area (ac)	Runoff Coeff (C)	i Inlet (in/hr)	Incr Q (cfs)	Q Carry (cfs)	Q Capt (cfs)	Q Bypass (cfs)	Gutter Spread (ft)	Inlet Spread (ft)
73	371	371	Comb.	0.330	0.70	5.52	1.28	0.00	1.28	0.00	3.96	3.96

Notes: IDF File = RDU-Rainfall Intensity.idf, Return Period = 2-yrs.

Project File: PRESERVE AT JONES DAIRY CENTRAL - STORM DRAINAGE SYSTEM 0300.sws

Spread Report

Stormwater Studio 2022 v 3.0.0.29

Project Name: Enter Project Name...

12-12-2022

Line No.	Inlet ID	Area ID	Junct Type	Drain Area (ac)	Runoff Coeff (C)	i Inlet (in/hr)	Incr Q (cfs)	Q Carry (cfs)	Q Capt (cfs)	Q Bypass (cfs)	Gutter Spread (ft)	Inlet Spread (ft)
1	401	401	MH	0.001	0.75	4.00	0.00
2	402	402	Comb.	0.100	0.90	4.00	0.36	0.00	0.36	0.00	1.42	1.86
3	403	403	Comb.	0.270	0.75	4.00	0.81	0.00	0.81	0.00	2.96	2.96
4	404	404	Comb.	0.700	0.60	4.00	1.68	0.00	1.68	0.00	4.71	4.71
5	405	405	Hdwall	0.870	0.60	4.00	2.09	0.00	2.09	0.00
6	406	406	Hdwall	17.200	0.40	4.00	27.52	0.00	27.52	0.00

Notes: IDF File = Gutter Spread - 4 inches per hour.idf, Return Period = 10-yrs.

Project File: PRESERVE AT JONES DAIRY CENTRAL - STORM DRAINAGE SYSTEM 0400.sws