







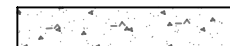

**LEGEND**

-  PROPERTY LINE
-  ROADWAY CENTERLINE
-  EASEMENT / SETBACK LINE
-  CONCRETE SIDEWALK
-  DUMPSTER PAD / HEAVY DUTY CONCRETE
-  HEAVY DUTY ASPHALT PAVING
-  EXISTING CONCRETE SIDEWALK
-  BIKE RACK
-  SIGN
-  LIGHT POLE LOCATION

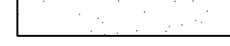

TRI ARC FOOD SYSTEMS INC  
 N/F  
 PIN# 1758465402  
 REID# 0376995  
 DB 13702, PG 1125  
 BM 2009, PG 1043 [LOT 1]

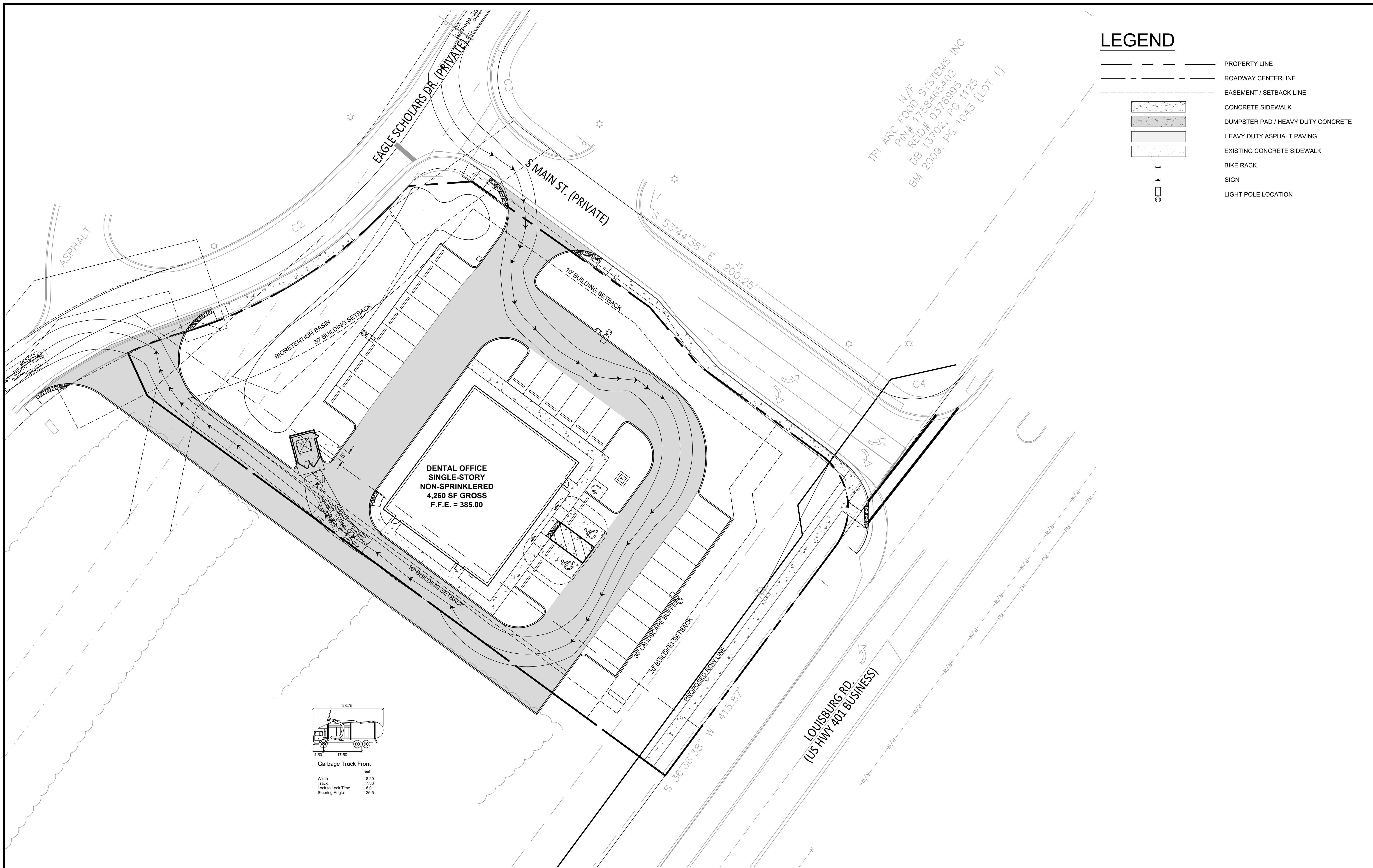
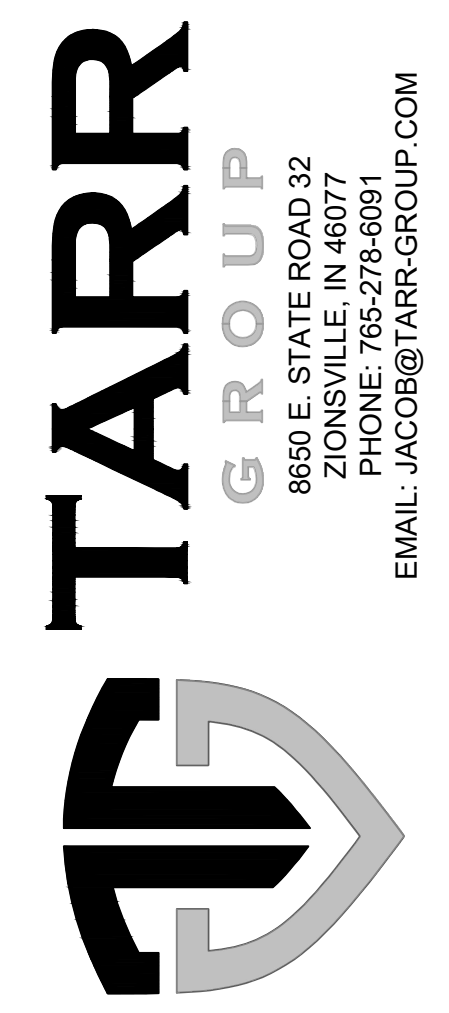
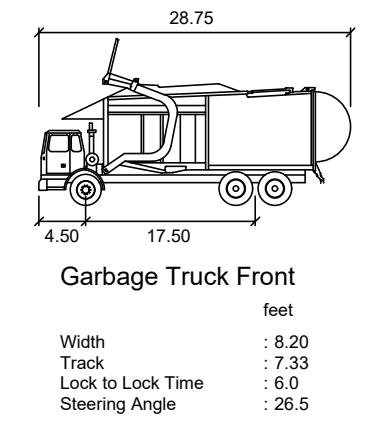

8650 E. STATE ROAD 32  
 ZIONSVILLE, IN 46077  
 PHONE: 765-226-0897  
 EMAIL: JACO@TARR-GROUP.COM

ROLESVILLE DENTAL OFFICE  
 WMG DEVELOPMENT, LLC  
 NORTH OF HAMPTON LAKE DR. & LOUISBURG RD.  
 ROLESVILLE, N.C.

ORIGINAL ISSUE DATE: 01/05/22

REVISIONS:

△ REVISION 1	03/28/2022

PROJ. NO.: 21040

DUMP TRUCK EXHIBIT

**EX B**

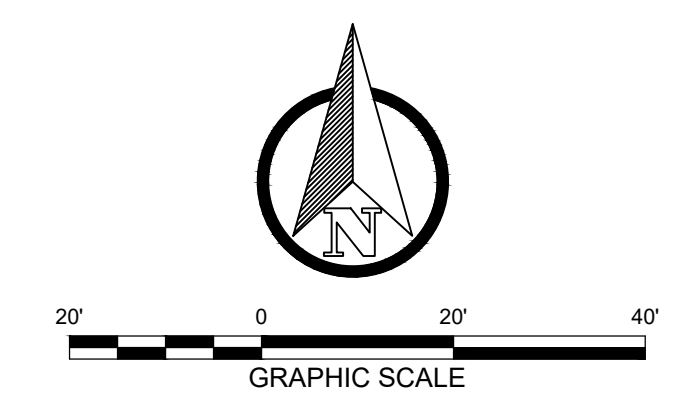

21040 - Dump Truck Exhibit.dwg

IF THIS SHEET DOES NOT MEASURE 24"x36" IT HAS BEEN ENLARGED OR REDUCED. PLEASE ADJUST SCALE ACCORDINGLY.